



**EN** Operating instructions. . . . .pages 1 to 6  
Translation of the original operating instructions

**Content**

**1 About this document**

1.1 Function . . . . . 1

1.2 Target group: authorised qualified personnel. . . . . 1

1.3 Explanation of the symbols used . . . . . 1

1.4 Appropriate use . . . . . 1

1.5 General safety instructions . . . . . 1

1.6 Warning about misuse . . . . . 1

1.7 Exclusion of liability . . . . . 2

**2 Product description**

2.1 Ordering code . . . . . 2

2.2 Special versions. . . . . 2

2.3 Destination and use . . . . . 2

2.4 Technical data . . . . . 3

2.5 Safety classification . . . . . 3

**3 Mounting**

3.1 General mounting instructions . . . . . 3

3.2 Dimensions . . . . . 3

**4 Electrical connection**

4.1 General information for electrical connection. . . . . 4

4.2 Contact variants. . . . . 4

**5 Set-up and maintenance**

5.1 Functional testing. . . . . 5

5.2 Maintenance . . . . . 5

**6 Disassembly and disposal**

6.1 Disassembly. . . . . 5

6.2 Disposal. . . . . 5

**7 EU Declaration of conformity**

**1. About this document**

**1.1 Function**

This operating instructions manual provides all the information you need for the mounting, set-up and commissioning to ensure the safe operation and disassembly of the safety switchgear. The operating instructions must be available in a legible condition and a complete version in the vicinity of the device.

**1.2 Target group: authorised qualified personnel**

All operations described in this operating instructions manual must be carried out by trained specialist personnel, authorised by the plant operator only.

Please make sure that you have read and understood these operating instructions and that you know all applicable legislations regarding occupational safety and accident prevention prior to installation and putting the component into operation.

The machine builder must carefully select the harmonised standards to be complied with as well as other technical specifications for the selection, mounting and integration of the components.

**1.3 Explanation of the symbols used**



**Information, hint, note:**

This symbol is used for identifying useful additional information.



**Caution:** Failure to comply with this warning notice could lead to failures or malfunctions.

**Warning:** Failure to comply with this warning notice could lead to physical injury and/or damage to the machine.

**1.4 Appropriate use**

The products described in these operating instructions are developed to execute safety-related functions as part of an entire plant or machine. It is the responsibility of the manufacturer of a machine or plant to ensure the correct functionality of the entire machine or plant.

The safety switchgear must be exclusively used in accordance with the versions listed below or for the applications authorised by the manufacturer. Detailed information regarding the range of applications can be found in the chapter "Product description".

**1.5 General safety instructions**

The user must observe the safety instructions in this operating instructions manual, the country-specific installation standards as well as all prevailing safety regulations and accident prevention rules.



Further technical information can be found in the Schmersal catalogues or in the online catalogue on the Internet: [www.schmersal.net](http://www.schmersal.net).

The information contained in this operating instructions manual is provided without liability and is subject to technical modifications.

There are no residual risks, provided that the safety instructions as well as the instructions regarding mounting, commissioning, operation and maintenance are observed.

**1.6 Warning about misuse**



In case of improper use or manipulation of the safety switchgear, personal hazards or damages to machinery or plant components cannot be excluded when safety switchgear is used. The relevant requirements of the standard ISO 14119 must be observed.

### 1.7 Exclusion of liability

We shall accept no liability for damages and malfunctions resulting from defective mounting or failure to comply with this operating instructions manual. The manufacturer shall accept no liability for damages resulting from the use of unauthorised spare parts or accessories.

For safety reasons, invasive work on the device as well as arbitrary repairs, conversions and modifications to the device are strictly forbidden; the manufacturer shall accept no liability for damages resulting from such invasive work, arbitrary repairs, conversions and/or modifications to the device.

## 2. Product description

### 2.1 Ordering code

This operating instructions manual applies to the following types:

**AZM 161** ①-②③ K④-⑤/⑥-⑦⑧

No.	Option	Description
①	CC	Cage clamps
	SK	Screw connection
	ST	Connector plug M 12
②	11/03	1 NO / 4 NC with connector plug
	11/12	2 NO / 3 NC with connector plug
	12/03	1 NO / 5 NC
	12/11	2 NO / 3 NC with connector plug
	12/12	2 NO / 4 NC
③	R	Latching force 5 N
		Latching force 30 N
④		Power to unlock
	A	Power to lock
⑤		Lateral manual release
	ED	Manual release on the cover side
	EU	Manual release on the rear side
⑥	T	Lateral emergency exit
	TD	Emergency exit on the cover side
	TU	Emergency exit on the rear side
	N	Emergency release
⑦	024	U <sub>s</sub> 24 VAC/DC
	110/230	U <sub>s</sub> 110/230 VAC
⑧		Without LED
	G	With LED



Only if the information described in this operating instructions manual are realised correctly, the safety function and therefore the compliance with the Machinery Directive is maintained.

### 2.2 Special versions

For special versions, which are not listed in the order code below 2.1, these specifications apply accordingly, provided that they correspond to the standard version.

### 2.3 Destination and use

The solenoid interlock has been designed to prevent in conjunction with the control part of a machine, movable safety guards from being opened before hazardous conditions have been eliminated.



Interlocks with the power to lock principle may only be used in special cases after a thorough evaluation of the accident risk, since the guarding device can immediately be opened on failure of the electrical power supply or when the main switch is opened.



The safety switchgears are classified according to ISO 14119 as type 2 interlocking devices.

### Manual release

(for set-up, maintenance, etc.)

The manual release is realised by turning the triangular key (M5 triangular key available as accessory), so that the locking bolt is pulled into the unlocking position. Please ensure that jamming by external influence on the actuator is avoided. The normal locking function is only restored after the triangular key has been returned to its original position. After being put into operation, the manual release must be secured by installing the plastic cover, which is included in delivery.

### Lateral manual release

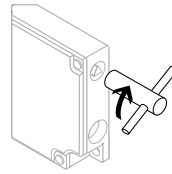

### Manual release on the cover side or on the rear side (ordering suffix -ED/-EU)

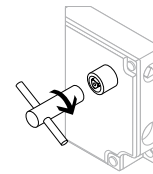

Triangular key TK-M5 (101100887) available as accessory.

### Emergency release (ordering suffix -N)

(Mounting and actuation only outside of the safety guard)



The emergency release should only be used in an emergency. The solenoid interlock should be installed and/or protected so that an inadvertent opening of the interlock by an emergency release can be prevented. The emergency release must be clearly labelled that it should only be used in an emergency. The label can be used that was included in the delivery.

To activate the emergency release in case of an emergency, the orange lever must be turned to the stop in the direction marked by the arrow. In this position, the safety guard can be opened. The lever is latched and cannot be returned to its original position. To cancel the blocking condition, the central mounting screw must be loosened to such extent that the lever can be turned back into its original position. The screw must then be re-tightened.

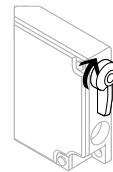

### Emergency exit

(Fitting and actuation only from within the hazardous area)

To activate the emergency exit of the T version in case of an emergency, the orange lever must be turned to the stop in direction marked by the arrow. The emergency exit function of the TD and TU versions is activated by pressing the red pushbutton. In this position, the safety guard can be opened. The blocking condition is cancelled by turning the lever in opposite direction or by pulling back the pushbutton. In unlocked position, the safety guard is protected against unintentional closing.

### Lateral emergency exit (ordering suffix -T)

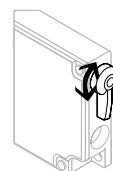

### Emergency exit on the cover side or on the rear side (ordering suffix -TD/-TU)

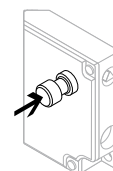



The entire concept of the control system, in which the safety component is integrated, must be validated to the relevant standards.



The user must evaluate and design the safety chain in accordance with the relevant standards and the required safety level.

### 2.4 Technical data

Standards:	IEC 60947-5-1, ISO 14119, BG-GS-ET-19
Enclosure:	glass-fibre reinforced thermo-plastic, self-extinguishing
Actuator and locking bolt:	stainless steel 1.4301
Contact material:	Silver
Coding level according to ISO 14119:	low
Protection class:	IP67
Contact type:	Change-over with double break Zb, galvanically separated contact bridges
Switching system:	⊖ acc. IEC 60947-5-1 slow action, NC contact with positive break
Positive break travel:	10 mm
Positive break force:	10 N for each NC contact fitted
Connection:	screw terminals or cage clamps or connector plug
Cable type:	flexible
Cable section:	min. 0.25 mm <sup>2</sup> , max. 1.5 mm <sup>2</sup> (including conductor ferrules)
Cable entry:	4 x M16
Holding force F:	2000 N
Latching force:	30 N for ordering suffix R
Actuating speed:	max. 2 m/s
Actuating frequency:	max. 1000 operations/h
Mechanical life:	> 1 million operations
Ambient temperature:	-25 °C ... +60 °C
<b>Electrical data:</b>	
Utilisation category:	AC-15, DC-13
Rated operating current/voltage I <sub>N</sub> /U <sub>N</sub> :	CC, SK, ST 4-pole: 4 A / 230 VAC; 2.5 A / 24 VDC; ST 8-pole: 2 A / 24 VDC
Rated impulse withstand voltage U <sub>imp</sub> :	CC, SK, ST 4-pole: 4 kV; ST 8-pole: 0.8 kV
Rated insulation voltage U <sub>i</sub> :	CC, SK, ST 4-pole: 250 V; ST 8-pole: 60 V
Thermal test current I <sub>the</sub> :	CC, SK, ST 4-pole: 6 A; ST 8-pole: 2 A
Rated control voltage U <sub>s</sub> :	24 VAC/DC; 110/230 VAC
Magnet:	100% ED
Power consumption:	max. 10 W
Max. fuse rating:	6 A gG D-fuse
Required rated short-circuit current:	1000 A



Use Type 4X (Indoor Use) and 12 connector fittings.  
Tightening torque rating: 4.4 lb in.

### 2.5 Safety classification

Standards:	ISO 13849-1
Envisaged structure:	
- Basically:	applicable up to Cat. 1 / PL c
- With 2-channel usage and fault exclusion mechanism*:	applicable up to Cat. 3 / PL d with suitable logic unit
B <sub>10d</sub> NC contact:	2,000,000
B <sub>10d</sub> NO contact at 10% ohmic contact load:	1,000,000
Service life:	20 years

\* If a fault exclusion to the 1-channel mechanics is authorised.

$$MTTF_d = \frac{B_{10d}}{0,1 \times n_{op}} \quad n_{op} = \frac{d_{op} \times h_{op} \times 3600 \text{ s/h}}{t_{cycle}}$$

(Determined values can vary depending on the application-specific parameters h<sub>op</sub>, d<sub>op</sub> and t<sub>cycle</sub> as well as the load.)

If multiple safety components are wired in series, the Performance Level to ISO 13849-1 will be reduced due to the restricted error detection under certain circumstances.

## 3. Mounting

### 3.1 General mounting instructions

Three mounting holes are provided for fixing the enclosure. The solenoid interlock is double insulated. The use of an earth wire is not authorised. The solenoid interlock must not be used as an end stop. Any mounting position. The mounting position however must be chosen so that the ingress of dirt and soiling in the used opening is avoided. Unused actuator openings must be sealed with slot sealing plugs.



The safety component and the actuator must be permanently fitted to the safety guards and protected against displacement by suitable measures (tamperproof screws, gluing, drilling, pinning).



Please observe the remarks of the standards ISO 12100, EN 953 and ISO 14119.

### 3.2 Dimensions

All measurements in mm.

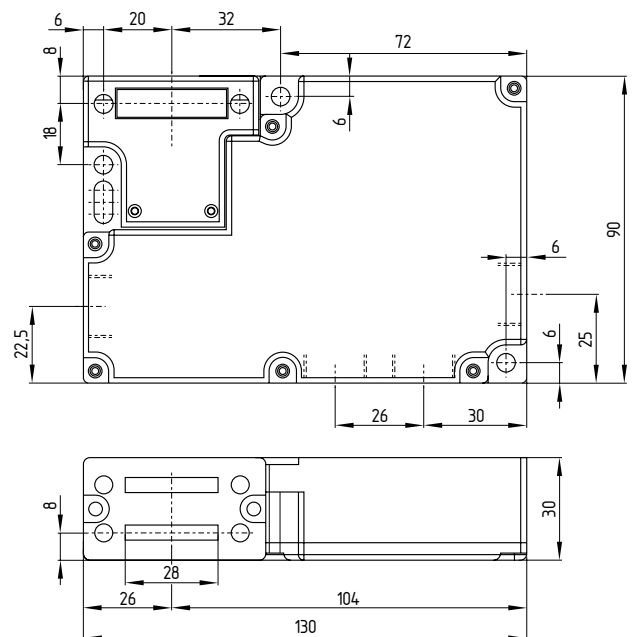

## 4. Electrical connection

### 4.1 General information for electrical connection



The electrical connection may only be carried out by authorised personnel in a de-energised condition.



If the risk analysis indicates the use of a monitored interlock they are to be connected in the safety circuit with the contacts indicated with the symbol

Appropriate cable glands with a suitable degree of protection are to be used. Remove the thin walls of the mounting holes by inserting the cable entry.

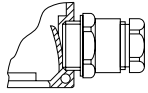

Puncturing the wall of the holes with auxiliary tools (e.g. screwdriver) can cause damage.

### 4.2 Contact variants

Contacts are shown in the de-energised condition and with the actuator inserted.

#### Power to unlock

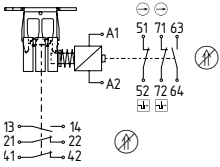

#### Power to lock

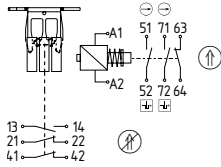

#### AZM 161SK-12/12...

#### AZM 161CC-12/12...

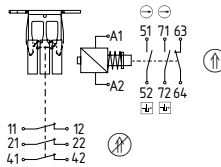
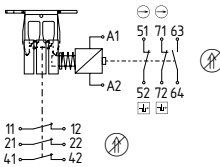
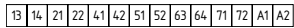

#### AZM 161SK-12/03...

#### AZM 161CC-12/03...

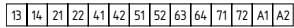

#### Key

- Positive break NC contact
- Monitoring the interlock according to ISO 14119
- Actuated
- Not actuated

### AZM 161ST-../.. with connector

#### AZM 161ST-12/11...

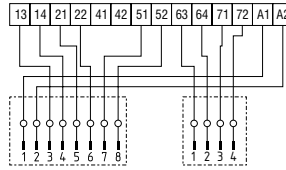

#### AZM 161ST-11/12...

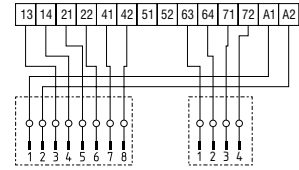

#### AZM 161ST-11/03...

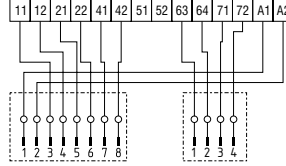

### AZM 161...-G with LED

The contacts are shown in closed and locked condition.

#### AZM 161SK-12/12...G

#### AZM 161CC-12/12...G

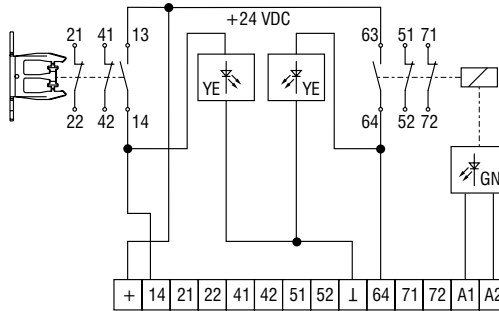

#### Key

- 14: guard open
- +: +24 VDC
- ⊥: 0 VDC
- 64: unlocked

System condition	Solenoid control		LED		Contacts							
	Power to unlock	green LED	Power to lock	green LED	yellow actuator	yellow magnet	21-22	41-42	13-14	63-64	51-52	71-72
Safety guard open	24V	●	0V	○	○	○	-	-	On	On	-	-
Guard closed, actuator inserted (not locked)	24V	●	0V	○	●	○	On	On	-	On	-	-
Guard closed, actuator inserted and locked	0V	○	24V	●	●	●	On	On	-	-	On	On

● LED on

○ LED off

AZM 161SK-12/03...G  
AZM 161CC-12/03...G

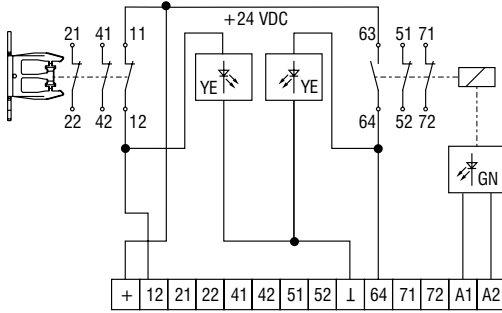

**Key**

- 12: guard closed
- + : +24 VDC
- ⊥ : 0 VDC
- 64: unlocked

System condition	Solenoid control		LED		Contacts							
	Power to unlock	green LED	Power to lock	green LED	yellow actuator	yellow magnet	21-22	41-42	11-12	63-64	51-52	71-72
Safety guard open	24V	●	0V	○	○	○	-	-	-	On	-	-
Guard closed, actuator inserted (not locked)	24V	●	0V	○	●	○	On	On	On	On	-	-
Guard closed, actuator inserted and locked	0V	○	24V	●	●	●	On	On	On	-	On	On

- LED on
- LED off

**5. Set-up and maintenance**

**5.1 Functional testing**

The safety function of the safety components must be tested. The following conditions must be previously checked and met:

1. Fitting of the solenoid interlock and the actuator
2. Check the integrity of the cable entry and connections
3. Check the switch enclosure for damage

**5.2 Maintenance**

A regular visual inspection and functional test, including the following steps, is recommended:

1. Check for tight installation of the actuator and the switch
2. Remove particles of dust and soiling
3. Check cable entry and connections



Adequate measures must be taken to ensure protection against tampering either to prevent tampering of the safety guard, for instance by means of replacement actuators.

**Damaged or defective components must be replaced.**

**6. Disassembly and disposal**

**6.1 Disassembly**

The safety switchgear must be disassembled in a de-energised condition only.

**6.2 Disposal**

The safety switchgear must be disposed of in an appropriate manner in accordance with the national prescriptions and legislations.

7. EU Declaration of conformity

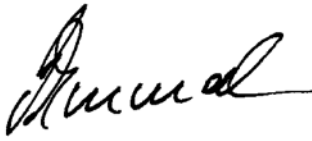
EU Declaration of conformity			
Translation of the original Declaration of Conformity	K.A. Schmersal GmbH & Co. KG Möddinghofe 30 42279 Wuppertal Germany Internet: www.schmersal.com		
We hereby certify that the hereafter described components both in their basic design and construction conform to the applicable European Directives.			
<b>Name of the component:</b>	AZM 161		
<b>Type:</b>	See ordering code		
<b>Description of the component:</b>	Interlocking device with electromagnetic interlock for safety functions		
<b>Relevant Directives:</b>		Valid up to	Valid as of
		April 19, 2016	April 20, 2016
	Machinery Directive	2006/42/EC	2006/42/EC
	EMC-Directive	2004/108/EC	2014/30/EU
	RoHS-Directive	2014/65/EU	2014/65/EU
<b>Applied standards:</b>	DIN EN 60947-5-1: 2010 DIN EN ISO 14119: 2014		
<b>Person authorized for the compilation of the technical documentation:</b>	Oliver Wacker Möddinghofe 30 42279 Wuppertal		
<b>Place and date of issue:</b>	Wuppertal, February 1, 2016		
			
	Authorised signature <b>Philip Schmersal</b> Managing Director		

AZM 161-E-EN



The currently valid declaration of conformity can be downloaded from the internet at [www.schmersal.net](http://www.schmersal.net).



**K. A. Schmersal GmbH & Co. KG**  
Möddinghofe 30, D - 42279 Wuppertal  
Postfach 24 02 63, D - 42232 Wuppertal

Phone: +49 - (0)2 02 - 64 74 - 0  
Telefax: +49 - (0)2 02 - 64 74 - 1 00  
E-Mail: [info@schmersal.com](mailto:info@schmersal.com)  
Internet: <http://www.schmersal.com>