



EN Operating instructions.pages 1 to 8
Translation of the original operating instructions

Content

1 About this document

1.1 Function 1

1.2 Target group: authorised qualified personnel. 1

1.3 Explanation of the symbols used 1

1.4 Appropriate use 1

1.5 General safety instructions 1

1.6 Warning about misuse 1

1.7 Exclusion of liability 2

2 Product description

2.1 Ordering code 2

2.2 Special versions. 2

2.3 Destination and use 2

2.4 Technical data 3

2.5 Safety classification 3

3 Mounting

3.1 General mounting instructions 3

3.2 Dimensions 4

4 Electrical connection

4.1 General information for electrical connection. 5

4.2 Contact variants. 6

5 Set-up and maintenance

5.1 Functional testing. 7

5.2 Maintenance 7

6 Disassembly and disposal

6.1 Disassembly. 7

6.2 Disposal. 7

7 Appendix

7.1 EC Declaration of conformity 8

1. About this document

1.1 Function

This operating instructions manual provides all the information you need for the mounting, set-up and commissioning to ensure the safe operation and disassembly of the safety switchgear. The operating instructions must be available in a legible condition and a complete version in the vicinity of the device.

1.2 Target group: authorised qualified personnel

All operations described in this operating instructions manual must be carried out by trained specialist personnel, authorised by the plant operator only.

Please make sure that you have read and understood these operating instructions and that you know all applicable legislations regarding occupational safety and accident prevention prior to installation and putting the component into operation.

The machine builder must carefully select the harmonised standards to be complied with as well as other technical specifications for the selection, mounting and integration of the components.

1.3 Explanation of the symbols used



Information, hint, note:

This symbol is used for identifying useful additional information.



Caution: Failure to comply with this warning notice could lead to failures or malfunctions.

Warning: Failure to comply with this warning notice could lead to physical injury and/or damage to the machine.

1.4 Appropriate use

The products described in these operating instructions are developed to execute safety-related functions as part of an entire plant or machine. It is the responsibility of the manufacturer of a machine or plant to ensure the correct functionality of the entire machine or plant.

The safety switchgear must be exclusively used in accordance with the versions listed below or for the applications authorised by the manufacturer. Detailed information regarding the range of applications can be found in the chapter "Product description".

1.5 General safety instructions

The user must observe the safety instructions in this operating instructions manual, the country-specific installation standards as well as all prevailing safety regulations and accident prevention rules.



Further technical information can be found in the Schmersal catalogues or in the online catalogue on the Internet: www.schmersal.net.

The information contained in this operating instructions manual is provided without liability and is subject to technical modifications.

There are no residual risks, provided that the safety instructions as well as the instructions regarding mounting, commissioning, operation and maintenance are observed.

1.6 Warning about misuse



In case of improper use or manipulation of the safety switchgear, personal hazards or damages to machinery or plant components cannot be excluded when safety switchgear is used. The relevant requirements of the standard ISO 14119 must be observed.

1.7 Exclusion of liability

We shall accept no liability for damages and malfunctions resulting from defective mounting or failure to comply with this operating instructions manual. The manufacturer shall accept no liability for damages resulting from the use of unauthorised spare parts or accessories.

For safety reasons, invasive work on the device as well as arbitrary repairs, conversions and modifications to the device are strictly forbidden; the manufacturer shall accept no liability for damages resulting from such invasive work, arbitrary repairs, conversions and/or modifications to the device.

2. Product description

2.1 Ordering code

This operating instructions manual applies to the following types:

AZM 170^①-^②Z^③I^④-^⑤-^⑥-^⑦ ^⑧

No.	Option	Description
①	SK	Cut clamps Screw connection
②	11	1 NO / 1 NC
	02	2 NC
③	R	Latching force 5 N Latching force 30 N
④	A	Power to unlock Power to lock
⑤	ST	Cable gland M12 x 1 connector
	ST-2431	M12 connector, separated magnet monitoring
⑥	B1	Actuator B1 included
	B5	Actuator B5 included
	B6L	Actuator B6L included
	B6R	Actuator B6R included
⑦	2197	Manual release Manual release from side (default in the connector and power-to-unlock version)
	1637	Gold-plated contacts
⑧	24 VAC / DC	U _s 24 VAC / DC
	110 VAC	U _s 110 VAC
	230 VAC	U _s 230 VAC

AZM 170^①-^②Z^③I^④^⑤-^⑥-^⑦ 24 VAC / DC

No.	Option	Description
①	SK	Screw connection
	ST	M12 x 1 connector
②	12 / 11	1 NO 2 NC / 1 NO 1 NC
	12 / 02	1 NO 2 NC / 2 NC
	12 / 00	1 NO 2 NC / -
	11 / 11	1 NO 1 NC / 1 NO 1 NC
	11 / 02	1 NO 1 NC / 2 NC
	02 / 10	2 NC / 1 NO
	02 / 01	2 NC / 1 NC
③	R	Latching force 5 N Latching force 30 N
④	A	Power to unlock Power to lock
⑤	B1	Actuator B1 included
	B5	Actuator B5 included
	B6L	Actuator B6L included
	B6R	Actuator B6R included
⑥	1637	Gold-plated contacts
⑦	2197	Manual release for Power to unlock



Only if the information described in this operating instructions manual are realised correctly, the safety function and therefore the compliance with the Machinery Directive is maintained.

2.2 Special versions

For special versions, which are not listed in the order code below 2.1, these specifications apply accordingly, provided that they correspond to the standard version.

2.3 Destination and use

The solenoid interlock has been designed to prevent in conjunction with the control part of a machine, movable safety guards from being opened before hazardous conditions have been eliminated. The AZM 170 I solenoid interlocks with individual coding offer a higher protection against tampering.



Interlocks with the power to lock principle may only be used in special cases after a thorough evaluation of the accident risk, since the guarding device can immediately be opened on failure of the electrical power supply or when the main switch is opened.



The safety switchgear units are classified as type 2 interlocking devices in accordance with ISO 14119 and are rated as highly coded.

Manual release

A manual release is available as a mounting tool and in the event of a power failure in case the power to unlock principle is used. If the triangular key is turned 180°, the locking bolt is pulled into the unlocking position. Please ensure that jamming by external influence on the actuator is avoided. The normal locking function is only restored after the triangular key has been returned to its original position. After being put into operation, the manual release must be secured by installing the sealing plug, which is included in delivery.

Manual release

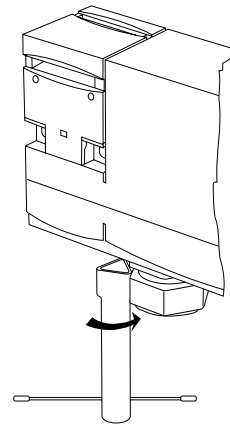

Manual release from side

Ordering suffix -2197 or ST

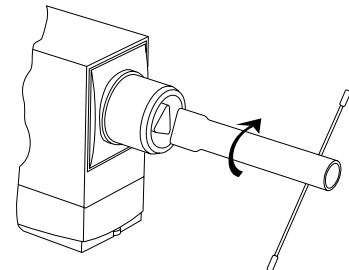

Triangular key TK-M5 (101100887) available as accessory.

Emergency exit

Fitting and actuation only from within the hazardous area.

To activate the emergency exit, turn the red lever in the direction of the arrow to the end stop. Please ensure that jamming by external influence on the actuator is avoided.



The user must evaluate and design the safety chain in accordance with the relevant standards and the required safety level.



The entire concept of the control system, in which the safety component is integrated, must be validated to the relevant standards.

2.4 Technical data

Standards:	IEC 60947-5-1, ISO 14119, BG-GS-ET-19
Enclosure:	glass-fibre reinforced thermo-plastic, self-extinguishing
Actuator and locking bolt:	stainless steel 1.4301
Contact material:	Silver
Holding force F:	1000 N
Latching force:	5 N
- Ordering suffix R:	30 N
Coding level according to ISO 14119:	high
Protection class:	IP67
Contact type:	change-over contact with double break, type Zb or 2 NC contacts, with galvanically separated contact bridges
Switching system:	⊖ IEC 60947-5-1; slow action, NC contact with positive break
Cable entry:	M20 x 1.5
Connection:	Cut clamps, screw terminals or M12 connector
Cable type:	flexible
Cable section:	
- IDC method of termination (cut clamps):	0.75...1.0 mm ²
- Screw terminals:	0.25...1.5 mm ² (incl. insulated conductor ferrules)
Rated impulse withstand voltage U _{imp} :	4 kV
- Connector:	0.8 kV
Rated insulation voltage U _i :	250 V
- Connector:	60 V
Thermal test current I _{the} :	6 A
- Connector:	2 A
Utilisation category:	DC 13
- AZM 170-...-11 and AZM 170-...-02	AC-15, DC-13
- Connector:	DC-13
Rated operating current/voltage I _e /U _e :	4 A / 24 VDC; 4 A / 230 VAC; 2 A / 24 VDC
- Connector:	2 A / 24 VDC
Required short-circuit current:	1000 A
Max. fuse rating:	6 A gG D-fuse
Connector:	2 A gG D-fuse
Positive break travel:	11 mm
Positive break force:	8.5 N for each NC contact fitted
Magnet:	100% ED
Rated control voltage U _s :	24 VAC / DC; 110 VAC 50 / 60 Hz; 230 VAC 50 / 60 Hz
Power consumption:	max. 12 W
Ambient temperature:	-25 °C ... +60 °C
Mechanical life:	> 1 million operations
Actuating speed:	max. 2 m/s
Actuating frequency:	max. 1000 operations/h

2.5 Safety classification

Standards:	ISO 13849-1
Envisaged structure:	
- Basically:	applicable up to Cat. 1 / PL c
- With 2-channel usage and fault exclusion mechanism*:	applicable up to Cat. 3 / PL d with suitable logic unit
B _{10d} NC contact:	2,000,000
B _{10d} NO contact at 10% ohmic contact load:	1,000,000
Service life:	20 years

* If a fault exclusion to the 1-channel mechanics is authorised.

$$MTTF_d = \frac{B_{10d}}{0,1 \times n_{op}} \quad n_{op} = \frac{d_{op} \times h_{op} \times 3600 \text{ s/h}}{t_{cycle}}$$

(Determined values can vary depending on the application-specific parameters h_{op}, d_{op} and t_{cycle} as well as the load.)

If multiple safety components are wired in series, the Performance Level to ISO 13849-1 will be reduced due to the restricted error detection under certain circumstances.

3. Mounting

3.1 General mounting instructions



On delivery, the actuator is in inserted condition. For power-to-unlock components, the actuator must be released by means of the manual release. If the triangular key is turned 180°, the locking bolt is pulled into the unlocking position. The normal locking function is only restored after the triangular key has been returned to its original position.

Two mounting holes are provided for fixing the enclosure. The solenoid interlock is double insulated. The use of an earth wire is not authorised. The solenoid interlock must not be used as an end stop. Any mounting position. The mounting position must be chosen so as to avoid the penetration of dirt in the used holes. The unused opening must be sealed by means of slot sealing plugs. Tightening force for the Torx T10 cover screws 0.7 ... 1 Nm.



The safety component and the actuator must be permanently fitted to the safety guards and protected against displacement by suitable measures (tamperproof screws, gluing, drilling, pinning).



Please observe the remarks of the standards ISO 12100, EN 953 and ISO 14119.

3.2 Dimensions

All measurements in mm.

AZM 170 with cut clamps and cable glands

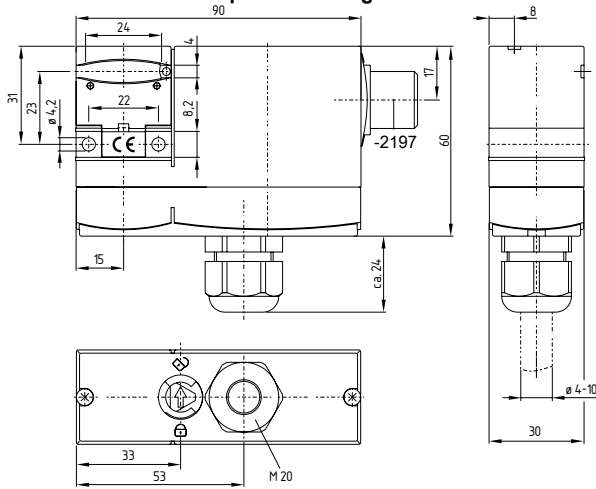

AZM 170SK with screw terminals and cable glands

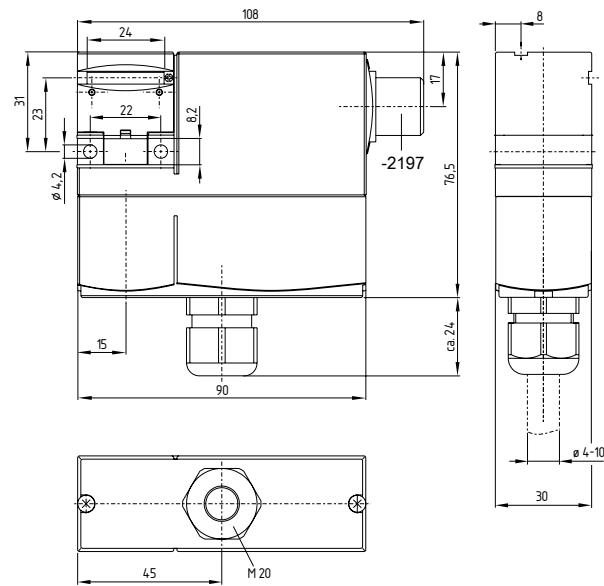

KEY: Manual release from side, ordering suffix -2197

AZM 170...-ST with connectors, 2 x 4 poles, A- or B-coding

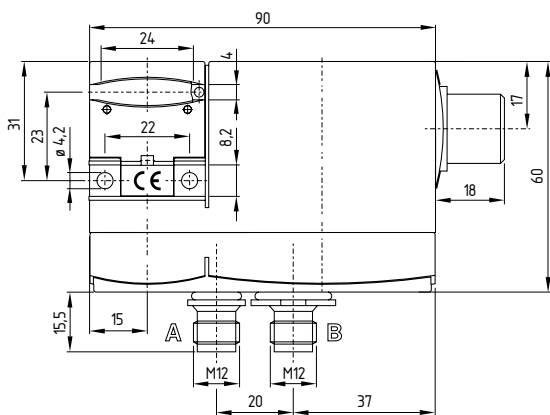

AZM 170ST with connectors, 1x 4 poles, 1 x 8 poles

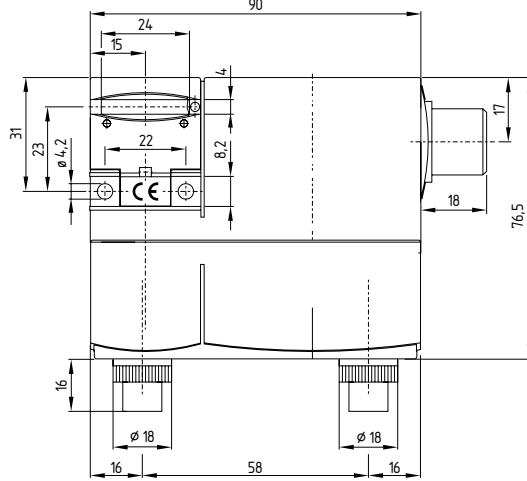

Actuator

Straight actuator B1

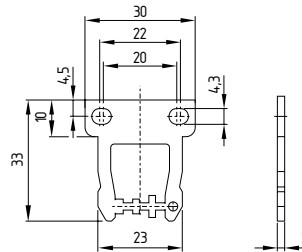

Angled actuator B5

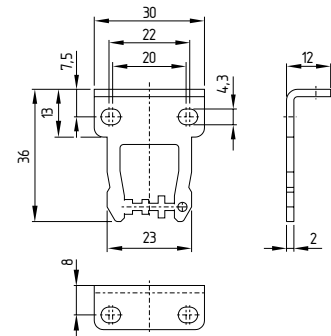

Flexible actuator B6L

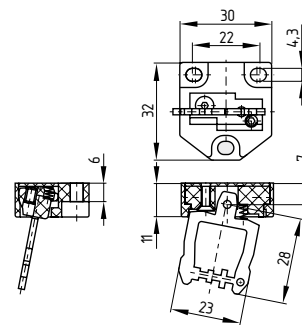

Flexible actuator B6R

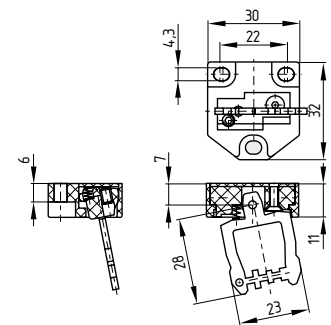

Mounting of the actuator



The marks on the used actuator opening of the solenoid interlock and on the actuator must be opposite.

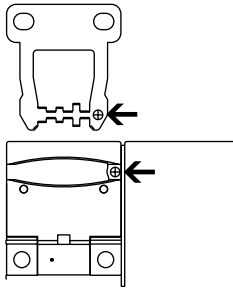

Please observe that, when fixing the switch e.g. by means of rivetting or welding, the insertion depth of the actuator is not modified. Different actuator forms are available. The actuators B1 and B5 are preferably used for sliding and removable safety guards. For hinged guards, the B6R and B6L actuators.

When the switch is fitted on a hinged safety guard, please ensure that the point of rotation is located within the range of the upper surface of the safety switch, in which the actuator hook is inserted (refer to table).

Actuating radii					
		R_{min} [mm]	d [mm]	R_{min} [mm]	d [mm]
	B6L	50	11	50	11
	B6R	50	11	50	11
	B1	-	-	-	-
	B5	-	-	-	-

Key

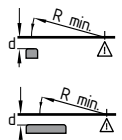

Actuating radius over the small edge of the actuator

Actuating radius over the wide edge of the actuator

The axis of the hinge must be d mm above and in a parallel plane to the top surface of the safety switch. The basis setting provides a minimum radius of Rmin.

Actuator B6L / B6R

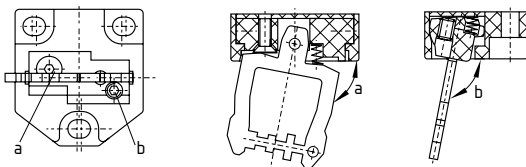

The B6L or B6R actuators are set to the smallest radius in factory. To increase the radius, the setting screws a + b must be turned by means of a hexagonal key A/F 2.5 mm.

4. Electrical connection

4.1 General information for electrical connection



The electrical connection may only be carried out by authorised personnel in a de-energised condition.



If the risk analysis indicates the use of a monitored interlock they are to be connected in the safety circuit with the contacts indicated with the symbol

For the cable entry, suitable cable glands with an appropriate degree of protection must be used.

Cut clamp terminals

The IDC method of termination (cut clamp technology) enables connecting flexible wires with cable section 0.75 - 1 mm² without using conductor ferrules. To this effect, strip the wire according to the drawing (refer to the wiring example) and insert it into the cable gland, close the cable gland, push the conductors in the groove of the cover (refer to wiring example) and screw the cover back. Observe that the individual conductors remain in position to avoid jamming.

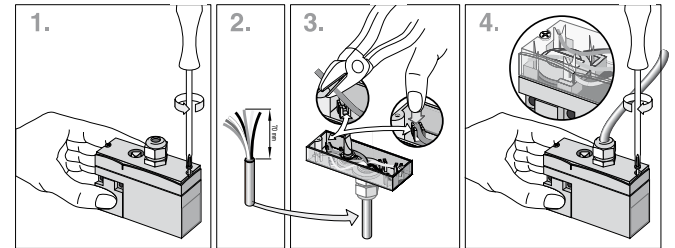

Screw terminals (SK version)

Unscrew the cover of the enclosure. Connect the cables to the terminal block. Use insulated conductor ferrules to that effect. Screw the cover back on the enclosure.

4.2 Contact variants

Contacts shown in a de-energised condition and with the actuator inserted.

AZM 170 I with cut clamps and screw terminals

Power to unlock

1 NO 1 NC
(ordering suffix -11)

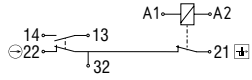

2 NC
(ordering suffix -02)

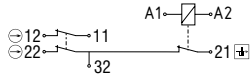

1 NO 2 NC / -
(ordering suffix -12/00)

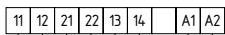
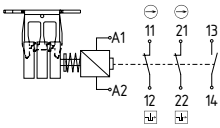

2 NC / 1 NC
(ordering suffix -02/01)

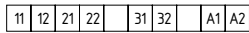
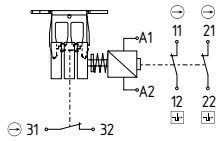

2 NC / 1 NO
(ordering suffix -02/10)

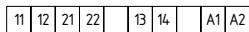
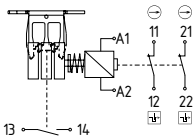

1 NO 1 NC / 1 NO 1 NC
(ordering suffix -11/11)

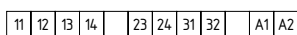
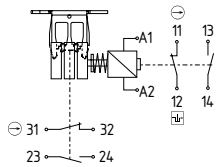

1 NO 1 NC / 2 NC
(ordering suffix -11/02)

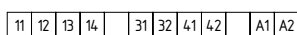
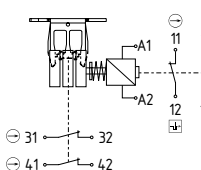

Power to lock

1 NO 1 NC
(ordering suffix -11)

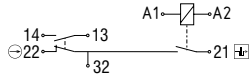

2 NC
(ordering suffix -02)

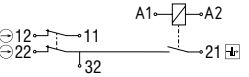

1 NO 2 NC / -
(ordering suffix -12/00)

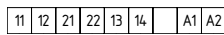
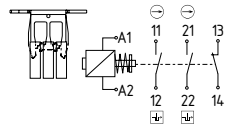

2 NC / 1 NC
(ordering suffix -02/01)

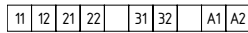
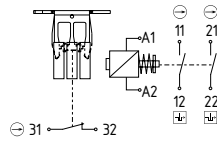

2 NC / 1 NO
(ordering suffix -02/10)

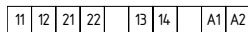
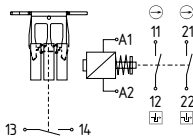

1 NO 1 NC / 1 NO 1 NC
(ordering suffix -11/11)

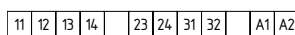
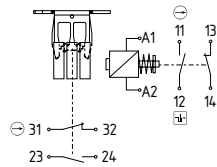

1 NO 1 NC / 2 NC
(ordering suffix -11/02)

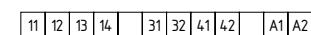
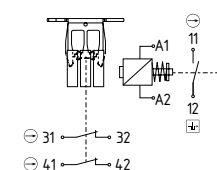

AZM 170 I with connector

Power to unlock

1 NO 1 NC
(ordering suffix -11)

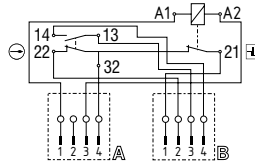

2 NC
(ordering suffix -02)

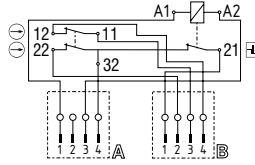

1 NO 2 NC / 2 NC
(ordering suffix -12/02)

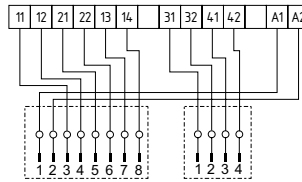
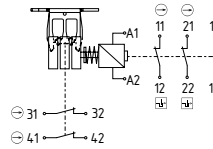

1 NO 2 NC / 1 NO 1 NC
(ordering suffix -12/11)

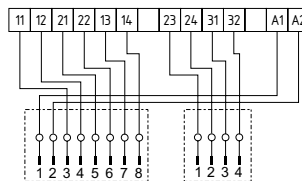
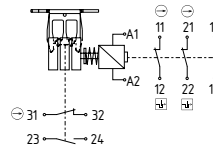

1 NO 1 NC / 1 NO 1 NC
(ordering suffix -11/11)

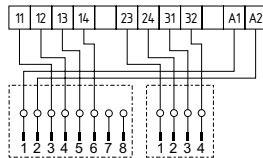
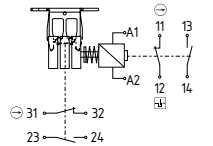

Power to lock

1 NO 1 NC
(ordering suffix -11)

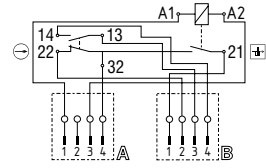

2 NC
(ordering suffix -02)

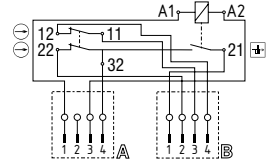

1 NO 2 NC / 2 NC
(ordering suffix -12/02)

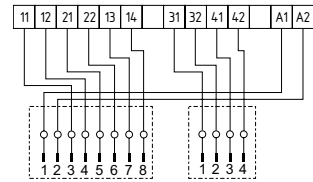
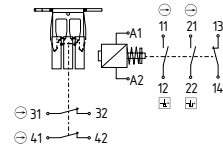

1 NO 2 NC / 1 NO 1 NC
(ordering suffix -12/11)

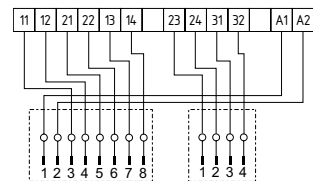
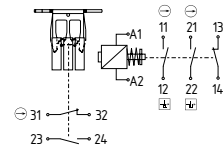

1 NO 1 NC / 1 NO 1 NC
(ordering suffix -11/11)

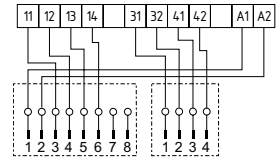
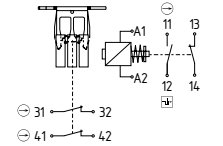

AZM 170 I with connector

Power to unlock

1 NO 1 NC / 2 NC
(ordering suffix -11/02)

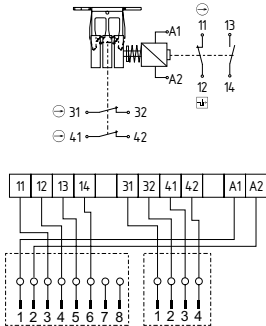

Power to lock

1 NO 1 NC / 2 NC
(ordering suffix -11/02)

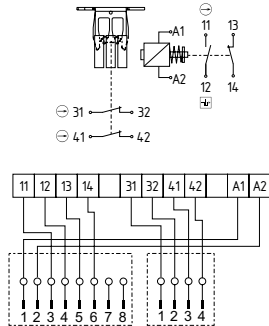

Key

⊖ Positive break NC contact

Ⓜ Monitoring the interlock according to ISO 14119

5. Set-up and maintenance

5.1 Functional testing

The safety function of the safety components must be tested. The following conditions must be previously checked and met:

1. Fitting of the solenoid interlock and the actuator
2. Check the integrity of the cable entry and connections
3. Check the switch enclosure for damage

5.2 Maintenance

A regular visual inspection and functional test, including the following steps, is recommended:

1. Check for tight installation of the actuator and the switch
2. Remove particles of dust and soiling
3. Check cable entry and connections



Adequate measures must be taken to ensure protection against tampering either to prevent tampering of the safety guard, for instance by means of replacement actuators.

Damaged or defective components must be replaced.

6. Disassembly and disposal

6.1 Disassembly

The safety switchgear must be disassembled in a de-energised condition only.

6.2 Disposal

The safety switchgear must be disposed of in an appropriate manner in accordance with the national prescriptions and legislations.

7.1 EC Declaration of conformity

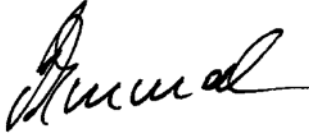
	
EC Declaration of conformity	
Translation of the original Declaration of Conformity	K.A. Schmersal GmbH & Co. KG Mödinghofe 30 42279 Wuppertal Germany Internet: www.schmersal.com
We hereby certify that the hereafter described safety components both in its basic design and construction conform to the applicable European Directives.	
Name of the safety component:	AZM 170 I
Description of the safety component:	Interlocking device with electromagnetic interlock for safety functions
Relevant EC-Directives:	2006/42/EC-EC-Machinery Directive 2004/108/EC EMC-Directive
Person authorised for the compilation of the technical documentation:	Oliver Wacker Mödinghofe 30 42279 Wuppertal
Place and date of issue:	Wuppertal, 27 October 2015
AZM170I-B-EN	
	Authorised signature Philip Schmersal Managing Director



The currently valid declaration of conformity can be downloaded from the internet at www.schmersal.net.



K.A. Schmersal GmbH & Co. KG
Mödinghofe 30, D - 42279 Wuppertal
Postfach 24 02 63, D - 42232 Wuppertal

Phone: +49 - (0)2 02 - 64 74 - 0
Telefax: +49 - (0)2 02 - 64 74 - 1 00
E-Mail: info@schmersal.com
Internet: <http://www.schmersal.com>