



EN Operating instructions. pages 1 to 10
Original

7 Set-up and maintenance
7.1 Functional testing7
7.2 Maintenance7

8 Disassembly and disposal
8.1 Disassembly7
8.2 Disposal.7

9 Appendix
9.1 Wiring examples8
9.2 Wiring configuration and connector accessories.9

10 EU Declaration of conformity

Content

1 About this document
1.1 Function.1
1.2 Target group: authorised qualified personnel1
1.3 Explanation of the symbols used.1
1.4 Appropriate use.1
1.5 General safety instructions1
1.6 Warning about misuse.2
1.7 Exclusion of liability.2

2 Product description
2.1 Ordering code2
2.2 Special versions2
2.3 Comprehensive quality insurance to 2006/42/EC2
2.4 Destination and use.2
2.5 Technical data2
2.6 Safety classification.3

3 Mounting
3.1 General mounting instructions.3
3.2 Manual release4
3.3 Dimensions4

4 Electrical connection
4.1 General information for electrical connection4

5 Operating principle and diagnostic functions
5.1 Magnet control.4
5.2 Mode of operation of the safety outputs4

6 Diagnostic functions
6.1 Diagnostic LED's5
6.2 Solenoid interlock with conventional diagnostic output5
6.3 Solenoid interlock with serial diagnostic function6

1. About this document

1.1 Function

This operating instructions manual provides all the information you need for the mounting, set-up and commissioning to ensure the safe operation and disassembly of the safety switchgear. The operating instructions must be available in a legible condition and a complete version in the vicinity of the device.

1.2 Target group: authorised qualified personnel

All operations described in this operating instructions manual must be carried out by trained specialist personnel, authorised by the plant operator only.

Please make sure that you have read and understood these operating instructions and that you know all applicable legislations regarding occupational safety and accident prevention prior to installation and putting the component into operation.

The machine builder must carefully select the harmonised standards to be complied with as well as other technical specifications for the selection, mounting and integration of the components.

1.3 Explanation of the symbols used



Information, hint, note:

This symbol is used for identifying useful additional information.



Caution: Failure to comply with this warning notice could lead to failures or malfunctions.

Warning: Failure to comply with this warning notice could lead to physical injury and/or damage to the machine.

1.4 Appropriate use

The products described in these operating instructions are developed to execute safety-related functions as part of an entire plant or machine. It is the responsibility of the manufacturer of a machine or plant to ensure the correct functionality of the entire machine or plant.

The safety switchgear must be exclusively used in accordance with the versions listed below or for the applications authorised by the manufacturer. Detailed information regarding the range of applications can be found in the chapter "Product description".

1.5 General safety instructions

The user must observe the safety instructions in this operating instructions manual, the country-specific installation standards as well as all prevailing safety regulations and accident prevention rules.



Further technical information can be found in the Schmersal catalogues or in the online catalogue on the Internet: www.schmersal.net.

The information contained in this operating instructions manual is provided without liability and is subject to technical modifications.

There are no residual risks, provided that the safety instructions as well as the instructions regarding mounting, commissioning, operation and maintenance are observed.

1.6 Warning about misuse



In case of improper use or manipulation of the safety switchgear, personal hazards or damages to machinery or plant components cannot be excluded when safety switchgear is used. The relevant requirements of the standard ISO 14119 must be observed.

1.7 Exclusion of liability

We shall accept no liability for damages and malfunctions resulting from defective mounting or failure to comply with this operating instructions manual. The manufacturer shall accept no liability for damages resulting from the use of unauthorised spare parts or accessories.

For safety reasons, invasive work on the device as well as arbitrary repairs, conversions and modifications to the device are strictly forbidden; the manufacturer shall accept no liability for damages resulting from such invasive work, arbitrary repairs, conversions and/or modifications to the device.

2. Product description

2.1 Ordering code

This operating instructions manual applies to the following types:

AZM 200 ① ②-T-③④

No.	Option	Description
①	B	Solenoid interlock monitored
	SK	Actuator monitored
②	CC	Screw connection
	ST1	Cage clamps
	ST2	Connector plug M23, (8+1)-pole
③	1P2P	Connector plug M12, 8-pole
	1P2PW	1 p-type diagnostic output and 2 p-type safety outputs
	SD2P	Similar to -1P2P, combined diagnostic signal guard door closed and solenoid interlock locked
④	A	Serial diagnostic output and 2 p-type safety outputs
		Power to unlock
		Power to lock



Only if the information described in this operating instructions manual are realised correctly, the safety function and therefore the compliance with the Machinery Directive is maintained.

2.2 Special versions

For special versions, which are not listed in the order code below 2.1, these specifications apply accordingly, provided that they correspond to the standard version.

2.3 Comprehensive quality insurance to 2006/42/EC

Schmersal is a certified company to appendix X of the Machinery Directive. As a result, Schmersal is entitled to autonomously conduct the conformity assessment procedure for the products listed in Appendix IV of the MD without involving a notified body. The prototype test certificates are available upon request or can be downloaded from the Internet at www.schmersal.com.

2.4 Destination and use

The AZM 200 with non-contact electronic safety sensors is designed for application in safety circuits and is used for monitoring the position of movable safety guards.

The safety function consists of safely switching off the safety outputs when the safety guard is unlocked or opened and maintaining the safe switched off condition of the safety outputs for as long as the safety guard is open.



For applications requiring a safe monitoring of the interlocking function, the AZM 200 ... variant must be selected. The AZM 200 B ... is a safety switch with additional interlocking function.



Interlocks with power to lock principle may only be used in special cases after a thorough evaluation of the accident risk, since the safety guard can be opened immediately on failure of the power supply or upon activation of the main switch.



The safety switchgears are classified according to ISO 14119 as type 4 interlocking devices.

Series-wiring

Series-wiring can be set up. The response and risk times are not altered by wiring in series. The number of components is only limited by the external cable protection according to the technical data and the line loss. Up to 31 components can be wired in series.

In devices with the serial diagnostics function (ordering suffix -SD), the serial diagnostics connections are wired in series and connected to a SD Gateway for evaluation purposes.

Wiring examples for series-wiring, refer to appendix



The user must evaluate and design the safety chain in accordance with the relevant standards and the required safety level. If multiple safety switchgears are involved in the same safety function, the PFH values of the individual components must be added.



The entire concept of the control system, in which the safety component is integrated, must be validated to the relevant standards.

2.5 Technical data

Standards:	IEC 60947-5-1, IEC 60947-5-3, ISO 14119, ISO 13849-1, IEC 61508, IEC 62061
Material of the enclosure:	glass-fibre reinforced thermoplastic, self-extinguishing
Mechanical life:	≥ 1 million operations
Holding force F:	2000 N (1000 N when used with the AZ/AZM 200-B30 actuator, for indoor use)
Coding levels according to ISO 14119:	low
Latching force:	30 N
Protection class:	IP67 to IEC 60529
Insulation protection class:	II,
Overvoltage category:	III
Degree of pollution:	3
Execution of the electrical connection:	screw terminals or cage clamp connection, M12 or M23 connector
Cable section:	min. 0.25 mm ² , max. 1.5 mm ² (including conductor ferrules)
Cable entry:	M20
Tightening torque for the cover screws:	0.7 ... 1 Nm (Torx T10)
Series-wiring:	up to 31 devices
Cable length:	max. 200 m (Cable length and cable section alter the voltage drop depending on the output current)

Ambient conditions:

Ambient temperature:	-25 °C ... +60 °C
Storage and transport temperature:	-25 °C ... +85 °C
Resistance to vibration:	10 ... 55 Hz, amplitude 1 mm
Resistance to shock:	30 g / 11 ms
Switching frequency:	1 Hz
Response time:	< 60 ms
Duration of risk:	< 120 ms
Time to readiness:	< 4000 ms
Max. actuating speed:	≤ 0.2 ms

Electrical data:

Rated operating voltage U_e :	24 VDC -15% / +10% (stabilised PELV)
Rated operating current I_e :	1.2 A
Required rated short-circuit current:	100 A
No-load current I_0 :	max. 0.5 A
Rated impulse withstand voltage U_{imp} :	0.8 kV
Rated insulation voltage U_i :	32 VDC
Device fuse rating:	
- Screw terminals or cage clamps:	≤ 4 A when used to UL 508;
- Connector plug M12 or M23:	≤ 2 A

Safety inputs X1 and X2:

Rated operating voltage U_{e3} :	-3 V ... 5 V (Low) 15 V ... 30 V (High)
------------------------------------	--

Rated operating current I_{e3} :	typically 2 mA at 24 V
------------------------------------	------------------------

Safety outputs Y1 and Y2:

	p-type, short-circuit proof
Rated operating voltage U_{e1} :	0 V ... 4 V under U_e
Rated operating current I_{e1} :	max. 0.25 A each
Utilisation category:	DC-13
Leakage current I_r :	≤ 0.5 mA

Diagnostic output OUT:

	short-circuit proof, p-type
Rated operating voltage U_{e2} :	0 V ... 4 V under U_e
Operating current I_{e2} :	max. 0,05 A
Utilisation category:	DC-13: 24 V / 0.05 A
Wiring capacitance for serial diagnostics:	max. 50 nF

Magnet control IN:

Rated operating voltage $U_{e4/Low}$:	-3 V ... 5 V
Rated operating voltage $U_{e4/High}$:	15 V ... 30 V
Rated operating current I_{e4} :	typically 10 mA at 24 V, dynamically 20 mA

Magnet:	100% ED
---------	---------

LED switching conditions display:

green LED:	Supply voltage
yellow LED:	Operating condition
red LED:	Error / functional defect



Use isolated power supply only.
For use in NFPA 79 Applications only.
Adapters providing field wiring means are available from the manufacturer. Refer to manufacturers information.

2.6 Safety classification

- of the interlocking function:

Standards:	ISO 13849-1, IEC 61508, IEC 62061
PL:	e
Control Category:	4
PFH:	$4.0 \times 10^{-9} / h$
PFD:	1.0×10^{-4}
SIL:	suitable for SIL 3 applications
Service life:	20 years

- of the guard locking function:

Standards:	ISO 13849-1, IEC 61508, IEC 62061
PL:	d
Control Category:	2
PFH:	$2.5 \times 10^{-9} / h$
PFD:	2.2×10^{-4}
SIL:	suitable for SIL 2 applications
Service life:	20 years



The safety consideration of the guard locking function only applies for standard devices with monitored solenoid interlock AZM 200...-1P2P(W)... (see Ordering code).



The actuation of the interlock must be compared with the external OSSD enabler. If a shut-down now occurs due to an unintentional unlocking this is detected by an external diagnostic.



If for a certain application the quiescent current version of a solenoid interlock cannot be used, then for this exception an interlock with power to lock can be used if additional safety measure need to be realised that have an equivalent safety level.



The safety analysis of the guard locking function refers to the component solenoid interlock AZM as part of the complete system.
On the customer side further measures such as safe actuation and safe cable installation to prevent faults are to be implemented.
In the event of a fault resulting in the unlocking of the guard locking, this is detected by the solenoid interlock and the safety gates Y1/Y2 switch off. When such a fault occurs the protection equipment may open immediately, just once, before the safe condition of the machine is reached. The system reaction of category 2 allows that a fault can occur between tests causing the loss of the safety function which is detected by the test.

3. Mounting

3.1 General mounting instructions

For fitting the AZM 200 solenoid interlock, two mounting holes for M6 screws with washers (washers included in delivery) are provided. The solenoid interlock must not be used as an end stop. Any mounting position. The mounting position however must be chosen so that the ingress of dirt and soiling in the used opening is avoided. The unused actuator opening must be sealed by means of the dust-proof flap (included in delivery). Minimum distance between two solenoid interlocks: 100 mm.



The safety component and the actuator must be permanently fitted to the safety guards and protected against displacement by suitable measures (tamperproof screws, gluing, drilling, pinning).



Please observe the remarks of the standards ISO 12100, EN 953 and ISO 14119.

Mounting of the actuators

Refer to the mounting instructions manual for the corresponding actuator.

3.2 Manual release

For the machine set-up, the solenoid interlock can be unlocked in a de-energised condition. After opening of the plastic flap "A" (refer to image "Dimensions"), the triangular key must be turned clockwise to bring the blocking bolt in unlocking condition. The normal locking function is only restored after the triangular key has been returned to its original position. Caution: do not turn beyond the latching point! After being put into operation, the manual release must be secured by closing the plastic flap "A" and affixing the seal, which is included in delivery.

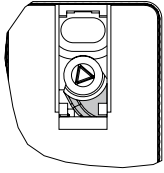

Component ready for operation

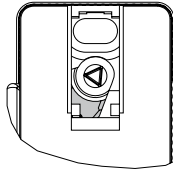

Component not ready for operation

3.3 Dimensions

All measurements in mm.

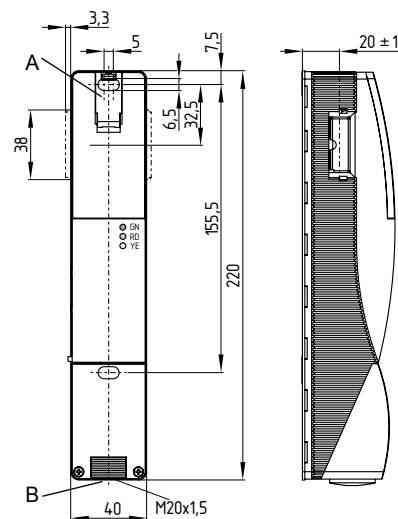

Key
A: Manual release
B: Cable entry

4. Electrical connection

4.1 General information for electrical connection



The electrical connection may only be carried out by authorised personnel in a de-energised condition.

The power supply for the solenoid interlock must provide protection against permanent overvoltage. To that effect, stabilised PELV supply units must be used. The safety outputs can be directly integrated in the safety circuit of the control system. For applications up to PL e / control category 4 to ISO 13849-1, the safety outputs of the solenoid interlock(s) (max. 31 components (wired in series)) must be connected to a safety-monitoring module of the same control category (refer to wiring examples). Inductive loads (e.g. contactors, relays, etc.) are to be provided with suitable interference suppression circuitry.

Requirements for the connected safety-monitoring module:

- Dual-channel safety input, suitable for 2 p-type semi-conductor outputs



Configuration of the safety controller

If the safety sensor is connected to electronic safety-monitoring modules, we recommend that you set a discrepancy time of 100 ms. The safety inputs of the safety-monitoring module must be able to blank a test impulse of approx. 1 ms. The safety-monitoring module does not need to have a cross-wire short monitoring function, if necessary, the cross-wire short monitoring function must be disabled.



Information for the selection of suitable safety-monitoring modules can be found in the Schmersal catalogues or in the online catalogue on the Internet: www.schmersal.net.

If the safety component is wired to relays or to non-safety relevant control components, a new risk analysis must be carried out.

Cable

The cable entry is realised by a metric M20 gland. This gland must be measured by the user so that it is suitable for the cable used. A cable gland with strain relief and suitable IP protection class must be used.

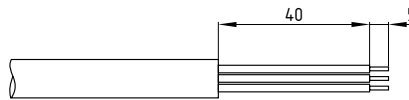

The maximum cable length is 200 m (for ST2 M12 connectors approx. 20 m depending on the cable section used for an operating current of 0.5 A). The maximum cable section is 1.5 mm², incl. conductor ferrules. Prior to the connection, the cable must be stripped by 40+5 mm and insulated by 5 mm. The fitted 24V, X1, X2 bridge is included in the delivery of ...-1P2P and ...-SD2P.

5. Operating principle and diagnostic functions

5.1 Magnet control

In the power to unlock version of the AZM 200, the solenoid interlock is unlocked when the IN signal (= 24V) is set. In the power to lock version of the AZM 200, the solenoid interlock is locked when the IN signal (= 24 V) is set.

5.2 Mode of operation of the safety outputs

In the standard AZM 200 variant, the unlocking of the solenoid interlock causes the safety outputs to be disabled. The unlocked safety guard can be relocked as long as the actuator is inserted in the AZM 200 solenoid interlock; in that case, the safety outputs are re-enabled.

The safety guard must not be opened.

In the B-variant AZM 200 B..., the opening of the safety guard causes the safety outputs to be disabled.

6. Diagnostic functions

6.1 Diagnostic LED's

The solenoid interlock signals the operational state as well as errors through three coloured LED's installed on the front side of the device.

- green** Supply voltage on
- red** Fault (s. Table: flash codes of the red diagnostic LED)
- yellow** Operating condition

6.2 Solenoid interlock with conventional diagnostic output

The short-circuit proof diagnostic output can be used for central visualisation or control functions, e.g. in a PLC. The diagnostic output is not a safety-related output!

Depending on the chosen variant, the following diagnostic signals are transmitted:

1P2P variant:

OUT guard door closed

1P2PW variant:

OUT combined diagnostic signal: guard door closed and solenoid interlock locked

Error

Errors, which no longer guarantee the function of the AZM 200 solenoid interlock (internal errors) cause the safety outputs to be disabled within the risk time. Any error that does not immediately affect the safe functionality of the AZM 200 solenoid interlock (e.g. the ambient temperature too high, interference potential at a safety output, cross-wire short) will lead to a delayed shut-down (refer to table 2).

After fault rectification, the sensor can be reset by opening and relocking the relevant guard door. The safety outputs enable and allow a restart. An interlocking chain must be permanently "locked" to enable the reactivation.



If more than one fault is detected at the safety outputs, the AZM 200 will be electronically locked and a normal fault reset will no longer be possible. To reset this type of interlocking, the AZM 200, must be isolated from the power supply after elimination of the error causes.

Error warning

A fault has occurred, which causes the safety outputs to be disabled after 30 minutes. The safety outputs initially remain enabled. This enables the shutdown of the process in a controlled manner. An error warning is deleted in the slave when the error cause is eliminated.

Behaviour of the diagnostic outputs of the W variant (Example: power to unlock version)

Input signal magnet control

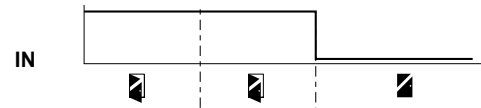

Normal sequence, door was locked

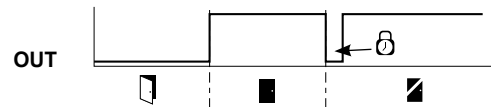

Door could not be locked or fault

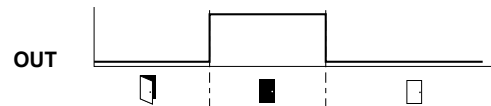

Key

- Safety guard open
- Safety guard closed
- Unlock safety guard
- Safety guard locked
- Delay time
- Guard not locked or fault

Evaluation of the diagnostic outputs of the W variant

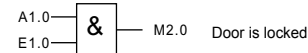
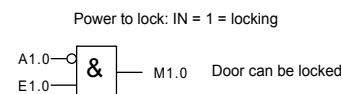
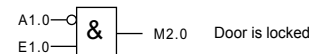
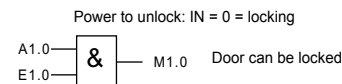
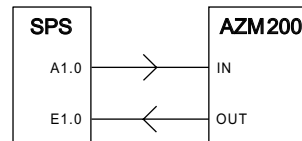

Table 1: the diagnostic function of the AZM 200 solenoid interlock

System condition	Solenoid control IN		LED			Safety outputs Y1, Y2		Diagnostic outputs OUT	
	Power to unlock	Power to lock	green	red	yellow	AZM 200	AZM 200 B	-1P2P	-1P2PW
Safety guard open	24 V (0 V)	0 V (24 V)	On	Off	Off	0 V	0 V	0 V	0 V
Door closed, actuator not inserted	24 V	0 V	On	Off	Off	0 V	0 V	0 V	0 V
Door closed, actuator inserted, not locked	24 V	0 V	On	Off	Flashes	0 V	24 V	24 V	24 V
Door closed, actuator inserted, interlocking blocked	0 V	24 V	On	Off	Flashes	0 V	24 V	24 V	0 V
Guard closed, actuator inserted and locked	0 V	24 V	On	Off	On	24 V	24 V	24 V	24 V
Error warning¹⁾ solenoid interlock locked	0 V	24 V	On	Flashes ²⁾	On	24 V ¹⁾	24 V ¹⁾	0 V	0 V
Error	0 V (24 V)	24 V (0 V)	On	Flashes ²⁾	Off	0 V	0 V	0 V	0 V

1) after 30 min: disabling due to fault
2) refer to flash code

Table 2: flash codes red LED

Flash codes (red)	Designation	Autonomous switch-off after	Error cause
1 flash pulse	Error (warning) at output Y1	30 min	Fault in output test or voltage at output Y1, although the output is disabled.
2 flash pulses	Error (warning) at output Y2	30 min	Fault in output test or voltage at output Y2, although the output is disabled.
3 flash pulses	Error (warning) cross-wire short	30 min	Cross-wire short between the output cables or fault at both outputs
4 flash pulses	Error (warning) temperature too high	30 min	The temperature measurement reveals an internal temperature that is too high
5 flash pulses	Error target	0 min	incorrect or defective actuator
6 flash pulses	Error target combination	0 min	An invalid combination of actuators was detected (blocking bolt detection or tamper attempt).
Continuous red signal	Internal error	0 min	

6.3 Solenoid interlock with serial diagnostic function

Solenoid interlocks with serial diagnostic cable have a serial input and output cable instead of the conventional diagnostic output. If solenoid interlocks are wired in series, the diagnostic data is transmitted through the series-wiring of the inputs and outputs.

Max. 31 solenoid interlocks can be wired in series. For the evaluation of the serial diagnostics line either the PROFIBUS-Gateway SD-I-DP-V0-2 or the Universal-Gateway SD-I-U-... are used. This serial diagnostic interface is integrated as a slave in an existing field bus system. In this way, the diagnostic signals can be evaluated by means of a PLC.

The response data and the diagnostic data are automatically and permanently written in an input byte of the PLC for each solenoid interlock in the series-wired chain. The request data for each solenoid interlock is transmitted to the component through an output byte of the PLC. In case of a communication error between the field bus gateway and the solenoid interlock, the switching condition of the solenoid interlock is maintained.

Error

A fault has occurred, which causes the safety outputs to be disabled. The fault is reset, when the cause is eliminated and bit 7 of the request byte changes from 1 to 0 or the safety guard is opened. Faults at the safety outputs are only deleted upon the next release, as the fault rectification cannot be detected sooner.



If more than one fault is detected at the safety outputs, the AZM 200 will be electronically locked and a normal fault reset will no longer be possible. To reset this type of interlocking, the AZM 200, must be isolated from the power supply after elimination of the error causes.

Error warning

A fault has occurred, which causes the safety outputs to be disabled after 30 minutes. The safety outputs initially remain enabled. This enables the shutdown of the process in a controlled manner. An error warning is deleted when the cause of error is eliminated.

Diagnostic error (warning)

If an error (warning) is signalled in the response byte, detailed fault information can be read out.

Accessories for the series-wiring

To provide for a comfortable wiring and series-wiring of SD components, the connectors and the SD-2V-F-SK SD junction boxes (variant for the field in closed enclosure) and SD-2V-S-SK (variant for DIN rail mounting in the control cabinet) are available.



When wiring SD devices, please observe the voltage drop on the cables and the current carrying capacity of the individual components.

Table 3: I/O data and diagnostic data

Bit n°	Request byte	Response byte	Diagnostic error warning	Diagnostic error
Bit 0:	Magnet in, irrespective of power to lock or power to unlock principle	Safety output activated	Error output Y1	Error output Y1
Bit 1:	---	Actuator detected	Error output Y2	Error output Y2
Bit 2:	---	Actuator detected and locked	Cross-wire short	Cross-wire short
Bit 3:	---	---	Temperature too high	Temperature too high
Bit 4:	---	Input condition X1 and X2	---	incorrect or defective actuator
Bit 5:	---	Guard door detected	Internal device error	Internal device error
Bit 6:	---	Error warning ¹⁾	Communication error between the field bus Gateway and the safety switchgear	---
Bit 7:	Error reset	Error (enabling path switched off)	Operating voltage too low	---

¹⁾ after 30 min -> fault

The described condition is reached, when Bit = 1

7. Set-up and maintenance

7.1 Functional testing

The safety function of the safety components must be tested. The following conditions must be previously checked and met:

1. Fitting of the solenoid interlock and the actuator
2. Check the integrity of the cable entry and connections
3. Check the switch enclosure for damage

7.2 Maintenance

We recommend a regular visual inspection and functional test, including the following steps:

1. Check for tight installation of the actuator and the switch
2. Remove particles of dust and soiling
3. Check cable entry and connections



Adequate measures must be taken to ensure protection against tampering either to prevent tampering of the safety guard, for instance by means of replacement actuators.

Damaged or defective components must be replaced.

8. Disassembly and disposal

8.1 Disassembly

The safety switchgear must be disassembled in a de-energised condition only.

8.2 Disposal

The safety switchgear must be disposed of in an appropriate manner in accordance with the national prescriptions and legislations.

9. Appendix

9.1 Wiring examples

The application examples shown are suggestions. They however do not release the user from carefully checking whether the switchgear and its set-up are suitable for the individual application.

Wiring example 1: Series-wiring of the AZM 200 with conventional diagnostic output

The series-wiring of multiple AZM 200 solenoid interlocks is realised by wiring in the control cabinet or in on-site junction boxes. In the example, 2 AZM 200 solenoid interlocks (max. 31 components) are wired in series. The diagnostic output ("OUT") and the magnet control ("IN") are separately wired to a conventional PLC for evaluation or control. The maximum cable length of the safety circuits must not exceed 200 m. In the series-wiring, the 24V-X1-X2 bridge must be removed from all components up to the last component. The voltage is supplied at both safety inputs of the terminal safety component of the chain (considered from the safety-monitoring module). The safety outputs of the first safety component are wired to the safety-monitoring module.

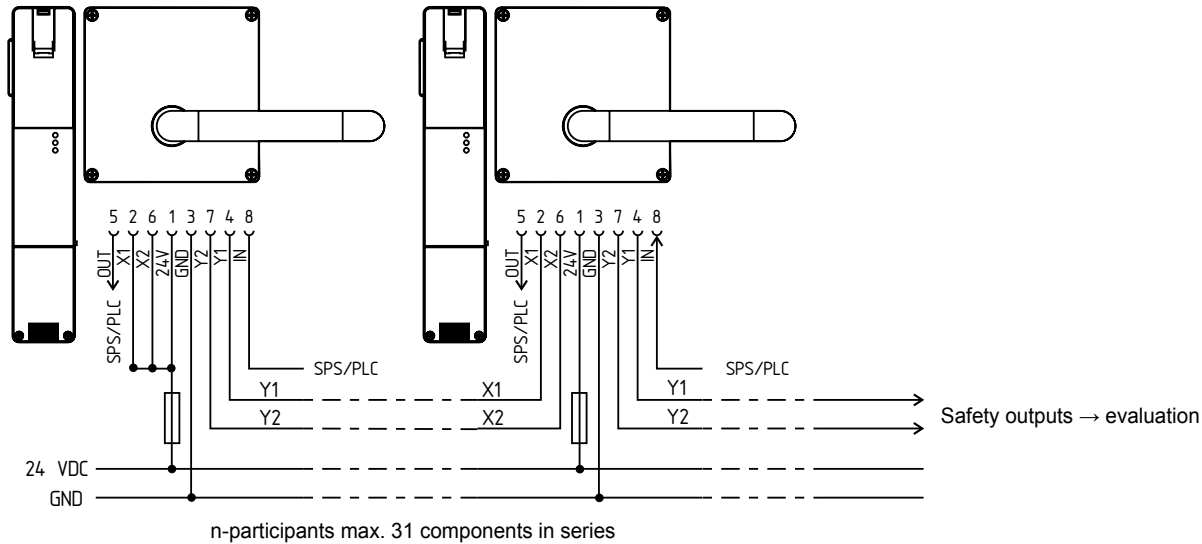

Wiring example 2: Series-wiring of the AZM 200 with serial diagnostic function

The safety outputs of the first safety component are wired to the safety-monitoring module. The serial Diagnostic Gateway is connected to the serial diagnostic input of the first safety component.

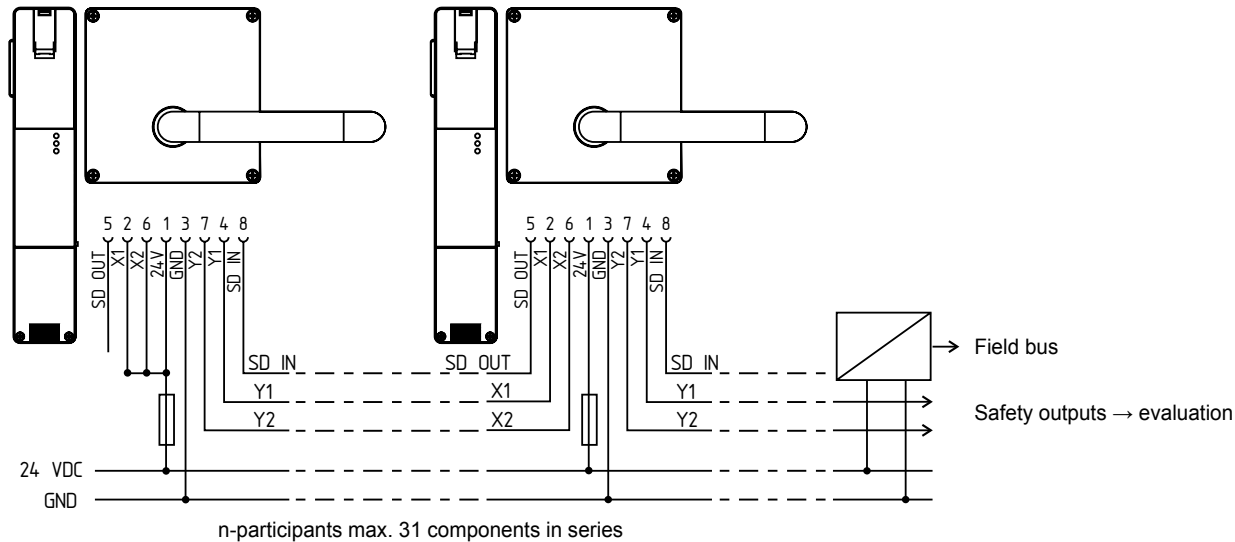

9.2 Wiring configuration and connector accessories

Function safety switchgear		Pin configuration of the connector	Configuration of the removable terminal blocks	Colour code or conductor numbering of the below-mentioned Schmersal connectors		Possible colour code of other commercially available connectors		
						to IEC 60947-5-2: 2007	DIN 47100	
24 V	with conventional diagnostic output	U _e	1	1	BN	1	BN	WH
X1		Safety input 1	2	2	WH	2	WH	BN
GND		GND	3	5	BU	3	BU	GN
Y1		Safety output 1	4	7	BK	4	BK	YE
OUT	Diagnostic output	SD output	5	9	GY	5	GY	GY
X2		Safety input 2	6	3	VT	6	PK	PK
Y2		Safety output 2	7	8	RD	7	VT	BU
IN	Solenoid control	SD input	8	4	PK	8	or	RD
		without function	9	6				

Connector plug ST1 M23, (8+1)-pole



Connector plug ST2 M12, 8-pole



Connecting cables with female connector IP67, M23, (8+1)-pole - 8 x 0.75 mm²

Cable length	Part number
5.0 m	101209959
10.0 m	101209958

Connecting cables with female connector IP67, M12, 8-pole - 8 x 0.23 mm²

Cable length	Part number
2.5 m	101209963
5.0 m	101209964
10.0 m	101209960

Connector with plug (female) IP67, M23, (8+1)-pole - 8 x 0.75 mm²

Design	Part number
with soldering terminals	101209970
with crimp terminals	101209994

Connecting cables with female connector IP69K, M12, 8-pole - 8 x 0.21 mm²

Cable length	Part number
5.0 m	101210560
5.0 m	101210561 (angled)

View of the terminal block for ordering suffix -SK or -CC

24V	24V	X1	X2	IN
AZM 200.-.-1P2P.				
GND		Y1	Y2	OUT

24V	24V	X1	X2	IN
AZM 200.-.-SD2P.				
GND		Y1	Y2	OUT

View of the version with removable terminal blocks

1	2	3	4	
AZM 200.-.-1P2P.-.				
5	6	7	8	9

10. EU Declaration of conformity

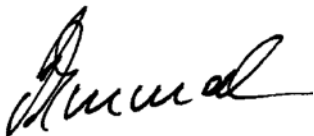
EU Declaration of conformity		 SCHMERSAL
Original	K.A. Schmersal GmbH & Co. KG Möddinghofe 30 42279 Wuppertal Germany Internet: www.schmersal.com	
We hereby certify that the hereafter described components both in their basic design and construction conform to the applicable European Directives.		
Name of the component:	AZM 200	
Type:	See ordering code	
Description of the component:	Interlocking device with electromagnetic interlock for safety functions	
Relevant Directives:	Machinery Directive	2006/42/EC
	EMC-Directive	2014/30/EU
	RoHS-Directive	2011/65/EU
Applied standards:	EN 60947-5-1:2004 + AC:2005 + A1:2009, EN 60947-5-3:2013, ISO 14119: 2013, EN ISO 13849-1:2008 + AC:2009, EN 61508 Teile 1-7: 2010, EN 62061:2005 + AC:2010 + A1:2013	
Notified body for the prototype test:	TÜV Rheinland Industrie Service GmbH Alboinstr. 56, 12103 Berlin ID n°: 0035	
EC-prototype test certificate:	01/205/5122.01/15	
Person authorized for the compilation of the technical documentation:	Oliver Wacker Möddinghofe 30 42279 Wuppertal	
Place and date of issue:	Wuppertal, April 20, 2016	
		
	Authorised signature Philip Schmersal Managing Director	

AZM200-E-EN



The currently valid declaration of conformity can be downloaded from the internet at www.schmersal.net.



K. A. Schmersal GmbH & Co. KG
Möddinghofe 30, D - 42279 Wuppertal
Postfach 24 02 63, D - 42232 Wuppertal

Phone: +49 - (0)2 02 - 64 74 - 0
Telefax: +49 - (0)2 02 - 64 74 - 1 00
E-Mail: info@schmersal.com
Internet: <http://www.schmersal.com>