



EN Operating instructions.pages 1 to 6
Translation of the original operating instructions

Content

1 About this document

1.1 Function 1

1.2 Target group: authorised qualified personnel. 1

1.3 Explanation of the symbols used 1

1.4 Appropriate use 1

1.5 General safety instructions 1

1.6 Warning about misuse 2

1.7 Exclusion of liability 2

2 Product description

2.1 Ordering code 2

2.2 Special versions 2

2.3 Destination and use 2

2.4 Technical data 2

2.5 Safety classification 3

3 Mounting

3.1 General mounting instructions 3

3.2 Dimensions 3

4 Electrical connection

4.1 General information for electrical connection. 3

4.2 Contact variants 3

4.3 Cut clamp terminals 4

5 Set-up and maintenance

5.1 Functional testing. 4

5.2 Maintenance 4

6 Disassembly and disposal

6.1 Disassembly. 4

6.2 Disposal 4

7 Appendix

7.1 EC Declaration of conformity 5

1. About this document

1.1 Function

This operating instructions manual provides all the information you need for the mounting, set-up and commissioning to ensure the safe operation and disassembly of the safety switchgear. The operating instructions must be available in a legible condition and a complete version in the vicinity of the device.

1.2 Target group: authorised qualified personnel

All operations described in this operating instructions manual must be carried out by trained specialist personnel, authorised by the plant operator only.

Please make sure that you have read and understood these operating instructions and that you know all applicable legislations regarding occupational safety and accident prevention prior to installation and putting the component into operation.

The machine builder must carefully select the harmonised standards to be complied with as well as other technical specifications for the selection, mounting and integration of the components.

1.3 Explanation of the symbols used



Information, hint, note:

This symbol is used for identifying useful additional information.



Caution: Failure to comply with this warning notice could lead to failures or malfunctions.

Warning: Failure to comply with this warning notice could lead to physical injury and/or damage to the machine.

1.4 Appropriate use

The products described in these operating instructions are developed to execute safety-related functions as part of an entire plant or machine. It is the responsibility of the manufacturer of a machine or plant to ensure the correct functionality of the entire machinery or plant.

The safety switchgear must be exclusively used in accordance with the versions listed below or for the applications authorised by the manufacturer. Detailed information regarding the range of applications can be found in the chapter "Product description".

1.5 General safety instructions

The user must observe the safety instructions in this operating instructions manual, the country-specific installation standards as well as all prevailing safety regulations and accident prevention rules.



Further technical information can be found in the Schmersal catalogues or in the online catalogue on the Internet: www.schmersal.net.

The information contained in this operating instructions manual is provided without liability and is subject to technical modifications.



If multiple safety components are wired in series, the Performance Level to EN ISO 13849-1 will be reduced due to the restricted error detection under certain circumstances. The entire concept of the control system, in which the safety component is integrated, must be validated to EN ISO 13849-2.

There are no residual risks, provided that the safety instructions as well as the instructions regarding mounting, commissioning, operation and maintenance are observed.

1.6 Warning about misuse



In case of inadequate or improper use or manipulations of the safety switchgear, personal hazards or damage to machinery or plant components cannot be excluded. The relevant requirements of the standard EN 1088 must be observed.

1.7 Exclusion of liability

We shall accept no liability for damages and malfunctions resulting from defective mounting or failure to comply with this operating instructions manual. The manufacturer shall accept no liability for damages resulting from the use of unauthorised spare parts or accessories.

For safety reasons, invasive work on the device as well as arbitrary repairs, conversions and modifications to the device are strictly forbidden; the manufacturer shall accept no liability for damages resulting from such invasive work, arbitrary repairs, conversions and/or modifications to the device.

2. Product description

2.1 Ordering code

This operating instructions manual applies to the following types:

EX-AZM 170-①Z②K③-24VAC/DC-④-3G/D

No.	Option	Description
①	11 02	1 NO contact / 1 NC contact 2 NC contacts
②	R	Latching force 5 N Latching force 30 N
③	A	Power to unlock Power to lock
④	2197 1637	Manual release Manual release from side Gold-plated contacts



Only if the information described in this operating instructions manual are realised correctly, the safety function and therefore the compliance with the Machinery Directive and the Explosion Protection Directive is maintained.

2.2 Special versions

For special versions, which are not listed in the order code below 2.1, these specifications apply accordingly, provided that they correspond to the standard version.

2.3 Destination and use

The solenoid interlock has been designed to prevent in conjunction with the control part of a machine, movable safety guards from being opened before hazardous conditions have been eliminated. The components can be used in explosion-endangered areas of Zone 2 and 22 equipment category 3 GD. The installation and maintenance requirements to the standard series EN 60079 must be met.

Conditions for safe operation

Due to the specific impact energy, the components must be fitted with a protection against mechanical stresses. The specific ambient temperature range must be observed. The user must provide for a protection against the permanent influence of UV rays.



Solenoid interlocks with power to lock principle may only be used in special cases after a thorough evaluation of the risk of accident, since the safety guard can be opened immediately on failure of the power supply or upon activation of the main switch.

Manual release

The locking bolt is pulled into the unlocking position by turning the triangular key. The normal locking function is only restored after the triangular key has been returned to its original position. After being put into operation, the manual release must be secured by installing the plastic cover, which is included in delivery.

Manual release

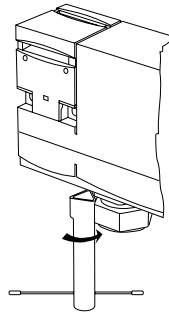

Manual release from side Ordering suffix -2197

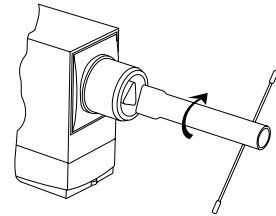

The user must evaluate and design the safety chain in accordance with the relevant standards and the required safety level.

2.4 Technical data

Equipment category:	⊕ II 3GD
Ex protection:	Ex t IIIC T80°C Dc X, Ex nC IIB T5 Gc X
Standards:	EN 60947-5-1, EN 60079-0, EN 60079-15, EN 60079-31, BG-GS-ET-19
Enclosure:	glass-fibre reinforced thermoplastic, self-extinguishing
Max. impact energy:	1 J
Actuating speed:	max. 1 ms
Actuator and locking bolt:	stainless steel 1.4301
Protection class:	IP67 to EN 60529
Contact material:	Silver
Contact type:	change-over with double break Zb, or 2 NC contacts, galvanically separated contact bridges
Switching system:	⊖ EN 60947-5-1, slow action, NC contact with positive break
Connection:	cut clamp terminals
Cable section:	0.75 – 1.0 mm ² , flexible
Rated impulse withstand voltage U _{imp} :	4 kV
Rated insulation voltage U _i :	250 V
Thermal test current I _{th} :	2 A
Utilisation category:	AC-15 / DC-13
Operating current I _e :	2 A / 230 VAC
Rated operating voltage U _e :	2 A / 24 VDC
Max. fuse rating:	2 A gG D-fuse
Required short-circuit current:	1000 A
Positive break travel:	11 mm
Positive break force:	6 N for each NC contact fitted
Rated control voltage U _s :	24 VAC / DC
Magnet:	100% ED
Power consumption:	max. 10 W
Ambient temperature:	-15 °C ... +45 °C
Mechanical life:	max. 1 million operations
Clamping force F _{max} :	1000 N
Latching force:	30 N for ordering suffix R
Tightening torque	
- Cover screws:	0.4 - 0.5 Nm (cylinder-head screw M3 x 20)
- Tightening torque cable gland:	4.5 Nm
Cable glands:	⊕ II 2GD
Cable cross-section:	min. Ø 6.5 mm; max. Ø 12 mm

2.5 Safety classification

Standards:	EN ISO 13849-1
B _{10d} (NC contact):	2.000.000
B _{10d} (NO contact)	
at 10% ohmic contact load:	1.000.000
Service life:	20 years

$$MTTF_d = \frac{B_{10d}}{0,1 \times n_{op}} \quad n_{op} = \frac{d_{op} \times h_{op} \times 3600 \text{ s/h}}{t_{cycle}}$$

(Specifications can vary depending on the application-specific parameters h_{op} , d_{op} and t_{cycle} as well as the load.)

3. Mounting

3.1 General mounting instructions



Fitting is only authorised in a de-energised condition

The enclosure can be fixed by means of 2 mounting holes. The solenoid interlock is double insulated. The use of an earth wire is not authorised. The enclosure must not be used as an end stop. Any mounting position. The mounting position however must be chosen so that the ingress of dirt and soiling in the used opening is avoided. The unused openings must be sealed by means of slot sealing plugs after fitting.



Please observe the recommendations regarding maximum impact energy, actuating speed and tightening torque in the technical data.

Mounting of the actuators: See mounting instructions actuators.



Please observe the remarks of the standards EN ISO 12100, EN 953 and EN 1088.

3.2 Dimensions

All measurements in mm.

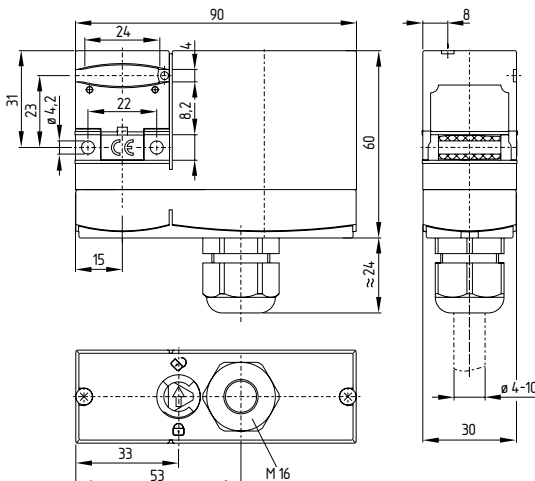

4. Electrical connection

4.1 General information for electrical connection



The electrical connection may only be carried out by authorised personnel in a de-energised condition.

The contact labelling can be found in the wiring compartment of the switch.



At least one magnetic contact ⊖ with positive break contacts must be integrated in the safety circuit.

Cable glands (included in delivery) are only authorised for permanent cables. The constructor must provide for the necessary strain relief.

4.2 Contact variants

Contacts shown in a de-energised condition and with the actuator inserted.

Power to unlock

EX-AZM 170-11ZRK-3G/D

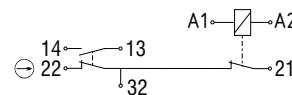

EX-AZM 170-02ZRK-3G/D

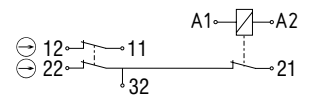

Power to lock

EX-AZM 170-11ZRKA-3G/D

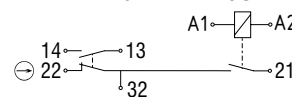

EX-AZM 170-02ZRKA-3G/D

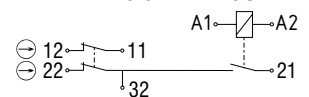

Legend

- ⊖ positive break
- Ⓢ actuated
- Ⓣ not actuated

4.3 Cut clamp terminals

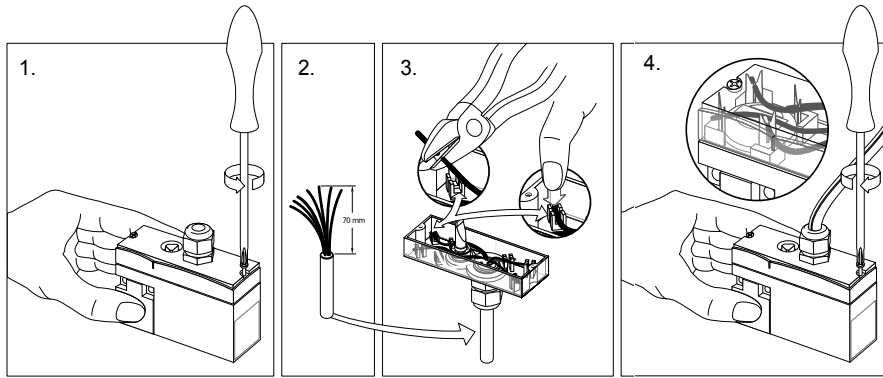

5. Set-up and maintenance

5.1 Functional testing

The safety function of the safety components must be tested. The following conditions must be previously checked and met:

- The installation is executed according to the instructions
- The connection is executed correctly
- The cable is correctly executed and connected
- The sealing is correctly located in the enclosure. (Do not remove the sealing!)
- The safety component is not damaged
- Remove particles of dust and soiling
- Check cable entry and connections

5.2 Maintenance

In case of correct installation in accordance with the above-described instructions, the component requires little maintenance. By use in extreme conditions, we recommend routine maintenance including the following steps:

1. Check the proper fixation of the actuator and the safety switchgear
2. Remove particles of dust and soiling
3. Check cable entry and connections in a de-energised condition



Caution: avoid electrostatic charging. Clean with damp cloth. Do not open the device when live.

Damaged or defective components must be replaced.

For explosion protection reasons, the component must be exchanged after max. 1 million operations.

6. Disassembly and disposal

6.1 Disassembly

The safety switchgear must be disassembled in a de-energised condition only.

6.2 Disposal

The safety switchgear must be disposed of in an appropriate manner in accordance with the national prescriptions and legislations.

7. Appendix

7.1 EC Declaration of conformity

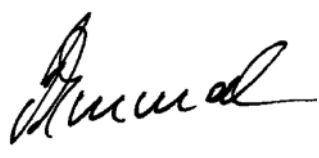
	
<h2>EC Declaration of conformity</h2>	
Translation of the original declaration of conformity K. A. Schmersal GmbH & Co. KG Industrielle Sicherheitssysteme Mödinghofe 30, 42279 Wuppertal Germany Internet: www.schmersal.com	
We hereby certify that the hereafter described safety components both in its basic design and construction conform to the applicable European Directives.	
Name of the safety component:	EX-AZM 170 ⊗ II 3G Ex nC IIB T5 Gc X ⊗ II 3D Ex t IIIC T80°C Dc X
Description of the safety component:	Interlocking device with electromagnetic interlock for safety functions
Relevant EC-Directives:	2006/42/EC-EC-Machinery Directive 2004/108/EC EMC-Directive 94/9/EC EC-Explosion Protection Directive (ATEX)
Person authorized for the compilation of the technical documentation:	Oliver Wacker Mödinghofe 30 42279 Wuppertal
Place and date of issue:	Wuppertal, September 17, 2012
EX-AZM 170-C-EN	
	Authorised signature Philip Schmersal Managing Director



The currently valid declaration of conformity can be downloaded from the internet at www.schmersal.net.



K. A. Schmersal GmbH & Co. KG
Industrielle Sicherheitssysteme
Möddinghofe 30, D - 42279 Wuppertal
Postfach 24 02 63, D - 42232 Wuppertal

Phone: +49 - (0)2 02 - 64 74 - 0
Telefax +49 - (0)2 02 - 64 74 - 1 00
E-Mail: info@schmersal.com
Internet: <http://www.schmersal.com>