

XCC1406PR03K

incremental encoder Ø 40 - solid shaft 6 mm -
360 points - push-pull



Main

Range of product	OsiSense XCC
Encoder type	Incremental encoder
Encoder name	XCC
Product specific application	-
Diameter	40 mm
Shaft diameter	6 mm
Shaft type	Solid shaft
Resolution	360 points
Output stage	Type K
Type of output stage	Driver push-pull
Electrical connection	Cable radial shielded
Cable length	2 m
Cable composition	8 x 0.14 mm ²
[Us] rated supply voltage	11...30 V DC
Enclosure material	Aluminium Zamak

Complementary

Shaft tolerance	G7
Cable outer diameter	6 mm
Residual ripple	0...500 mV
Maximum revolution speed	9000 rpm
Shaft moment of inertia	10 g.cm ²
Torque value	0.002 N.m
Maximum load	2 daN radial 1 daN axial
Output frequency	100 kHz
Number of channels	3
Current consumption	0...75 mA (no-load)
Protection type	Reverse polarity protection Short-circuit protection
Maximum output current	40 mA
Output level	High level: V supply - 3 V minimum (20 mA) Low level: 1.5 V maximum (20 mA)
Surge withstand	1 kV, level 2 conforming to IEC 61000-4-5
Base material	Aluminium Zamak
Shaft material	Aluminium Stainless steel
Type of ball bearings	688AZZ1
Product weight	0.355 kg

The information provided in this documentation contains general descriptions and/or technical characteristics of the performance of the products contained herein. This documentation is not intended as a substitute for and is not to be used for determining suitability or reliability of these products for specific user applications. It is the duty of any such user or integrator to perform the appropriate and complete risk analysis, evaluation and testing of the products with respect to the relevant specific application or use thereof. Neither Schneider Electric Industries SAS nor any of its affiliates or subsidiaries shall be responsible or liable for misuse of the information contained herein.

Environment

Marking	CE
Ambient air temperature for operation	-20...80 °C
Ambient air temperature for storage	-30...85 °C
IP degree of protection	IP54 conforming to IEC 60529
Vibration resistance	10 gn (f = 10...500 Hz) conforming to IEC 60068-2-6
Shock resistance	30 gn for 11 ms conforming to IEC 60068-2-27
Resistance to electrostatic discharge	8 kV (air discharge) level 3 conforming to IEC 61000-4-2 4 kV (contact discharge) level 3 conforming to IEC 61000-4-2
Resistance to electromagnetic fields	10 V/m level 3 conforming to IEC 61000-4-3
Resistance to fast transients	2 kV (power ports) level 3 conforming to IEC 61000-4-4 1 kV (signal ports) level 3 conforming to IEC 61000-4-4

Offer Sustainability

Sustainable offer status	Not Green Premium product
RoHS (date code: YYWW)	Compliant - since 0701 - Schneider Electric declaration of conformity
REACH	Reference not containing SVHC above the threshold

Dimensions

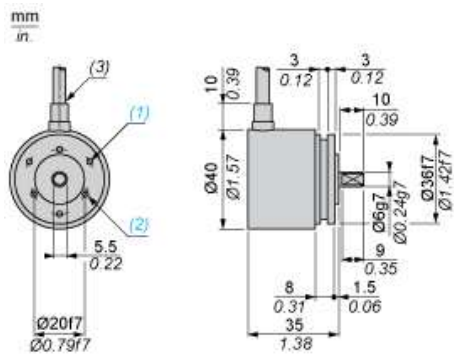

- (1) 3 holes M3 x 0.5 at 120° on 28 PCD, depth: 5 mm
- (2) 3 holes M3 x 0.5 at 120° on 24 PCD, depth: 5 mm
- (3) $\varnothing 6$ cable, length 2 m, minimum bend radius: 30 mm

Wiring Diagram

Type K Output Stage

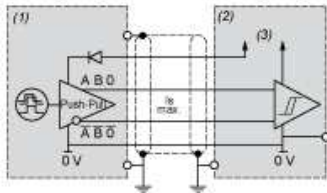

- (1) Encoder
- (2) Processing
- (3) Supply 11 V/30 V

Wiring Diagram

Cable Connections

Wire colour	BN	RD	VT	BU	YE	OG	GN	BK
Signal Supply	A ⁻	+V	0	0 ⁻	B	B ⁻	A	0V

- BN = Brown
- RD = Red
- VT = Violet
- BU = Blue
- YE = Yellow
- OG = Orange
- GN = Green
- BK = Black