



## Main

Range of product	OsiSense XCC
Encoder type	Multiturn absolute encoder
Encoder name	XCC
Product specific application	-
Diameter	58 mm
Shaft diameter	6 mm
Shaft type	Solid shaft
Resolution	4096 points/8192 turns
Electrical connection	1 male connector M23 radial 12 pins
Output stage	Type SG
Type of output stage	SSI 25-bit gray
[Us] rated supply voltage	11...30 V DC
Enclosure material	Steel

## Complementary

Shaft tolerance	G7
Residual ripple	0...500 mV
Maximum revolution speed	6000 rpm
Shaft moment of inertia	10 g.cm <sup>2</sup>
Torque value	0.004 N.m
Maximum load	5 daN axial 10 daN radial
Output frequency	100...500 kHz
Current consumption	0...100 mA no-load
Protection type	Reverse polarity protection Short-circuit protection
Physical interface	RS422
Output level	High level: 2 V minimum 20 mA
Surge withstand	1 kV level 2 IEC 61000-4-5
Base material	Aluminium
Shaft material	Stainless steel
Type of ball bearings	6900ZZ1
Product weight	0.725 kg

## Environment

Marking	CE
Ambient air temperature for operation	-20...85 °C
Ambient air temperature for storage	-20...85 °C
IP degree of protection	IP65 IEC 60529
Vibration resistance	10 gn (10...2000 Hz) IEC 60068-2-6
Shock resistance	30 gn (11 ms) IEC 60068-2-27
Resistance to electrostatic discharge	8 kV air discharge level 3 IEC 61000-4-2 4 kV contact discharge level 3 IEC 61000-4-2
Resistance to electromagnetic fields	10 V/m level 3 IEC 61000-4-3
Resistance to fast transients	2 kV power ports level 3 IEC 61000-4-4 1 kV signal ports level 3 IEC 61000-4-4

## Offer Sustainability

Sustainable offer status	Not Green Premium product
RoHS (date code: YYWW)	Compliant - since 0701 - <a href="#">Schneider Electric declaration of conformity</a>
REACH	Reference not containing SVHC above the threshold

Dimensions

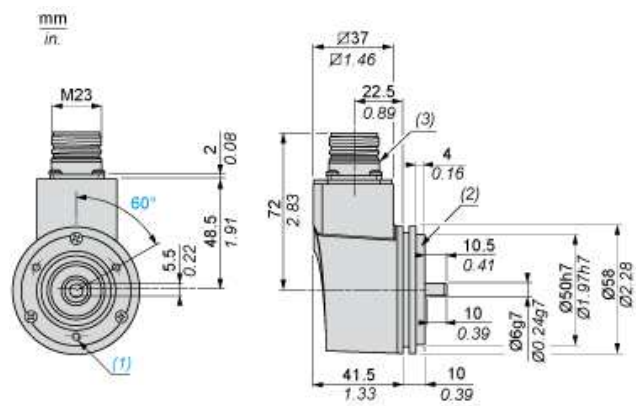

- (1) 3 M4 holes at 120° on 42 PCD, depth: 10 mm
- (2) Collar XCCRB1 mounted
- (3) Nitrile seal



Wiring Diagram

M23, 12-pin Connector, Anticlockwise Connections

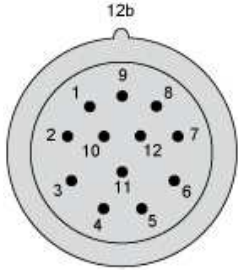
Male Connector on Encoder



Pin number	1	2	3	4	5	6	7	8	9	10	11	12
Signal Supply	0 V	Data +	Clk +	R	Direction (1)	Reset to zero	R	+ V	R	Data -	Clk -	R

- (1)  : Clockwise direction  
 : Anticlockwise direction

R = Reserved (do not connect)

Technical Description

RS 422 Data Output

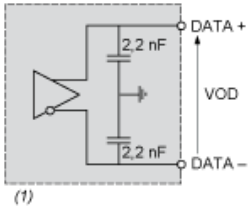

(1)  $I_{data} = 20 \text{ mA}$   $|VOD| > 2 \text{ V}$

Isolated Clock Input

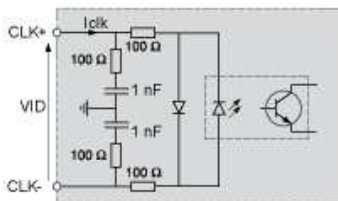

VID maximum: 5 V  
 Iclk maximum: 15 mA

DIRECTION Input

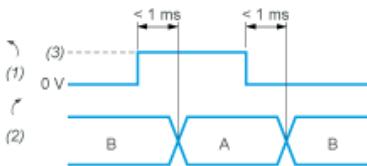

- A : Anticlockwise
- B : Clockwise
- (1) DIRECTION input
- (2) DIRECTION of counting
- (3) V supply

Input Stage - Reset to Zero

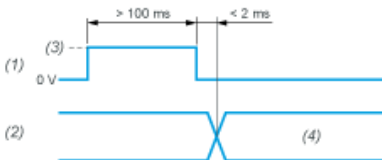

- (1) Reset input
- (2) Position
- (3) V supply
- (4) Position=0 (Reset to zero)