

XUVR0605PANM8

photo-electric sensor - XUV - fork - 50X60mm - 12..24VDC - M8



Main

Range of product	OsiSense XU
Series name	General purpose
Electronic sensor type	Photo-electric sensor
Sensor name	XUVR
Sensor design	Fork
Detection system	Thru beam
Emission	Red LED, modulated
Passage width	50 mm
Passage depth	60 mm
Material	Metal/Plastic
Supply circuit type	DC
Wiring technique	3-wire
Discrete output type	PNP
Discrete output function	1 NO
Electrical connection	1 male connector M8, 3 pins
Product specific application	Detection on small conveyor
[Sn] nominal sensing distance	50 mm

Complementary

Enclosure material	Painted aluminium and polyamide/glass
Spot diameter	0.8 mm
Type of output signal	Discrete
Output type	Solid state
Status LED	1 LED (yellow) for output state
[Us] rated supply voltage	12...24 V DC with reverse polarity protection
Supply voltage limits	10...30 V DC
Switching capacity in mA	100 mA (overload and short-circuit protection)
Switching frequency	4000 Hz
Voltage drop	<= 1.5 V (closed state)
Current consumption	< 20 mA (no-load)
Product weight	0.08...0.19 kg

Environment

Product certifications	CE CSA UL
Ambient air temperature for operation	-10...60 °C
Ambient air temperature for storage	-40...80 °C
Immunity to ambient light	10000 lux with natural light 5000 lux with incandescent bulb
Vibration resistance	7 gn, amplitude = +/- 0.75 mm (f = 10...55 Hz) conforming to IEC 60068-2-6
Shock resistance	30 gn (duration = 11 ms) conforming to IEC 60068-2-27
IP degree of protection	IP65 IP67

Dimensions

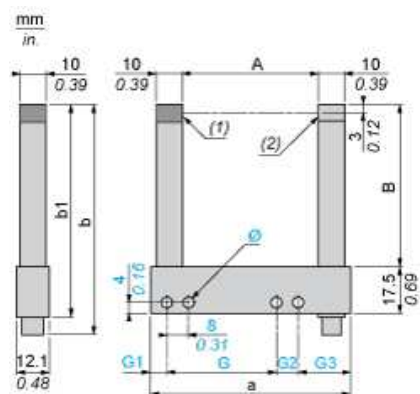

- (1) Transmission LED
- (2) Yellow LED: output signal

Dimensions in mm

Passageway A	Depth B	a	b	b1	G	G1	G2	G3	∅
50	60	74	85.7	77.5	40	6.5	8	19.5	4 x 4.3

Dimensions in in.

Passageway A	Depth B	a	b	b1	G	G1	G2	G3	∅
1.97	2.36	2.91	3.37	3.05	1.57	0.26	0.31	0.77	0.16 x 0.17

Wiring Schemes

M8 Connector

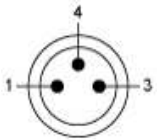

- 1 : BN: Brown
- 3 : BU: Blue
- 4 : BK: Black

PNP Output

