



## Main

Accessory / separate part category	Cabling accessory
Accessory / separate part type	Pre-wired connectors
Series name	General purpose

## Complementary

Electrical connection	Elbowed female connector, connector type: M12 5 pins (included earth pin)
Cable connector fixing	Screw-on
Collar material	Metal
Status LED	Without
Cable length	5 m
Cable outer diameter	5.9 mm
Cable composition	5 x 0.34 mm <sup>2</sup>
Wire insulation material	PUR
[Ue] rated operational voltage	60 V AC 75 V DC
[In] rated current	4 A
Contact resistance	<= 5000 µOhm
Insulating resistance	>= 1 GΩ
Product weight	0.27 kg

## Environment

IP degree of protection	IP65 IP67 IP69K
Ambient air temperature for operation	-40...80 °C (static) -5...80 °C (flexing)
Ambient air temperature for storage	-40...80 °C

## Offer Sustainability

Sustainable offer status	Green Premium product
RoHS (date code: YYWW)	Compliant - since 0649 - <a href="#">Schneider Electric declaration of conformity</a>
REACH	Reference not containing SVHC above the threshold
Product environmental profile	Available <a href="#">Download Product Environmental</a>
Product end of life instructions	Available <a href="#">Download End Of Life Manual</a>

## Dimensions

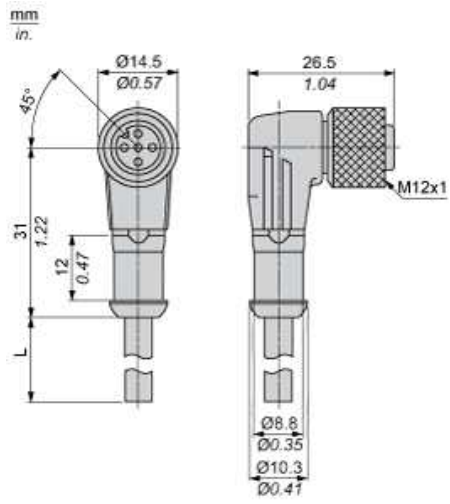

L : Length of cable

---

## Connections and Schemes

---

### Connectors

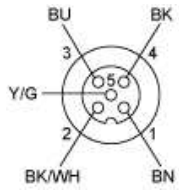

BU : Blue  
BN : Brown  
BK : Black  
Y/G : Yellow / Green  
BK/ Black / White  
WH :