



Main

Range of product	OsiSense XCC
Encoder type	Incremental encoder
Encoder name	XCC
Product specific application	-
Diameter	90 mm
Shaft diameter	12 mm
Shaft type	Solid shaft
Resolution	1000 points
Output stage	Type R
Type of output stage	Driver 5V, RS422
Electrical connection	1 male connector M23 radial 12 pins
[Us] rated supply voltage	5 V DC
Supply voltage limits	4.5...5.5 V DC
Enclosure material	Zamak

Complementary

Shaft tolerance	G6
Residual ripple	0...200 mV
Maximum revolution speed	6000 rpm
Shaft moment of inertia	150 g.cm ²
Torque value	0.01 N.m
Maximum load	20 daN radial 10 daN axial
Output frequency	100 kHz
Number of channels	3
Current consumption	0...100 mA (no-load)
Maximum output current	40 mA
Output level	High level: V supply - 2.5 V minimum (20 mA) Low level: 0.5 V maximum (20 mA)
Surge withstand	1 kV, level 2 conforming to IEC 61000-4-5
Base material	Aluminium
Shaft material	Stainless steel
Type of ball bearings	6001ZZ
Product weight	1.36 kg

Environment

Marking	CE
Ambient air temperature for operation	-20...80 °C
Ambient air temperature for storage	-30...85 °C
IP degree of protection	IP66 conforming to IEC 60529
Vibration resistance	10 gn (f = 10...1000 Hz) conforming to IEC 60068-2-6
Shock resistance	30 gn for 11 ms conforming to IEC 60068-2-27
Resistance to electrostatic discharge	8 kV (air discharge) level 3 conforming to IEC 61000-4-2 4 kV (contact discharge) level 3 conforming to IEC 61000-4-2
Resistance to electromagnetic fields	10 V/m level 3 conforming to IEC 61000-4-3
Resistance to fast transients	2 kV (power ports) level 3 conforming to IEC 61000-4-4 1 kV (signal ports) level 3 conforming to IEC 61000-4-4

Offer Sustainability

Sustainable offer status	Not Green Premium product
RoHS (date code: YYWW)	Compliant - since 0701 - Schneider Electric declaration of conformity

Dimensions

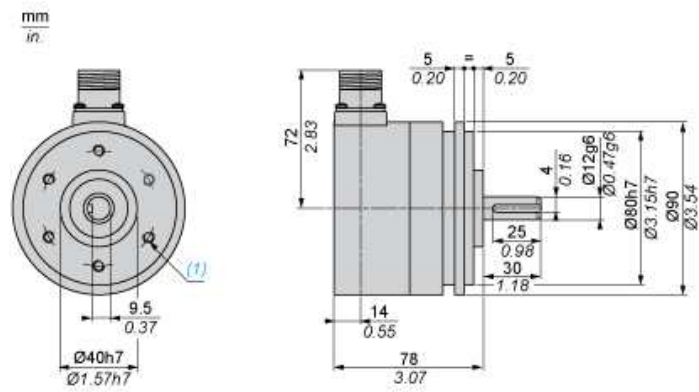

(1) 6 holes M6 x 1 at 120° on 60 PCD, maximum depth: 12 mm

Wiring Diagram

Type R Output Stage

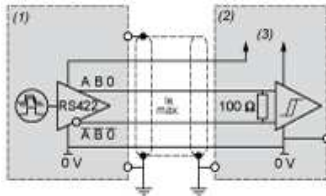

- (1) Encoder
- (2) Processing
- (3) Supply 5 V

Wiring Diagram

M23, 12-pin Connector Connections

Male Connector on Encoder

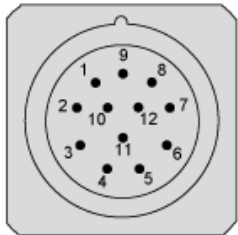

Pin number	1	2	3	4	5	6	7	8	9	10	11	12
Signal Supply	A ⁻	+V	0	0 ⁻	B	B ⁻	R	A	R	0 V	0 V	+V

R = reserved, do not connect