



Main

Accessory / separate part category	Cabling accessory
Accessory / separate part type	Pre-wired connectors
Series name	General purpose

Complementary

Electrical connection	Elbowed female connector, connector type: M12 4 pins
Cable connector fixing	Screw-on
Collar material	Metal
Status LED	Without
Cable length	2 m
Cable outer diameter	5.2 mm
Cable composition	4 x 0.34 mm ²
Wire insulation material	PUR
[Ue] rated operational voltage	250 V AC 300 V DC
[In] rated current	4 A
Contact resistance	<= 5000 µOhm
Insulating resistance	>= 1 GΩ
Product weight	0.09 kg

Environment

IP degree of protection	IP65 IP67 IP69K
Ambient air temperature for operation	-40...80 °C (static) -5...80 °C (flexing)
Ambient air temperature for storage	-40...80 °C

Offer Sustainability

Sustainable offer status	Green Premium product
RoHS (date code: YYWW)	Compliant - since 0649 - Schneider Electric declaration of conformity
REACH	Reference not containing SVHC above the threshold
Product environmental profile	Available Download Product Environmental
Product end of life instructions	Available Download End Of Life Manual

Dimensions

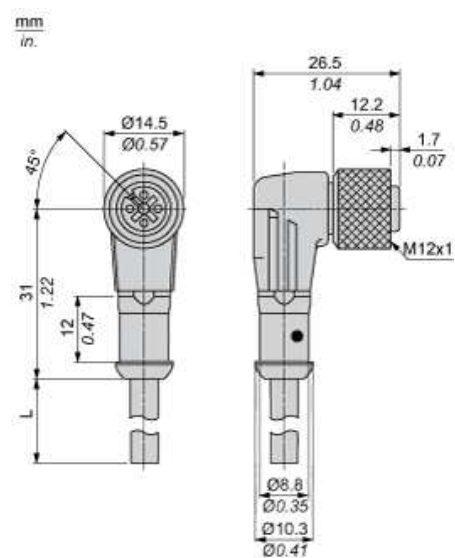

L : Length of cable

Connections and Schemes

Connector

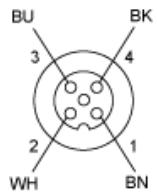

BN : Brown
BK : Black
BU : Blue
WH : White