

XCC2514TS81SG

absolute encoder Ø 58 single turn - through shaft 14 mm - push-pull 13-bit Gray



Main

Range of product	OsiSense XCC
Encoder type	Single turn absolute encoder
Encoder name	XCC
Product specific application	-
Diameter	58 mm
Shaft diameter	14 mm
Shaft type	Through shaft
Resolution	8192 points
Electrical connection	1 male connector M23 radial 12 pins
Output stage	Type SG
Type of output stage	SSI 13-bit gray
[Us] rated supply voltage	11...30 V DC
Enclosure material	Zamak

Complementary

Shaft tolerance	H7
Residual ripple	0...500 mV
Maximum revolution speed	6000 rpm
Shaft moment of inertia	22 g.cm ²
Torque value	0.006 N.m
Maximum load	5 daN radial 2 daN axial
Output frequency	100...1000 kHz
Current consumption	0...100 mA no-load
Protection type	Reverse polarity protection Short-circuit protection
Maximum output current	20 mA
Physical interface	RS422
Output level	High level: 2 V minimum 20 mA
Surge withstand	1 kV level 2 IEC 61000-4-5
Base material	Aluminium
Shaft material	Stainless steel
Type of ball bearings	6803ZZ
Product weight	0.43 kg

Environment

Marking	CE
Ambient air temperature for operation	-20...90 °C
Ambient air temperature for storage	-30...85 °C
IP degree of protection	IP65 IEC 60529
Vibration resistance	10 gn (10...2000 Hz) IEC 60068-2-6
Shock resistance	30 gn (11 ms) IEC 60068-2-27
Resistance to electrostatic discharge	8 kV air discharge level 3 IEC 61000-4-2 4 kV contact discharge level 3 IEC 61000-4-2
Resistance to electromagnetic fields	10 V/m level 3 IEC 61000-4-3
Resistance to fast transients	2 kV power ports level 3 IEC 61000-4-4 1 kV signal ports level 3 IEC 61000-4-4

Offer Sustainability

Sustainable offer status	Not Green Premium product
RoHS (date code: YYWW)	Compliant - since 0701 - Schneider Electric declaration of conformity
REACH	Reference not containing SVHC above the threshold

Dimensions

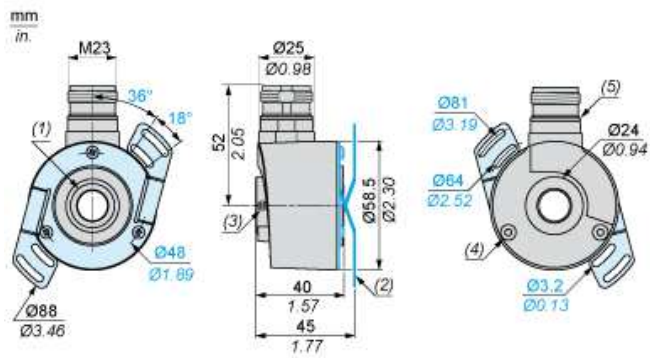

- (1) Through shaft, Ø 14 (H7)
- (2) Flexible mounting kit, 1 x XCCRF5N mounted
- (3) 2 HC M4 x 4 locking screws
- (4) Hole for M3 x 6 self-threading screw
- (5) Nitrile seal



Wiring Diagram

M23, 12-pin Connector, Anticlockwise Connections

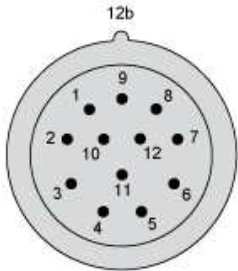
Male Connector on Encoder



Pin number	1	2	3	4	5	6	7	8	9	10	11	12
Signal Supply	0 V	Data +	Clk +	R	Direction (1)	R	R	+ V	R	Data -	Clk -	R

- (1)  : Clockwise direction, 5 to 0 V
 : Anticlockwise direction, 5 to + V

R = Reserved (do not connect)

Technical Description

RS 422 Data Output

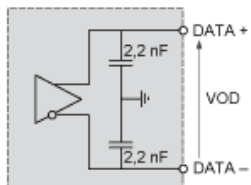

(1) $I_{data} = 20 \text{ mA}$ $|VOD| > 2 \text{ V}$

Isolated Clock Input

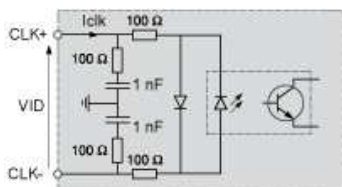

VID maximum: 5 V

Iclk maximum: 15 mA

DIRECTION Input

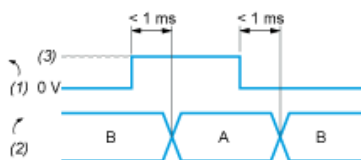

A : Anticlockwise

B : Clockwise

(1) DIRECTION input

(2) DIRECTION of counting

(3) V supply