



Main

Accessory / separate part category	Cabling accessory
Accessory / separate part type	Pre-wired connectors
Series name	General purpose

Complementary

Electrical connection	Elbowed female connector, connector type: Ø 8 mm 3 pins
Cable connector fixing	Clip-on
Status LED	2 NPN LEDs
Cable length	2 m
Cable outer diameter	5.2 mm
Cable composition	3 x 0.34 mm ²
Wire insulation material	PUR
[Ue] rated operational voltage	10...30 V DC
[In] rated current	4 A
Contact resistance	<= 5000 µOhm
Insulating resistance	>= 1 GΩ
Product weight	0.05 kg

Environment

IP degree of protection	IP65 IP67
Ambient air temperature for operation	-40...80 °C (static) -5...80 °C (flexing)
Ambient air temperature for storage	-40...80 °C

Offer Sustainability

Sustainable offer status	Green Premium product
RoHS (date code: YYWW)	Compliant - since 0726 - Schneider Electric declaration of conformity
REACH	Reference not containing SVHC above the threshold
Product environmental profile	Available Download Product Environmental
Product end of life instructions	Available Download End Of Life Manual

Dimensions

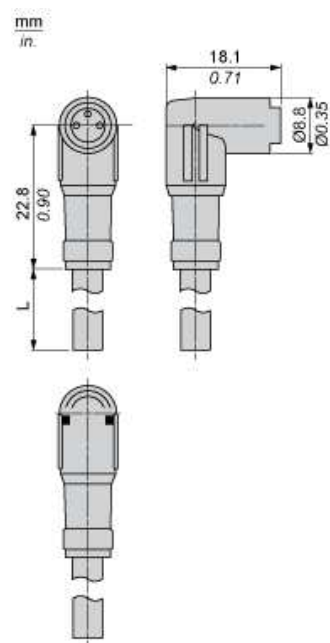

L : Length of cable

Connections and Schemes

Connector

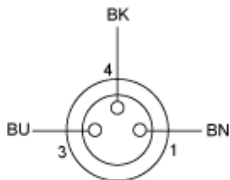

BU : Blue
BN : Brown
BK : Black

Connections and Schemes

LED Connection

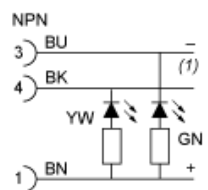

BU : Blue
BK : Black
BN : Brown
GN : Green
YW : Yellow
(1) Signal