



## Luminescence sensors LUT3, LUT3-6

LUT3-610



**Model Name** > LUT3-610  
**Part No.** > 1015396



**At a glance**

- Tough metal housing
- Sensing distance: 10, 20 or 50 mm
- Sensing distances selectable through interchangeable lenses
- Transmitter LED UV (375 nm)

**Your benefits**

- Sensitivity of the sensor can be infinitely adjusted using a potentiometer, saves time and reduces costs
- Filters ensure that background luminescence is reliably suppressed, ensuring greater process reliability
- Interchangeable lenses for different sensing distances provide flexibility



**Features**

Sensing distance <sup>1)</sup> :	10 mm
Operating range:	0 mm 15 mm
Light source <sup>2)</sup> :	LED
Type of light:	Ultraviolet light
Wave length:	375 nm
Light emission:	Long side
Light spot size:	2 mm x 6 mm
Light spot direction:	Vertical
Receiving filters:	KV 418 (standard)
Receiving range:	450 nm ... 750 nm
Adjustment:	Manual (potentiometer)
Output function:	Light switching
Dimensions (W x H x D):	30.4 mm x 53 mm x 80 mm
Housing design (light emission):	Rectangular

<sup>1)</sup> From front edge of lens <sup>2)</sup> Average service life of 100,000 h at T<sub>A</sub> = +25 °C

**Mechanics/electronics**

Ripple <sup>1)</sup> :	< 2 Vpp
Current consumption <sup>2)</sup> :	< 60 mA
Switching frequency <sup>3)</sup> :	1.5 kHz
Response time <sup>4)</sup> :	350 µs
Output type:	NPN: HIGH = approx. VS / LOW ≤ 2 V PNP: HIGH = VS- ≤ 3 V / LOW = approx. 0 V

Switching mode:	PNP/NPN
Output current I <sub>max.</sub> :	100 mA
Connection type:	Connector M12, 4-pin
Protection class <sup>5)</sup> :	II
Circuit protection:	Output Q short-circuit protected Interference suppression VS connections reverse-polarity protected
Enclosure rating:	IP 67
Weight:	400 g
Housing material:	Metal, Zinc diecast
Supply voltage:	12 V DC ... 30 V DC <sup>6)</sup>
Fieldbus interface:	-

1) May not exceed or fall short of V<sub>S</sub> tolerances 2) Without load 3) With light/dark ratio 1:1 4) Signal transit time with resistive load 5) Reference voltage DC 50 V 6)

Limit values; operation in short-circuit protected network max. 8 A

### Ambient data

Shock load:	According to IEC 60068
Ambient operating temperature:	-10 °C ... +55 °C
Ambient storage temperature:	-25 °C ... +75 °C
UL File No.:	NRKH.E181493 & NRKH7.E181493

### Dimensional drawing

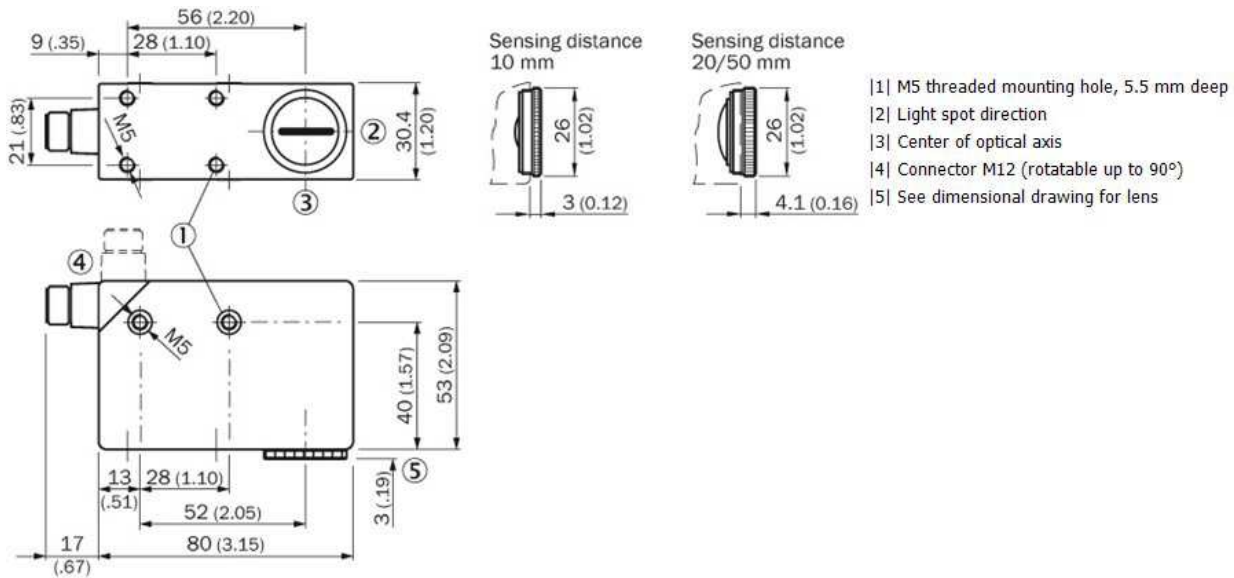

## Adjustments

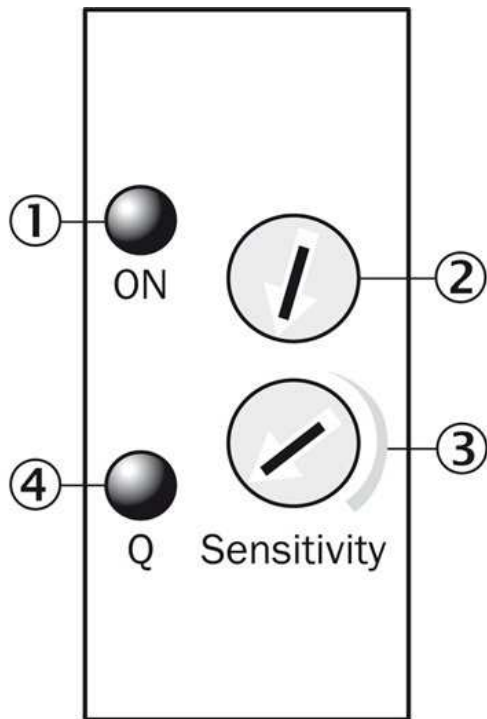

- |1| Function signal indicator (green)
- |2| not connected
- |3| Sensitivity adjustment
- |4| Function signal indicator (yellow), switching output

## Bedienhinweis

### 1. Position mark

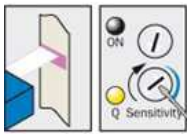

Turn "Sensitivity" rotary switch clockwise until yellow LED illuminates.

### 2. Position background

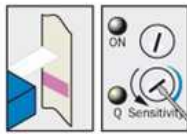

If yellow LED illuminates, turn "Sensitivity" rotary switch counter-clockwise until the yellow LED just goes out.

### Sensitivity setting

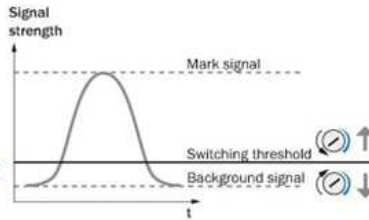

### Note

Adjustments are intended for luminescence background suppression.

## Light spot size

Sensing distance 10 mm

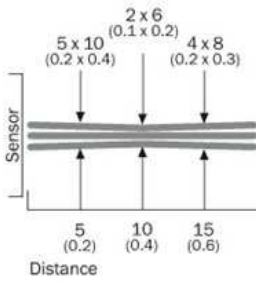

Sensing distance 20 mm

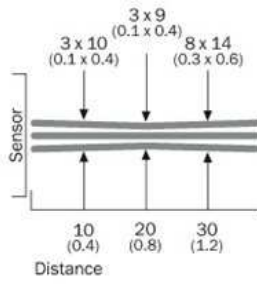

Sensing distance 50 mm

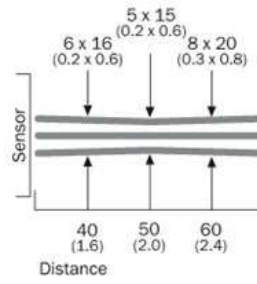

All dimensions in mm (inch)

## Sensing distance

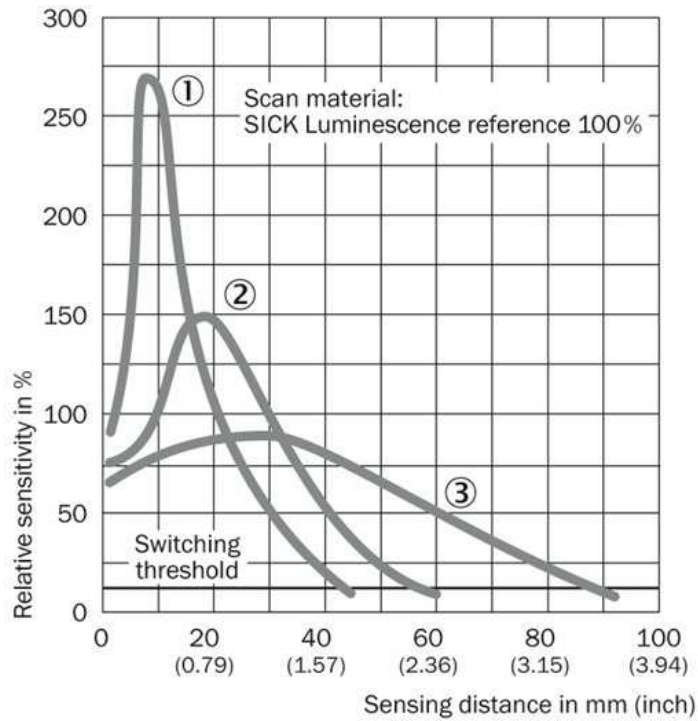

- |1| Sensing distance 10 mm
- |2| Sensing distance 20 mm
- |3| Sensing distance 50 mm

**Australia**

Phone +61 3 9457 0600  
1800 33 48 02 – tollfree  
E-Mail sales@sick.com.au

**Belgium/Luxembourg**

Phone +32 (0)2 466 55 66  
E-Mail info@sick.be

**Brasil**

Phone +55 11 3215-4900  
E-Mail marketing@sick.com.br

**Canada**

Phone +1 905 771 14 44  
E-Mail information@sick.com

**Česká republika**

Phone +420 2 57 91 18 50  
E-Mail sick@sick.cz

**China**

Phone +86 4000 121 000  
E-Mail info.china@sick.net.cn  
Phone +852-2153 6300  
E-Mail ghk@sick.com.hk

**Danmark**

Phone +45 45 82 64 00  
E-Mail sick@sick.dk

**Deutschland**

Phone +49 211 5301-301  
E-Mail info@sick.de

**España**

Phone +34 93 480 31 00  
E-Mail info@sick.es

**France**

Phone +33 1 64 62 35 00  
E-Mail info@sick.fr

**Great Britain**

Phone +44 (0)1727 831121  
E-Mail info@sick.co.uk

**India**

Phone +91-22-4033 8333  
E-Mail info@sick-india.com

**Israel**

Phone +972-4-6881000  
E-Mail info@sick-sensors.com

**Italia**

Phone +39 02 27 43 41  
E-Mail info@sick.it

**Japan**

Phone +81 (0)3 5309 2112  
E-Mail support@sick.jp

**Magyarország**

Phone +36 1 371 2680  
E-Mail office@sick.hu

**Nederland**

Phone +31 (0)30 229 25 44  
E-Mail info@sick.nl

**Norge**

Phone +47 67 81 50 00  
E-Mail sick@sick.no

**Österreich**

Phone +43 (0)22 36 62 28 8-0  
E-Mail office@sick.at

**Polska**

Phone +48 22 837 40 50  
E-Mail info@sick.pl

**România**

Phone +40 356 171 120  
E-Mail office@sick.ro

**Russia**

Phone +7-495-775-05-30  
E-Mail info@sick.ru

**Schweiz**

Phone +41 41 619 29 39  
E-Mail contact@sick.ch

**Singapore**

Phone +65 6744 3732  
E-Mail sales.gsg@sick.com

**Slovenija**

Phone +386 (0)1-47 69 990  
E-Mail office@sick.si

**South Africa**

Phone +27 11 472 3733  
E-Mail info@sickautomation.co.za

**South Korea**

Phone +82 2 786 6321/4  
E-Mail info@sickkorea.net

**Suomi**

Phone +358-9-25 15 800  
E-Mail sick@sick.fi

**Sverige**

Phone +46 10 110 10 00  
E-Mail info@sick.se

**Taiwan**

Phone +886 2 2375-6288  
E-Mail sales@sick.com.tw

**Türkiye**

Phone +90 (216) 528 50 00  
E-Mail info@sick.com.tr

**United Arab Emirates**

Phone +971 (0) 4 88 65 878  
E-Mail info@sick.ae

**USA/México**

Phone +1(952) 941-6780  
1 (800) 325-7425 – tollfree  
E-Mail info@sickusa.com

More representatives and agencies  
at [www.sick.com](http://www.sick.com)