



Photoelectric sensors  
W24-2, Photoelectric proximity sensor,  
Background suppression

WT24-2R548



**Model Name** > [WT24-2R548](#)  
**Part No.** > [1018318](#)



*Illustration may differ*

**At a glance**

- Precise background suppression at ranges up to 2500 mm
- Immune to ambient light and crosstalk from another photoelectric sensor
- Switch selectable PNP or NPN output, Switch selectable Light or Dark operating mode
- Variants with DC voltage and universal AC/DC voltage with UL approval
- Optional test input, adjustable ON and OFF time delays, alarm output and front screen heating also available in high-power version
- M12 or terminal chamber connection: 90° rotatable
- Red light or long-range IR

**Your benefits**

- Metal housing that has been IP 69K tested provides reliability and a long service life
- Immune to ambient light and crosstalk, reducing sensor downtime
- Precise detection at long sensing ranges
- User interface is stored under a durable protection hood to prevent unwanted tampering and protect vital components
- Selectable output type, operating mode, and adjustable time delays makes integration easier and reduce the number of devices needed
- Variants with DC voltage and universal AC/DC voltage provide installation flexibility



**Features**

Sensor/detection principle:	Photoelectric proximity sensor, Background suppression
Dimensions (W x H x D):	27 mm x 87.5 mm x 65 mm
Housing design (light emission):	Rectangular
Sensing range max.:	100 mm ... 1,200 mm <sup>1)</sup>
Sensing range:	100 mm ... 1,200 mm <sup>2)</sup>
Type of light:	Visible red light
Light source:	LED <sup>3)</sup>
Alarm output:	-
Adjustment:	Potentiometer
Light spot size (distance):	Ø 40 mm (1,200 mm)

<sup>1) 2)</sup> Object with 90 % reflectance (referred to standard white, DIN 5033) <sup>3)</sup> Average service life of 100,000 h at T<sub>A</sub> = +25 °C

## Mechanics/electronics

Supply voltage::	12 V DC ... 240 V DC/24 V AC ... 240 V AC <sup>1) 2)</sup>
Power consumption:	< 2 VA
Output type:	Relay, electrically isolated <sup>3)</sup>
Output function:	Change-over contacts
Switching mode:	Light/dark switching <sup>4)</sup>
Switching mode selector:	Selectable via light/dark selector
Switching current (switching voltage):	4 A (24 V DC), 4 A (250 V AC)
Response time:	≤ 10 ms <sup>5)</sup>
Switching frequency:	10 Hz <sup>5)</sup>
Connection type:	Mini connector 7/8", 5-pin <sup>6)</sup>
Circuit protection::	A, C <sup>7) 8)</sup>
Protection class:	II <sup>9)</sup>
Weight:	330 g
Housing material:	Metal, Zinc diecast
Optics material:	PMMA
Enclosure rating:	IP 69K
Usage category:	AC-15, DC-13, According to EN 60947-1
Ambient operating temperature:	-40 °C ... +60 °C
Ambient storage temperature:	-40 °C ... +75 °C

1) Limit values, operation in short-circuit protected network max. 8 A 2) +- 10 % 3) 4) Provide suitable spark suppression for inductive or capacitive loads 5) With light/dark ratio 1:1 6) Connection rotatable by 90° 7) A = V<sub>S</sub> connections reverse-polarity protected 8) C = interference suppression 9) Rated voltage: 250 V AC/DC

## Dimensional drawing

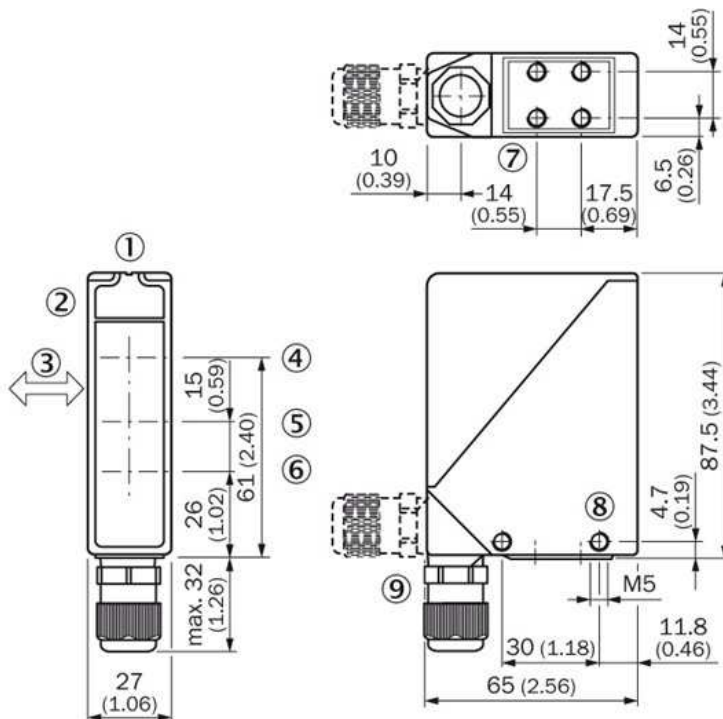

- [1] Alignment sight
- [2] LED signal strength indicator
- [3] Standard direction of the material being detected
- [4] Center of optical axis, sender
- [5] Center of optical axis, receiver (close range)
- [6] Center of optical axis, receiver (far range)
- [7] M5 threaded mounting hole, 6 mm deep
- [8] M5 threaded mounting hole, through-hole
- [9] M16 screw fixing and plug rotatable by 90°

Adjustments possible

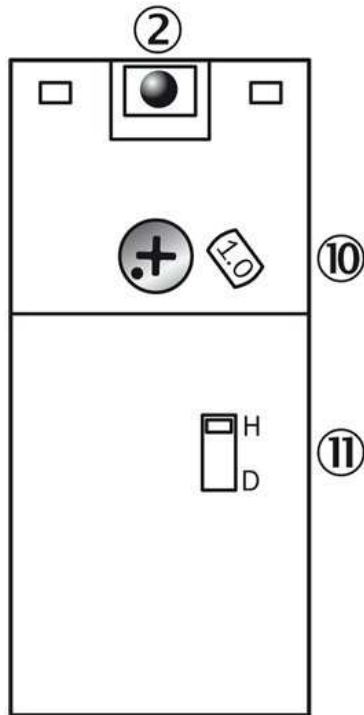

- |2| LED signal strength indicator
- |10| Adjustment sensing range (WT) / sensitivity (WL, WS/WE)
- |11| Light/dark selector

Connection diagram

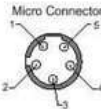
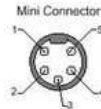
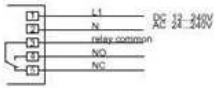

wire colors refer to standard cable, not included

## Characteristic curve

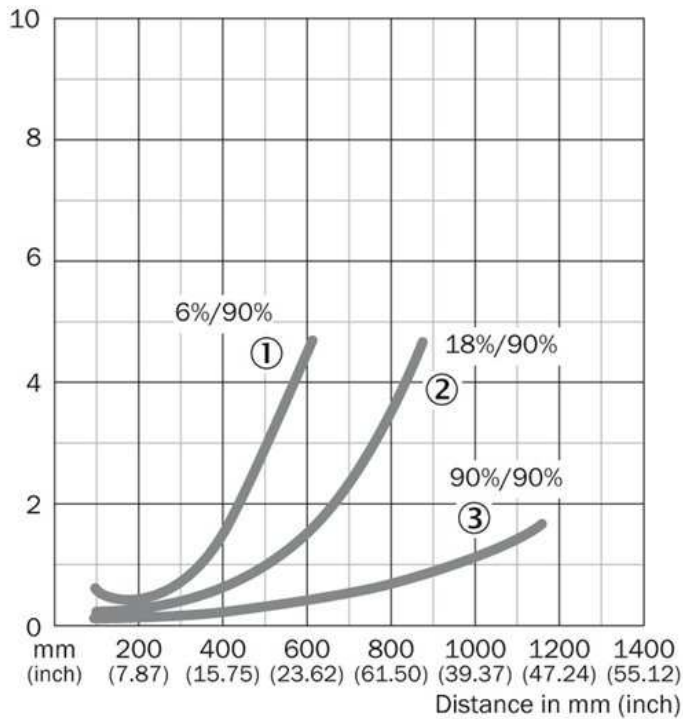

- |1| Sensing range on black, 6 % remission
- |2| Sensing range on gray, 18 % remission
- |3| Sensing range on white, 90 % remission

## Sensing range diagram

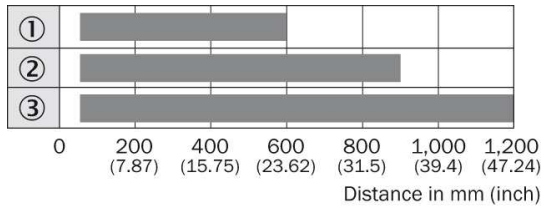

■ Operating distance

- ① Scanning distance on black, 6 % remission
- ② Scanning distance on grey, 18 % remission
- ③ Scanning distance on white, 90 % remission

**Australia**

Phone +61 3 9457 0600  
1800 33 48 02 – tollfree  
E-Mail sales@sick.com.au

**Belgium/Luxembourg**

Phone +32 (0)2 466 55 66  
E-Mail info@sick.be

**Brasil**

Phone +55 11 3215-4900  
E-Mail marketing@sick.com.br

**Canada**

Phone +1 905 771 14 44  
E-Mail information@sick.com

**Česká republika**

Phone +420 2 57 91 18 50  
E-Mail sick@sick.cz

**China**

Phone +86 4000 121 000  
E-Mail info.china@sick.net.cn  
Phone +852-2153 6300  
E-Mail ghk@sick.com.hk

**Danmark**

Phone +45 45 82 64 00  
E-Mail sick@sick.dk

**Deutschland**

Phone +49 211 5301-301  
E-Mail info@sick.de

**España**

Phone +34 93 480 31 00  
E-Mail info@sick.es

**France**

Phone +33 1 64 62 35 00  
E-Mail info@sick.fr

**Great Britain**

Phone +44 (0)1727 831121  
E-Mail info@sick.co.uk

**India**

Phone +91-22-4033 8333  
E-Mail info@sick-india.com

**Israel**

Phone +972-4-6881000  
E-Mail info@sick-sensors.com

**Italia**

Phone +39 02 27 43 41  
E-Mail info@sick.it

**Japan**

Phone +81 (0)3 5309 2112  
E-Mail support@sick.jp

**Magyarország**

Phone +36 1 371 2680  
E-Mail office@sick.hu

**Nederland**

Phone +31 (0)30 229 25 44  
E-Mail info@sick.nl

**Norge**

Phone +47 67 81 50 00  
E-Mail sick@sick.no

**Österreich**

Phone +43 (0)22 36 62 28 8-0  
E-Mail office@sick.at

**Polska**

Phone +48 22 837 40 50  
E-Mail info@sick.pl

**România**

Phone +40 356 171 120  
E-Mail office@sick.ro

**Russia**

Phone +7-495-775-05-30  
E-Mail info@sick.ru

**Schweiz**

Phone +41 41 619 29 39  
E-Mail contact@sick.ch

**Singapore**

Phone +65 6744 3732  
E-Mail sales.gsg@sick.com

**Slovenija**

Phone +386 (0)1-47 69 990  
E-Mail office@sick.si

**South Africa**

Phone +27 11 472 3733  
E-Mail info@sickautomation.co.za

**South Korea**

Phone +82 2 786 6321/4  
E-Mail info@sickkorea.net

**Suomi**

Phone +358-9-25 15 800  
E-Mail sick@sick.fi

**Sverige**

Phone +46 10 110 10 00  
E-Mail info@sick.se

**Taiwan**

Phone +886 2 2375-6288  
E-Mail sales@sick.com.tw

**Türkiye**

Phone +90 (216) 528 50 00  
E-Mail info@sick.com.tr

**United Arab Emirates**

Phone +971 (0) 4 88 65 878  
E-Mail info@sick.ae

**USA/México**

Phone +1(952) 941-6780  
1 (800) 325-7425 – tollfree  
E-Mail info@sickusa.com

More representatives and agencies  
at [www.sick.com](http://www.sick.com)