



## Switching automation light grids ELG, ELG Long Range

ELG3-0450R221



**Model Name** > [ELG3-0450R221](#)

**Part No.** > [1024268](#)



#### At a glance

- Up to 128 beams
- Different beam separations 30 mm and 60 mm
- High functional reserve (gain) for ranges up to 12 m
- Potentiometer for sensitivity setting
- Ambient light up to 150,000 lux
- Tough, aluminum housing
- PNP/NPN/relay output and a test input
- Optical synchronization

#### Your benefits

- Insensitive to ambient light when exposed to direct sunlight, strobe lights, and highly reflective objects, eliminating false trips
- High functional reserve (excess gain) ensures operation even if it gets dirty, dusty, or misaligned, reducing maintenance costs
- Efficient and effective way to combine multiple sensors in one housing with one connector
- Simple commissioning thanks to a larger optical aperture angle and manual fine adjustment option
- Optical synchronization enables quick installation and cost-effective connection
- The sensitivity adjustment can be used to detect or ignore translucent materials to reduce production problems



#### Features

Technology:	Sender/receiver
Task:	Switching light grid
Minimum detectable object (MDO):	Parallel beam: $\geq 35$ mm ... 65 mm
Beam separation:	30 mm
Number of beams:	16
Detection height:	450 mm
Evaluation beams:	Parallel beam

#### Performance

Maximum range:	17 m
Minimum range:	$\geq 0$ mm
Working range:	12 m
Response time <sup>1)</sup> :	Parallel beam 28 ms

1) With resistive load

## Interfaces

---

Output type:	Relais (DC 60 V, AC 25 V)
Connection type:	Leitung 15 m
Test input:	PNP

## Mechanics/electronics

---

Wave length:	880 nm
Supply voltage $V_s$ <sup>1)</sup> :	DC 15 V ... 30 V
Power consumption sender <sup>2)</sup> :	< 100 mA
Power consumption receiver <sup>3)</sup> :	< 100 mA
Ripple:	< 5 Vpp
Output current $I_{max}$ :	100 mA
Output load capacitive:	100 nF
Output load inductive:	1 H
Initialization time:	1 s
Dimensions (W x H x D):	34 mm x 526 mm x 29 mm
Housing material:	Aluminum
Indication:	LED
Enclosure rating:	IP 65
Circuit protection:	Output Q short-circuit protected Interference suppression VS connections reverse-polarity protected
Weight:	1,500 g
Front screen:	PMMA
Output mode <sup>4)</sup> :	Light switching
Switching frequency:	250 kHz
Synchronization:	Optical

1) 2) 3) Typical value <sup>4)</sup> NC = closed in case one beam is interrupted, NO = closed in case all beams are free

## Ambient data

---

Protection class:	III
EMC:	EN 60947-5-2
Ambient temperature:	Operation: -25 ... +55 °C Storage: -40 ... +70 °C
Vibration resistance:	5 g, 10 Hz ... 55 Hz (IEC 68-2-6)
Shock load:	10 g/DIN EN 60068-2-29/16 ms
Ambient light immunity:	Indirect: ≤ 150,000 lx <sup>1)</sup>

<sup>1)</sup> Sunlight

## Dimensional drawing

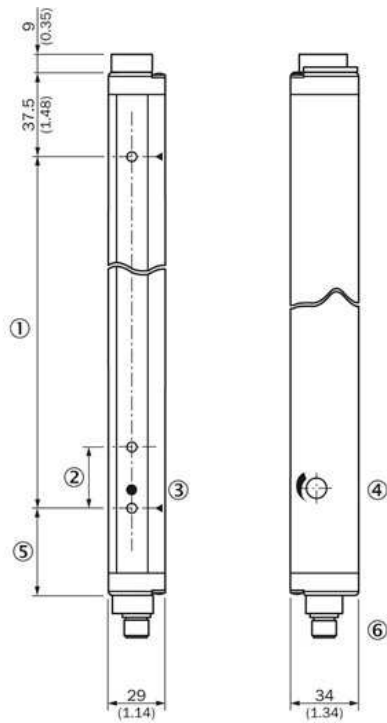

- |1| Detection height
- |2| Beam spacing ELG3: 30 mm / ELG6: 60 mm
- |3| Status indicator (ELGE)/Power on (ELGS)
- |4| Sensitivity adjustment
- |5| Distance to first beam; ELG3: 38.5 mm/ELG6: 68.5 mm
- |6| male connector M12, 5-pin

## LED display receiver

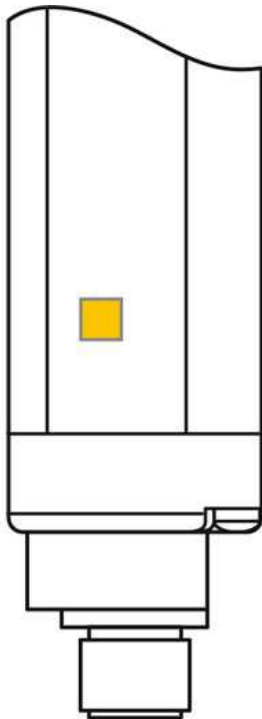

- |1| No object in the light path
- |2| Pollution indication

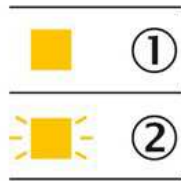

LED display sender

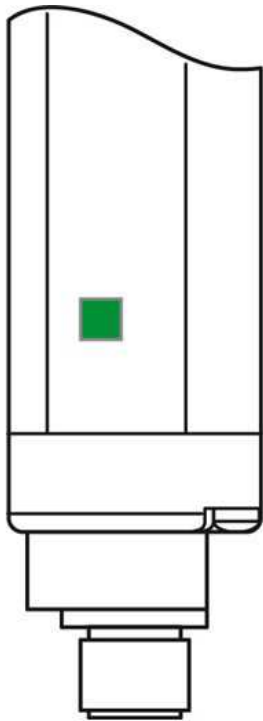

|1| Supply voltage

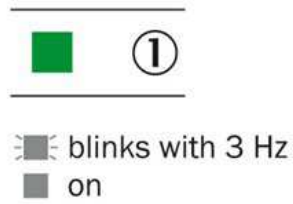

Connection type and diagram

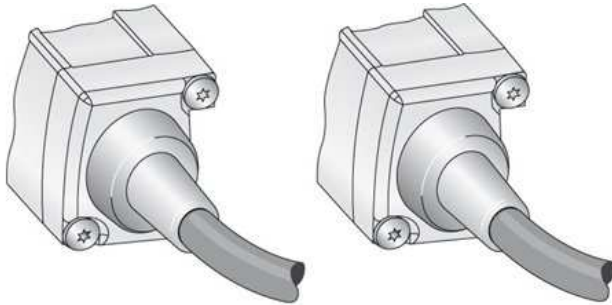

|1| not connected  
|2| change over  
|3| normally open  
|4| normally open

Sender

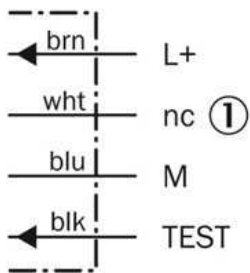

Receiver

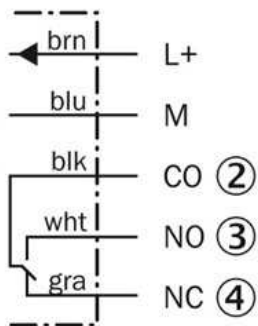

## Connection type and diagram

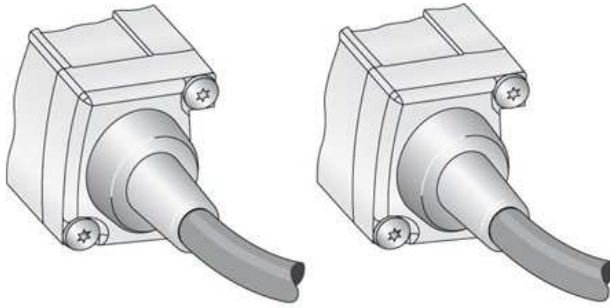

- |1| not connected
- |2| change over
- |3| normally open
- |4| normally open

### Sender

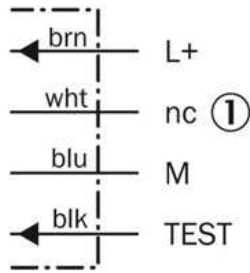

### Receiver

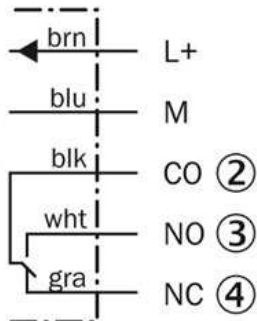

## Special functions

### Sensitivity adjustment

#### 1. Remove cap

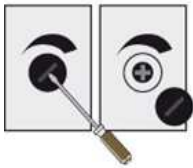

Remove cap with screw driver.

#### 2. Potentiometer adjustment

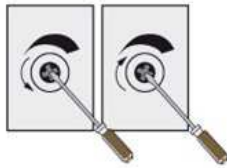

Turn left = for a lower range.  
Turn right = for a higher range.

### Sensitivity adjustment

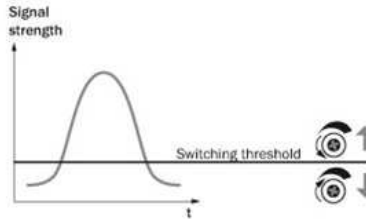

### Optical synchronisation

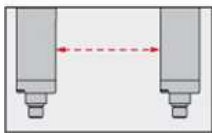

The light grid communicates via the light beams. A cable is not necessary for the optical synchronisation.

**Australia**

Phone +61 3 9457 0600  
1800 33 48 02 – tollfree  
E-Mail sales@sick.com.au

**Belgium/Luxembourg**

Phone +32 (0)2 466 55 66  
E-Mail info@sick.be

**Brasil**

Phone +55 11 3215-4900  
E-Mail marketing@sick.com.br

**Canada**

Phone +1 905 771 14 44  
E-Mail information@sick.com

**Česká republika**

Phone +420 2 57 91 18 50  
E-Mail sick@sick.cz

**China**

Phone +86 4000 121 000  
E-Mail info.china@sick.net.cn  
Phone +852-2153 6300  
E-Mail ghk@sick.com.hk

**Danmark**

Phone +45 45 82 64 00  
E-Mail sick@sick.dk

**Deutschland**

Phone +49 211 5301-301  
E-Mail info@sick.de

**España**

Phone +34 93 480 31 00  
E-Mail info@sick.es

**France**

Phone +33 1 64 62 35 00  
E-Mail info@sick.fr

**Great Britain**

Phone +44 (0)1727 831121  
E-Mail info@sick.co.uk

**India**

Phone +91-22-4033 8333  
E-Mail info@sick-india.com

**Israel**

Phone +972-4-6881000  
E-Mail info@sick-sensors.com

**Italia**

Phone +39 02 27 43 41  
E-Mail info@sick.it

**Japan**

Phone +81 (0)3 5309 2112  
E-Mail support@sick.jp

**Magyarország**

Phone +36 1 371 2680  
E-Mail office@sick.hu

**Nederland**

Phone +31 (0)30 229 25 44  
E-Mail info@sick.nl

**Norge**

Phone +47 67 81 50 00  
E-Mail sick@sick.no

**Österreich**

Phone +43 (0)22 36 62 28 8-0  
E-Mail office@sick.at

**Polska**

Phone +48 22 837 40 50  
E-Mail info@sick.pl

**România**

Phone +40 356 171 120  
E-Mail office@sick.ro

**Russia**

Phone +7-495-775-05-30  
E-Mail info@sick.ru

**Schweiz**

Phone +41 41 619 29 39  
E-Mail contact@sick.ch

**Singapore**

Phone +65 6744 3732  
E-Mail sales.gsg@sick.com

**Slovenija**

Phone +386 (0)1-47 69 990  
E-Mail office@sick.si

**South Africa**

Phone +27 11 472 3733  
E-Mail info@sickautomation.co.za

**South Korea**

Phone +82 2 786 6321/4  
E-Mail info@sickkorea.net

**Suomi**

Phone +358-9-25 15 800  
E-Mail sick@sick.fi

**Sverige**

Phone +46 10 110 10 00  
E-Mail info@sick.se

**Taiwan**

Phone +886 2 2375-6288  
E-Mail sales@sick.com.tw

**Türkiye**

Phone +90 (216) 528 50 00  
E-Mail info@sick.com.tr

**United Arab Emirates**

Phone +971 (0) 4 88 65 878  
E-Mail info@sick.ae

**USA/México**

Phone +1(952) 941-6780  
1 (800) 325-7425 – tollfree  
E-Mail info@sickusa.com

More representatives and agencies  
at [www.sick.com](http://www.sick.com)