



Long range distance sensors DME5000, SSI

DME5000-311



Model Name > [DME5000-311](#)
Part No. > [1025244](#)



At a glance

- Measurement range from 0.15 m to 300 m
- Very fast measurement cycles
- Highest accuracy, repeatability and system availability
- Illuminated LC display with diagnostic information
- Visible red light and bracket with springs for alignment
- Variety of interfaces: SSI, RS-422, PROFIBUS, HIPERFACE, DeviceNet

Your benefits

- Fastest measurement rate offers optimized integration into control loops for increased productivity
- Red laser light as well as adjustable mounting brackets (optional accessory) enable fast and easy alignment, ensuring on-time and cost-effective installation
- Multi-point self checks provide maintenance and replacement warnings increasing overall machine availability
- A tough, metal housing as well as heating and cooling accessories ensure reliability in rough ambient conditions
- User-friendly display with easy-to-use menu along with external PC/PLC programming offers fast and cost-efficient setup
- Multiple serial interfaces provide high-speed position output to the controller and high flexibility in application integration
- Integrated speed monitoring offers additional information for increased process reliability
- Highest degree of accuracy and repeatability ensures high machine availability

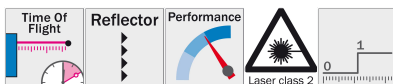

Performance

Measurement range ¹⁾ :	0.15 m ... 300 m, on reflective tape "Diamond Grade"
Resolution:	0.05 mm ... 5 mm
Repeatability ²⁾ , ³⁾ :	2 mm
Accuracy:	± 5 mm
Light source ⁴⁾ :	Laser, red
Typ. light spot size (distance):	130 mm (at 70 m) 270 mm (at 150 m) 360 mm (at 220 m)
Output rate:	1 ms
Max. movement speed:	10 m/s
Laser class:	2 (EN 60825-1/CDRH)

1) 2) On reflective tape "Diamond Grade" 3) Statistical error 1σ , environmental conditions constant, min. warm-up time 10 min 4) Average service life of 50,000 h at $T_A = +25^\circ\text{C}$

Interfaces

Data interface: SSI
Output type ¹⁾: Push-pull: PNP/NPN (100 mA)
Multifunctional input (MF) ^{2), 3)}: 1 x MF

¹⁾ HIGH = $> V_S - 3\text{ V}$ / LOW = $< 2\text{ V}$ ²⁾ HIGH = $> 12\text{ V}$ / LOW = $< 3\text{ V}$ ³⁾ Not reverse-polarity protected

Mechanics/electronics

Supply voltage V_S : DC 18 V ... 30 V, limit values
Ripple ¹⁾: $< 5\text{ Vpp}$
Initialization time ²⁾: 1.5 s
Indication: Display
Weight: Ca. 1,650 g
Output current I_A ³⁾: $\leq 100\text{ mA}$
Power consumption: At 24 V DC $< 250\text{ mA}$
Connection type: Male connector, M16, 8-pin

¹⁾ May not fall short of or exceed V_S tolerances ²⁾ After loss of reflector $< 1\text{ s}$ at max. speed $V_{\text{max}} < 1\text{ m/s}$ ³⁾ Short circuit/overload protected. Max. 100 nF/20 mH

Ambient data

Enclosure rating: IP 65
Protection class ¹⁾: II
Effect of air pressure: 0.3 ppm/hPa
Effect of air temperature: 1 ppm/K
Temperature drift: Typ. 0.1 mm/K
Ambient temperature: Operation: $-10 \dots 55^\circ\text{C}$
Operation with cooling case: $-10 \dots 75^\circ\text{C}$
Storage: $-25 \dots 75^\circ\text{C}$
Mechanical load: Noise: EN 600 68-2-64
Shock: EN 600 68-2-27 / -2-29
Sine: EN 600 68-2-6
Electromagnetic compatibility (EMC): EN 61000-6-2, EN 55011

¹⁾ Reference voltage DC 32 V

Dimensional drawing

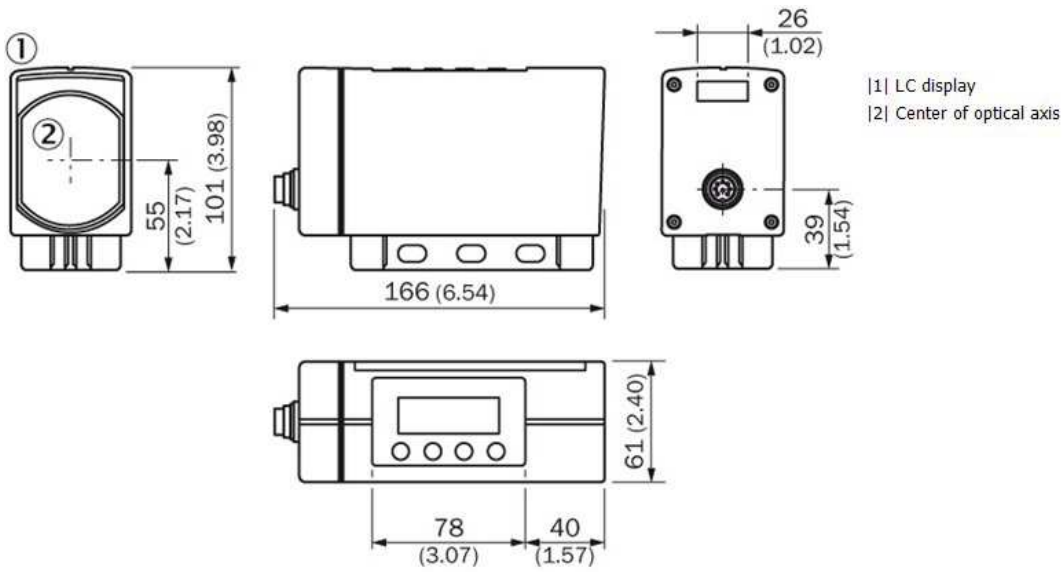

All dimensions in mm (inch)

Adjustments

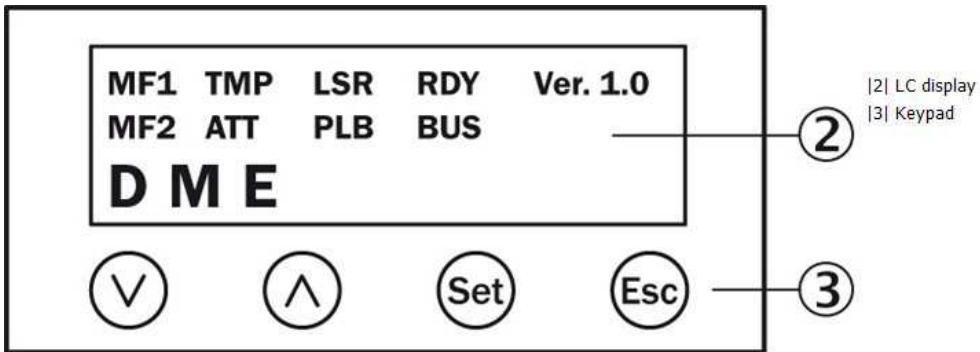

Connection type



Connection diagram

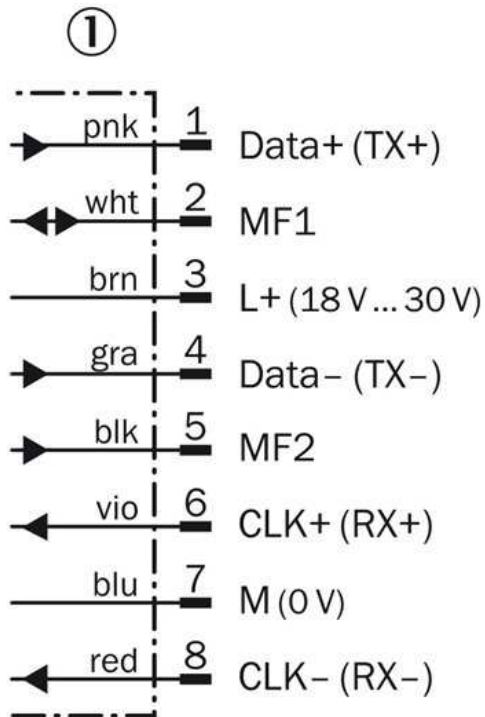

[1] Connector M16, 8-pin

Australia

Phone +61 3 9457 0600
1800 33 48 02 – tollfree
E-Mail sales@sick.com.au

Belgium/Luxembourg

Phone +32 (0)2 466 55 66
E-Mail info@sick.be

Brasil

Phone +55 11 3215-4900
E-Mail marketing@sick.com.br

Canada

Phone +1 905 771 14 44
E-Mail information@sick.com

Česká republika

Phone +420 2 57 91 18 50
E-Mail sick@sick.cz

China

Phone +86 4000 121 000
E-Mail info.china@sick.net.cn
Phone +852-2153 6300
E-Mail ghk@sick.com.hk

Danmark

Phone +45 45 82 64 00
E-Mail sick@sick.dk

Deutschland

Phone +49 211 5301-301
E-Mail info@sick.de

España

Phone +34 93 480 31 00
E-Mail info@sick.es

France

Phone +33 1 64 62 35 00
E-Mail info@sick.fr

Great Britain

Phone +44 (0)1727 831121
E-Mail info@sick.co.uk

India

Phone +91-22-4033 8333
E-Mail info@sick-india.com

Israel

Phone +972-4-6881000
E-Mail info@sick-sensors.com

Italia

Phone +39 02 27 43 41
E-Mail info@sick.it

Japan

Phone +81 (0)3 5309 2112
E-Mail support@sick.jp

Magyarország

Phone +36 1 371 2680
E-Mail office@sick.hu

Nederland

Phone +31 (0)30 229 25 44
E-Mail info@sick.nl

Norge

Phone +47 67 81 50 00
E-Mail sick@sick.no

Österreich

Phone +43 (0)22 36 62 28 8-0
E-Mail office@sick.at

Polska

Phone +48 22 837 40 50
E-Mail info@sick.pl

România

Phone +40 356 171 120
E-Mail office@sick.ro

Russia

Phone +7-495-775-05-30
E-Mail info@sick.ru

Schweiz

Phone +41 41 619 29 39
E-Mail contact@sick.ch

Singapore

Phone +65 6744 3732
E-Mail sales.gsg@sick.com

Slovenija

Phone +386 (0)1-47 69 990
E-Mail office@sick.si

South Africa

Phone +27 11 472 3733
E-Mail info@sickautomation.co.za

South Korea

Phone +82 2 786 6321/4
E-Mail info@sickkorea.net

Suomi

Phone +358-9-25 15 800
E-Mail sick@sick.fi

Sverige

Phone +46 10 110 10 00
E-Mail info@sick.se

Taiwan

Phone +886 2 2375-6288
E-Mail sales@sick.com.tw

Türkiye

Phone +90 (216) 528 50 00
E-Mail info@sick.com.tr

United Arab Emirates

Phone +971 (0) 4 88 65 878
E-Mail info@sick.ae

USA/México

Phone +1(952) 941-6780
1 (800) 325-7425 – tollfree
E-Mail info@sickusa.com

More representatives and agencies
at www.sick.com