



## Long range distance sensors DME5000, RS-422

DME5000-323



**Model Name** > [DME5000-323](#)  
**Part No.** > [1025253](#)



**At a glance**

- Measurement range from 0.15 m to 300 m
- Very fast measurement cycles
- Highest accuracy, repeatability and system availability
- Illuminated LC display with diagnostic information
- Visible red light and bracket with springs for alignment
- Variety of interfaces: SSI, RS-422, PROFIBUS, HIPERFACE, DeviceNet

**Your benefits**

- Fastest measurement rate offers optimized integration into control loops for increased productivity
- Red laser light as well as adjustable mounting brackets (optional accessory) enable fast and easy alignment, ensuring on-time and cost-effective installation
- Multi-point self checks provide maintenance and replacement warnings increasing overall machine availability
- A tough, metal housing as well as heating and cooling accessories ensure reliability in rough ambient conditions
- User-friendly display with easy-to-use menu along with external PC/PLC programming offers fast and cost-efficient setup
- Multiple serial interfaces provide high-speed position output to the controller and high flexibility in application integration
- Integrated speed monitoring offers additional information for increased process reliability
- Highest degree of accuracy and repeatability ensures high machine availability

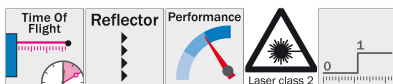

CE  **CDRH RS-422**

**Performance**

Measurement range <sup>1)</sup> :	0.15 m ... 300 m, on reflective tape "Diamond Grade"
Resolution:	0.05 mm ... 5 mm
Repeatability <sup>2)</sup> , <sup>3)</sup> :	2 mm
Accuracy:	± 5 mm
Light source <sup>4)</sup> :	Laser, red
Typ. light spot size (distance):	130 mm (at 70 m) 270 mm (at 150 m) 360 mm (at 220 m)
Output rate:	2 ms
Max. movement speed:	10 m/s
Laser class:	2 (EN 60825-1/CDRH)

1) 2) On reflective tape "Diamond Grade" 3) Statistical error  $1 \sigma$ , environmental conditions constant, min. warm-up time 10 min 4) Average service life of 50,000 h at  $T_A = +25^\circ\text{C}$

## Interfaces

---

Data interface: RS-422  
Output type <sup>1)</sup>: Push-pull: PNP/NPN (100 mA)  
Multifunctional input (MF) <sup>2)</sup>, <sup>3)</sup>: 1 x MF

<sup>1)</sup> HIGH =  $> V_S - 3\text{ V}$  / LOW =  $< 2\text{ V}$  <sup>2)</sup> HIGH =  $> 12\text{ V}$  / LOW =  $< 3\text{ V}$  <sup>3)</sup> Not reverse-polarity protected

## Mechanics/electronics

---

Supply voltage  $V_S$ : DC 18 V ... 30 V, limit values  
Ripple <sup>1)</sup>:  $< 5\text{ Vpp}$   
Initialization time <sup>2)</sup>: 1.5 s  
Indication: Display  
Weight: Ca. 1,650 g  
Output current  $I_A$  <sup>3)</sup>:  $\leq 100\text{ mA}$   
Power consumption: At 24 V DC  $< 1,000\text{ mA}$   
Connection type: Male connector, M16, 8-pin

<sup>1)</sup> May not fall short of or exceed  $V_S$  tolerances <sup>2)</sup> After loss of reflector  $< 1\text{ s}$  at max. speed  $V_{\text{max}} < 1\text{ m/s}$  <sup>3)</sup> Short circuit/overload protected. Max. 100 nF/20 mH

## Ambient data

---

Enclosure rating: IP 65  
Protection class <sup>1)</sup>: II  
Effect of air pressure: 0.3 ppm/hPa  
Effect of air temperature: 1 ppm/K  
Temperature drift: Typ. 0.1 mm/K  
Ambient temperature: Operation with heating:  $-40 \dots 55^\circ\text{C}$   
Operation with cooling case:  $-40 \dots 75^\circ\text{C}$   
Storage:  $-25 \dots 75^\circ\text{C}$   
Mechanical load: Noise: EN 600 68-2-64  
Shock: EN 600 68-2-27 / -2-29  
Sine: EN 600 68-2-6  
Electromagnetic compatibility (EMC): EN 61000-6-2, EN 55011

<sup>1)</sup> Reference voltage DC 32 V

## Dimensional drawing

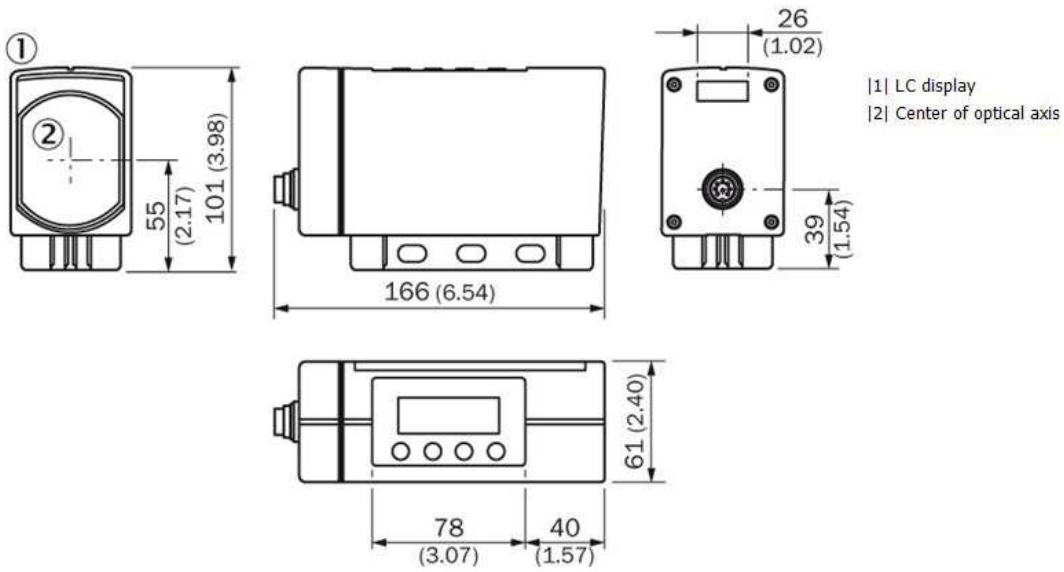

All dimensions in mm (inch)

## Adjustments

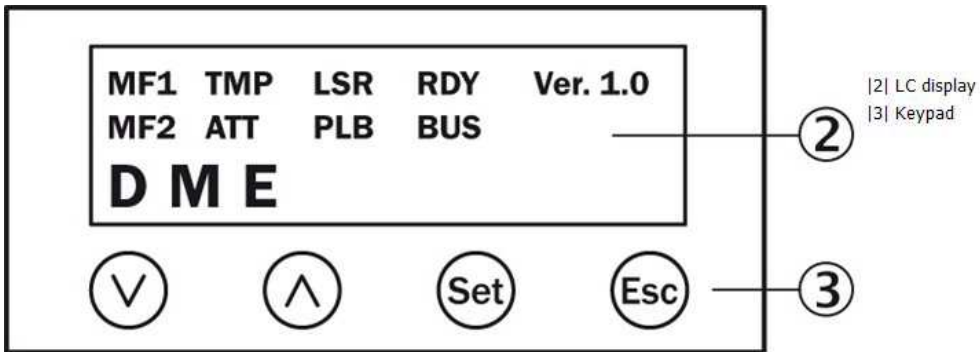

## Connection type



## Connection diagram

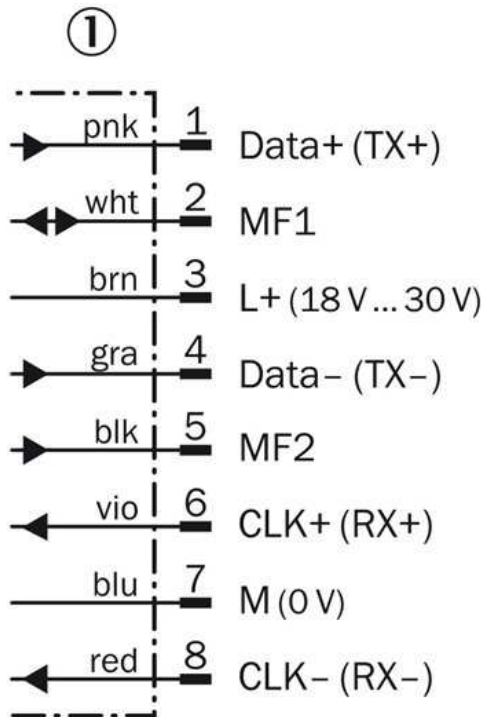

[1] Connector M16, 8-pin

**Australia**

Phone +61 3 9457 0600  
1800 33 48 02 – tollfree  
E-Mail sales@sick.com.au

**Belgium/Luxembourg**

Phone +32 (0)2 466 55 66  
E-Mail info@sick.be

**Brasil**

Phone +55 11 3215-4900  
E-Mail marketing@sick.com.br

**Canada**

Phone +1 905 771 14 44  
E-Mail information@sick.com

**Česká republika**

Phone +420 2 57 91 18 50  
E-Mail sick@sick.cz

**China**

Phone +86 4000 121 000  
E-Mail info.china@sick.net.cn  
Phone +852-2153 6300  
E-Mail ghk@sick.com.hk

**Danmark**

Phone +45 45 82 64 00  
E-Mail sick@sick.dk

**Deutschland**

Phone +49 211 5301-301  
E-Mail info@sick.de

**España**

Phone +34 93 480 31 00  
E-Mail info@sick.es

**France**

Phone +33 1 64 62 35 00  
E-Mail info@sick.fr

**Great Britain**

Phone +44 (0)1727 831121  
E-Mail info@sick.co.uk

**India**

Phone +91-22-4033 8333  
E-Mail info@sick-india.com

**Israel**

Phone +972-4-6881000  
E-Mail info@sick-sensors.com

**Italia**

Phone +39 02 27 43 41  
E-Mail info@sick.it

**Japan**

Phone +81 (0)3 5309 2112  
E-Mail support@sick.jp

**Magyarország**

Phone +36 1 371 2680  
E-Mail office@sick.hu

**Nederland**

Phone +31 (0)30 229 25 44  
E-Mail info@sick.nl

**Norge**

Phone +47 67 81 50 00  
E-Mail sick@sick.no

**Österreich**

Phone +43 (0)22 36 62 28 8-0  
E-Mail office@sick.at

**Polska**

Phone +48 22 837 40 50  
E-Mail info@sick.pl

**România**

Phone +40 356 171 120  
E-Mail office@sick.ro

**Russia**

Phone +7-495-775-05-30  
E-Mail info@sick.ru

**Schweiz**

Phone +41 41 619 29 39  
E-Mail contact@sick.ch

**Singapore**

Phone +65 6744 3732  
E-Mail sales.gsg@sick.com

**Slovenija**

Phone +386 (0)1-47 69 990  
E-Mail office@sick.si

**South Africa**

Phone +27 11 472 3733  
E-Mail info@sickautomation.co.za

**South Korea**

Phone +82 2 786 6321/4  
E-Mail info@sickkorea.net

**Suomi**

Phone +358-9-25 15 800  
E-Mail sick@sick.fi

**Sverige**

Phone +46 10 110 10 00  
E-Mail info@sick.se

**Taiwan**

Phone +886 2 2375-6288  
E-Mail sales@sick.com.tw

**Türkiye**

Phone +90 (216) 528 50 00  
E-Mail info@sick.com.tr

**United Arab Emirates**

Phone +971 (0) 4 88 65 878  
E-Mail info@sick.ae

**USA/México**

Phone +1(952) 941-6780  
1 (800) 325-7425 – tollfree  
E-Mail info@sickusa.com

More representatives and agencies  
at [www.sick.com](http://www.sick.com)