



Measuring automation light grids MLG, MLG Programmable

MLG5-1750F212



Model Name > [MLG5-1750F212](#)
Part No. > [1025327](#)



At a glance

- Resolutions of 10 / 20 / 30 / 50 mm and customer-specific resolutions
- Working range up to 8.5 m
- Detection heights of over 3 m and up to 240 beams possible
- Short response time
- External teach-in for optimal sensitivity settings
- Easy-to-use setup software for customized application

Your benefits

- Intelligent evaluation software saves costs by quickly and easily turning a standard sensor into a custom problem solver, reducing the number of sensors, PLCs and programming required
- Easy-to-see status information helps avoid interrupting operation
- Different beam separation options, detection heights and output configurations ensure a reliable solution
- 6 discrete outputs for custom solutions
- Robust metal housing stands up to tough environments and reduces downtime



Features

Technology:	Sender/receiver
Task:	Measurement light grid
Minimum detectable object (MDO) ¹⁾ :	Parallel beam: ≥55 mm
Beam separation:	50 mm
Number of beams:	36
Detection height:	1,750 mm
Configuration:	Parameterization interface (measuring)

¹⁾ MDO min. detectable object

Performance

Maximum range ¹⁾ :	7 m
Minimum range:	Parallel beam: ≥0 mm
Response time ²⁾ :	Parallel beam: ≥6.4 ms
Working range ³⁾ :	5 m

¹⁾ No reserve for environmental issue and deterioration of the diode ²⁾ With resistive load ³⁾ Aperture ± 3°

Interfaces

Output type:	6 x PNP
Inputs:	2 x PNP
Connection type:	Terminals

Mechanics/electronics

Wave length:	IR 880 nm
Supply voltage V_s ¹⁾ :	DC 18 V ... 30 V
Power consumption sender ²⁾ :	212 mA
Power consumption receiver ³⁾ :	208 mA
Ripple:	< 5 Vpp
Output current $I_{max.}$:	100 mA
Output load capacitive:	100 nF
Output load inductive:	1 H
Initialization time:	1 s
Dimensions (W x H x D):	34 mm x 1,975 mm x 29 mm
Housing material:	Aluminum
Indication:	7-segment display, LED
Synchronization:	Cable
Enclosure rating:	IP 65
Circuit protection:	Output Q short-circuit protected, Interference suppression, VS connections reverse-polarity protected
Weight:	4.525 kg
Power consumption:	212 mA ⁴⁾
Front screen:	PMMA

1) Without load ^{2) 3) 4)} Without load with 24 V

Ambient data

Protection class:	III
EMC:	EN 60947-5-2
Ambient temperature:	Operation: -25 ... +55 °C, Storage: -40 ... +70 °C
Ambient light safety ^{1), 2)} :	Direct: $\geq 12,500$ lx, Indirect: $\geq 50,000$ lx
Vibration resistance:	5 g, 10 Hz ... 55 Hz (IEC 68-2-6)
Shock load:	10 g/IEC 68-2-29/16 ms

1) 2) Sunlight

Dimensional drawing



	A	B
	Distance: MLG edge - first beam	
Beam separation MLG1 10 mm	49 (1.93)	160 (6.30)
Beam separation MLG2 20 mm	49 (1.93) ¹⁾	170 (6.69)
Beam separation MLG3 30 mm	69 (2.72)	180 (7.09)
Beam separation MLG5 50 mm	89 (3.50)	200 (7.87)

¹⁾ With even number of beams.
²⁾ With odd number of beams.

- |1| Detection height (see optical performance)
- |2| Beam separation (10, 20, 30, 50 mm)
- |3| Status indicator: LEDs green, yellow, red
- |4| Indicator panel, 7-segment display
- |5| Terminals: M16 cable entry/connector M12, 12-pin
- |6| Configuration connector M8, 4-pin

Adjustments receiver



- ☉ blinks with 3 Hz
- on
- out
- ◐ on or out

- |1| Supply voltage
- |2| Device error
- |3| No object in the light path
- |4| Pollution indication
- |5| Blocked Beams Hold (BBH)
- |6| Activated teach-in procedure
- |7| ParamMode is active
- |8| standby
- |9| Error: E1 = sync. error; E2 = less receiver signal; E9 = defect

Connection type and diagram

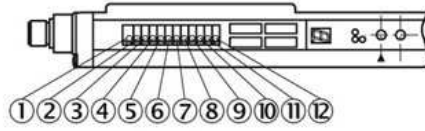

|1| not connected

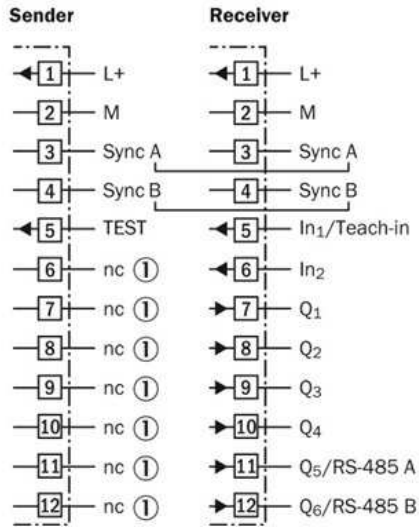

Australia

Phone +61 3 9457 0600
1800 33 48 02 – tollfree
E-Mail sales@sick.com.au

Belgium/Luxembourg

Phone +32 (0)2 466 55 66
E-Mail info@sick.be

Brasil

Phone +55 11 3215-4900
E-Mail marketing@sick.com.br

Canada

Phone +1 905 771 14 44
E-Mail information@sick.com

Česká republika

Phone +420 2 57 91 18 50
E-Mail sick@sick.cz

China

Phone +86 4000 121 000
E-Mail info.china@sick.net.cn
Phone +852-2153 6300
E-Mail ghk@sick.com.hk

Danmark

Phone +45 45 82 64 00
E-Mail sick@sick.dk

Deutschland

Phone +49 211 5301-301
E-Mail info@sick.de

España

Phone +34 93 480 31 00
E-Mail info@sick.es

France

Phone +33 1 64 62 35 00
E-Mail info@sick.fr

Great Britain

Phone +44 (0)1727 831121
E-Mail info@sick.co.uk

India

Phone +91-22-4033 8333
E-Mail info@sick-india.com

Israel

Phone +972-4-6881000
E-Mail info@sick-sensors.com

Italia

Phone +39 02 27 43 41
E-Mail info@sick.it

Japan

Phone +81 (0)3 5309 2112
E-Mail support@sick.jp

Magyarország

Phone +36 1 371 2680
E-Mail office@sick.hu

Nederland

Phone +31 (0)30 229 25 44
E-Mail info@sick.nl

Norge

Phone +47 67 81 50 00
E-Mail sick@sick.no

Österreich

Phone +43 (0)22 36 62 28 8-0
E-Mail office@sick.at

Polska

Phone +48 22 837 40 50
E-Mail info@sick.pl

România

Phone +40 356 171 120
E-Mail office@sick.ro

Russia

Phone +7-495-775-05-30
E-Mail info@sick.ru

Schweiz

Phone +41 41 619 29 39
E-Mail contact@sick.ch

Singapore

Phone +65 6744 3732
E-Mail sales.gsg@sick.com

Slovenija

Phone +386 (0)1-47 69 990
E-Mail office@sick.si

South Africa

Phone +27 11 472 3733
E-Mail info@sickautomation.co.za

South Korea

Phone +82 2 786 6321/4
E-Mail info@sickkorea.net

Suomi

Phone +358-9-25 15 800
E-Mail sick@sick.fi

Sverige

Phone +46 10 110 10 00
E-Mail info@sick.se

Taiwan

Phone +886 2 2375-6288
E-Mail sales@sick.com.tw

Türkiye

Phone +90 (216) 528 50 00
E-Mail info@sick.com.tr

United Arab Emirates

Phone +971 (0) 4 88 65 878
E-Mail info@sick.ae

USA/México

Phone +1(952) 941-6780
1 (800) 325-7425 – tollfree
E-Mail info@sickusa.com

More representatives and agencies
at www.sick.com