



Photoelectric sensors
W4-3, Photoelectric retro-reflective sensor,
Standard optics

WL4-3P3130



Model Name > [WL4-3P3130](#)
Part No. > [1028144](#)



Illustration may differ

At a glance

- Fixed setting or setting via teach-in pushbutton
- PinPoint LED technology for highly visible, intense light spot
- Sensing range from 0.01 - 4 m
- Rugged plastic housing with M3 threaded metal inserts

Your benefits

- The PinPoint LED's sharply defined, intense light spot simplifies alignment
- Low-cost machine integration due to small dimensions that enable mounting in areas with tight space restrictions
- Rugged mounting system with M3 threaded metal inserts reduces maintenance costs due to a long service life



Features

Sensor/detection principle:	Photoelectric retro-reflective sensor, Standard optics
Dimensions (W x H x D):	16 mm x 39.5 mm x 12 mm
Housing design (light emission):	Rectangular
Sensing range max.:	0.01 m ... 4.5 m ¹⁾
Sensing range:	0.02 m ... 3.5 m ²⁾
Type of light:	Visible red light
Light source:	PinPoint LED ³⁾
Wave length:	650 nm
Light spot size (distance):	Ø 75 mm (1.5 m)

^{1) 2)} PL80A ³⁾ Average service life of 100,000 h at T_A = +25 °C

Mechanics/electronics

Supply voltage:	10 V DC ... 30 V DC ¹⁾
Ripple::	< 5 Vpp ^{2) 3)}
Power consumption:	≤ 20 mA ⁴⁾
Output type:	PNP
Switching mode:	Light switching
Output current I _{max} ::	≤ 100 mA
Response time:	< 0.5 ms ⁵⁾
Switching frequency:	1,000 Hz ⁶⁾
Connection type:	Cable with connector M8, 3-pin, 100 mm ⁷⁾
Cable material:	PVC

Conductor cross-section:	0.14 mm ²
Cable diameter:	3.4 mm
Circuit protection:::	A, C, D ^{8) 9) 10)}
Protection class:	III
Weight:	30 g
Polarisation filter:	✓
Optics material:	PMMA
Enclosure rating:	IP 67 IP 66
Ambient operating temperature:	-40 °C ... +60 °C
Ambient storage temperature:	-40 °C ... +75 °C
UL File No.:	NRKH.E181493 & NRKH7.E181493
Housing material:	ABS, Plastic

1) Limit values 2) 3) May not exceed or fall short of V_S tolerances 4) Without load 5) Signal transit time with resistive load 6) With light/dark ratio 1:1 7) Do not bend below 0 °C 8) A = V_S connections reverse-polarity protected 9) C = interference suppression 10) D = outputs overcurrent and short-circuit protected

Dimensional drawing

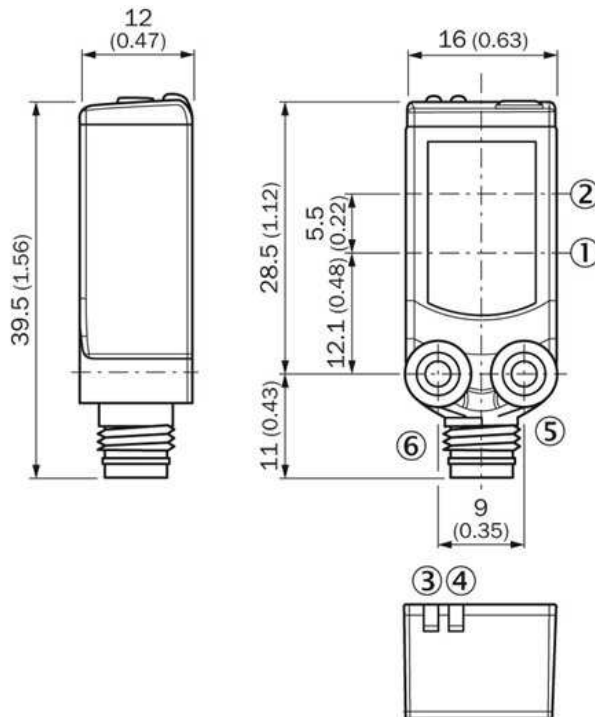

- |1| Center of optical axis, sender
- |2| Center of optical axis, receiver
- |3| LED indicator orange: status of received light beam
- |4| Status indicator LED green: supply voltage on
- |5| Threaded mounting hole M3
- |6| Connection

Connection diagram



Characteristic curve

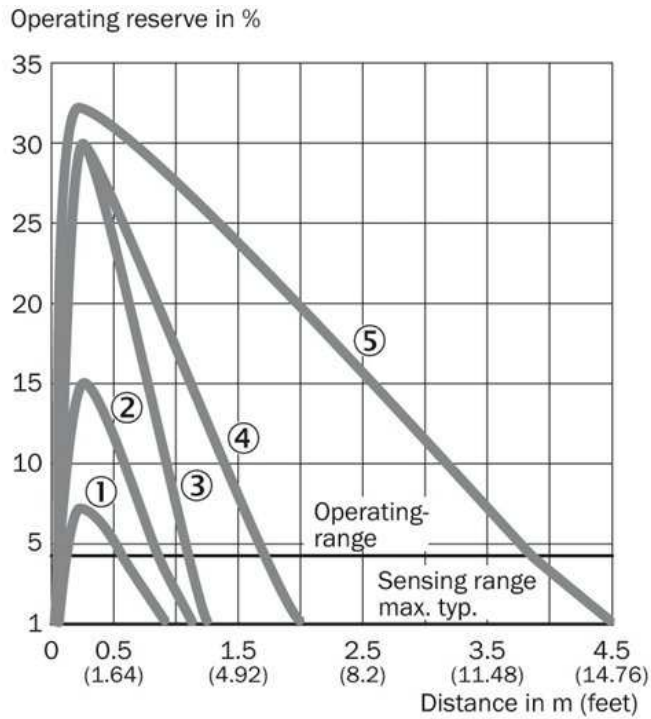

- |1| REF-IRF-56
- |2| PL10F
- |3| PL20A
- |4| PL40A
- |5| PL80A

Sensing range diagram

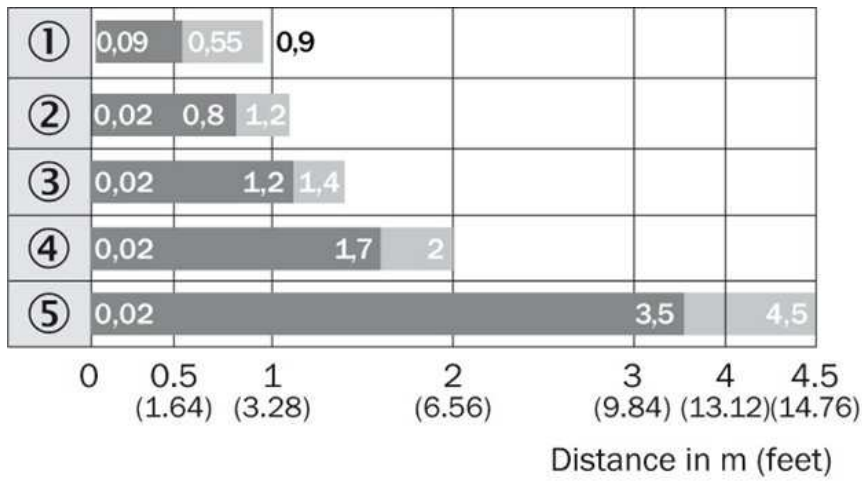

- |1| REF-IRF-56
- |2| PL10F
- |3| PL20A
- |4| PL40A
- |5| PL80A

■ Sensing range ■ Sensing range max.

Connection type



Australia

Phone +61 3 9457 0600
1800 33 48 02 – tollfree
E-Mail sales@sick.com.au

Belgium/Luxembourg

Phone +32 (0)2 466 55 66
E-Mail info@sick.be

Brasil

Phone +55 11 3215-4900
E-Mail marketing@sick.com.br

Canada

Phone +1 905 771 14 44
E-Mail information@sick.com

Česká republika

Phone +420 2 57 91 18 50
E-Mail sick@sick.cz

China

Phone +86 4000 121 000
E-Mail info.china@sick.net.cn
Phone +852-2153 6300
E-Mail ghk@sick.com.hk

Danmark

Phone +45 45 82 64 00
E-Mail sick@sick.dk

Deutschland

Phone +49 211 5301-301
E-Mail info@sick.de

España

Phone +34 93 480 31 00
E-Mail info@sick.es

France

Phone +33 1 64 62 35 00
E-Mail info@sick.fr

Great Britain

Phone +44 (0)1727 831121
E-Mail info@sick.co.uk

India

Phone +91-22-4033 8333
E-Mail info@sick-india.com

Israel

Phone +972-4-6881000
E-Mail info@sick-sensors.com

Italia

Phone +39 02 27 43 41
E-Mail info@sick.it

Japan

Phone +81 (0)3 5309 2112
E-Mail support@sick.jp

Magyarország

Phone +36 1 371 2680
E-Mail office@sick.hu

Nederland

Phone +31 (0)30 229 25 44
E-Mail info@sick.nl

Norge

Phone +47 67 81 50 00
E-Mail sick@sick.no

Österreich

Phone +43 (0)22 36 62 28 8-0
E-Mail office@sick.at

Polska

Phone +48 22 837 40 50
E-Mail info@sick.pl

România

Phone +40 356 171 120
E-Mail office@sick.ro

Russia

Phone +7-495-775-05-30
E-Mail info@sick.ru

Schweiz

Phone +41 41 619 29 39
E-Mail contact@sick.ch

Singapore

Phone +65 6744 3732
E-Mail sales.gsg@sick.com

Slovenija

Phone +386 (0)1-47 69 990
E-Mail office@sick.si

South Africa

Phone +27 11 472 3733
E-Mail info@sickautomation.co.za

South Korea

Phone +82 2 786 6321/4
E-Mail info@sickkorea.net

Suomi

Phone +358-9-25 15 800
E-Mail sick@sick.fi

Sverige

Phone +46 10 110 10 00
E-Mail info@sick.se

Taiwan

Phone +886 2 2375-6288
E-Mail sales@sick.com.tw

Türkiye

Phone +90 (216) 528 50 00
E-Mail info@sick.com.tr

United Arab Emirates

Phone +971 (0) 4 88 65 878
E-Mail info@sick.ae

USA/México

Phone +1(952) 941-6780
1 (800) 325-7425 – tollfree
E-Mail info@sickusa.com

More representatives and agencies
at www.sick.com