



2D vision
CVS, CVS4, CVS4

CVS4-N150



Model Name > CVS4-N150
Part No. > 1028678



At a glance

- Color inspection and sorting on large fields of view
- Inspecting one color, minimum and maximum fill
- 2-color matching
- Sorting up to 15 colors
- Reference capacity of 15 color configurations
- Parameter up- and download to PC
- Compact IP-67 rated housing with integrated display for configuration and monitoring
- Different variants for different fields of view and working distances

Your benefits

- The support for large fields of view ensures reliable color sorting even if your part varies in position
- The minimum and maximum fill tolerance ensures you that there is always correct fill of color on your part before it leaves your line
- The 2-color matching ensures you reliable result on multi- colored objects
- The reference capacity of 15 color configurations gives you the most economic solution for batch production
- Store and restore the configuration from PC will save you time in every repetitive machine installation



Features

Task:	Inspection
Technology:	2D Image analysis Snapshot
Toolset:	OCR OCV
Sensing distance:	44 mm ... 56 mm
Spectral range:	Ca. 400 nm ... 750 nm
LED class:	Risk group 1 (low risk, IEC62471 : 2006)
Offline support:	Configuration
Sensor resolution:	512 x 242
Internal lighting:	White
Character height:	1.1 mm ... 24 mm

Performance

Maximum performance:	43 fps
Typical performance:	20 fps
Number of inspections:	4
Character width:	1 mm ... 11 mm

Interfaces

Operator interfaces:	External display or integrated display
Digital inputs:	HIGH (corresp. 8 V)
Configurable inputs:	Reference object selection String input Encoder input External trigger External teach
Digital outputs:	NPN
Configurable outputs:	Control of external light, Auxiliary
Output current:	< 100 mA
Default outputs:	Inspection passed
Maximum encoder frequency:	2 kHz
Serial (RS-232):	1
Ethernet:	-
Configuration software:	CVS device software, CVS4 Dataloader (PC)

Mechanics/electronics

Connectors:	HRS, 6-pin (external lighting/monitor) Cable, 8-wire, 2 m (I/O, power)
Power consumption:	< 140 mA Without output load (at 24 V)
Ripple:	< 5 Vpp
Enclosure rating:	IP 67
Housing material:	ABS, Acryl glass, Polycarbonate
Dimensions (L x W x H):	95 mm x 42 mm x 34 mm
Weight:	200 g

Ambient data

Ambient operating temperature ¹⁾ :	0 °C ... +40 °C
Ambient storage temperature ²⁾ :	-20 °C ... +70 °C

1) 2) Relative humidity: 35 % ... 85 %, 95 % at storage

Dimensional drawing

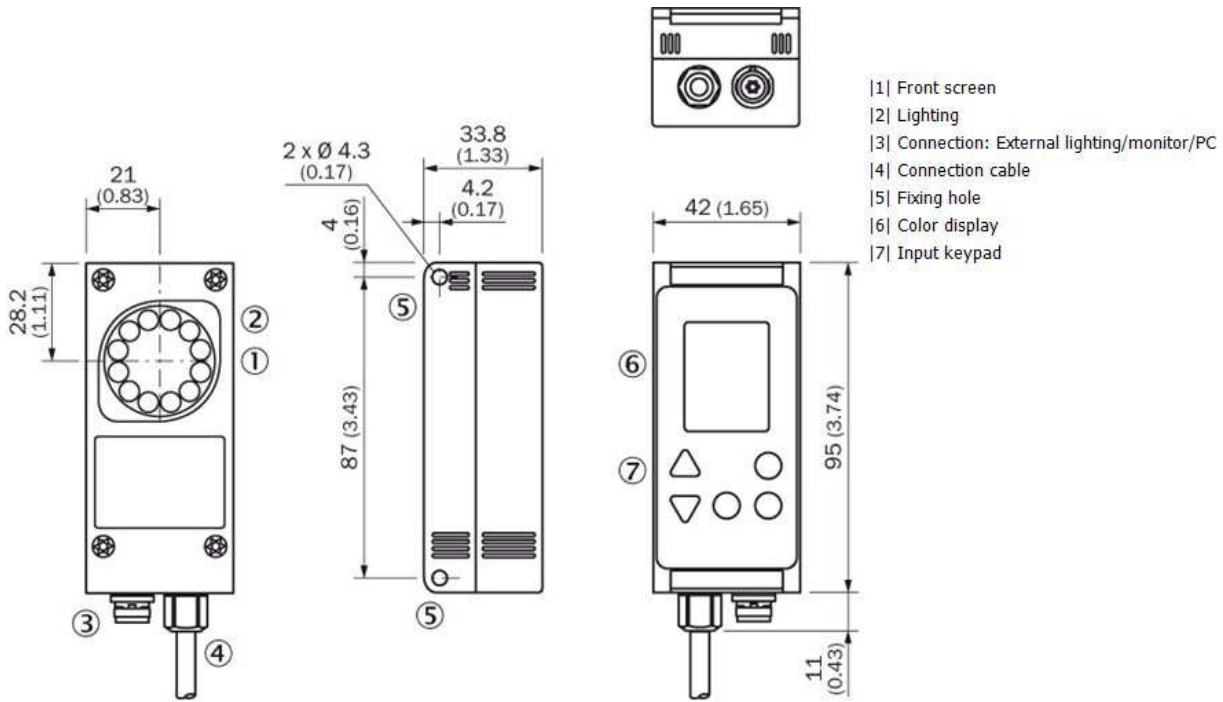

Adjustment possible

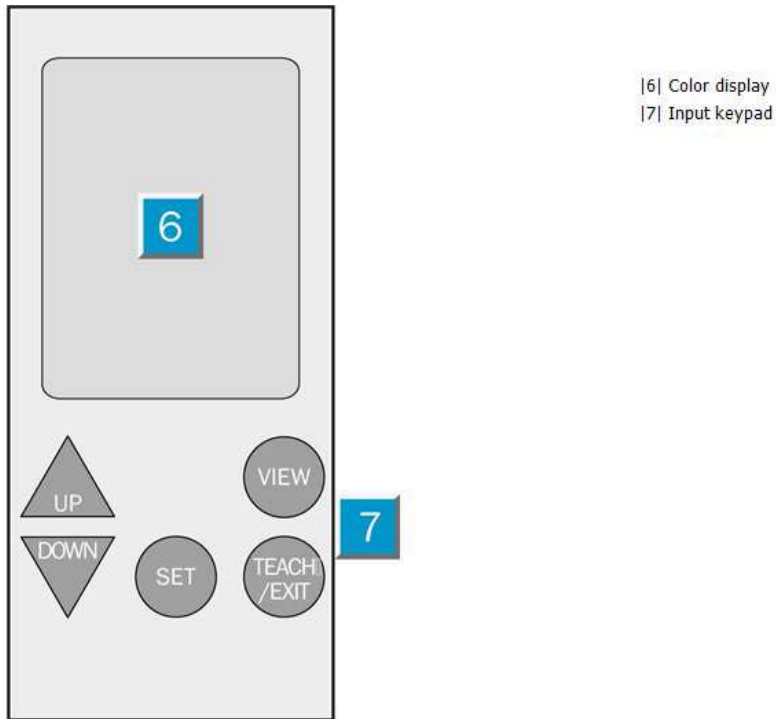

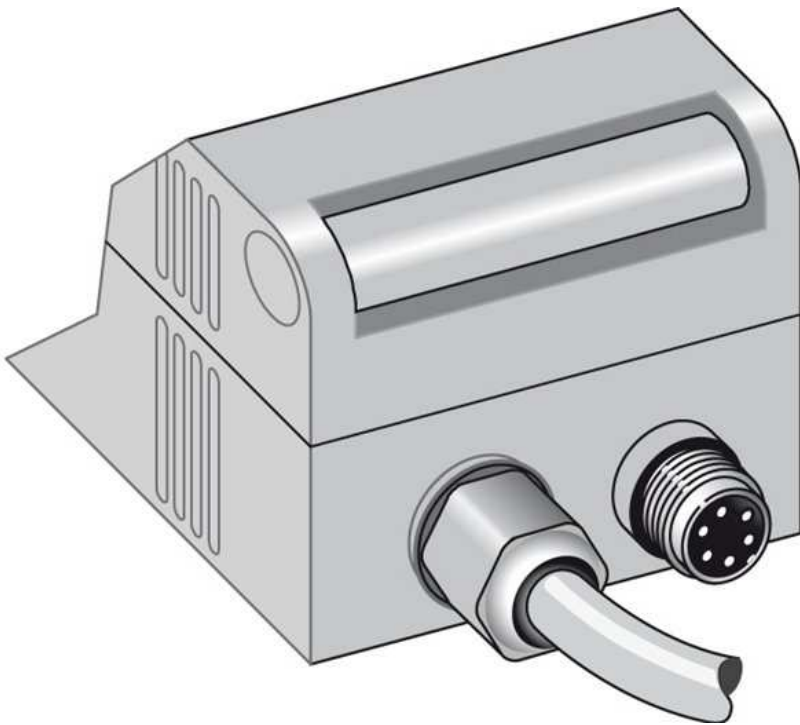

Australia

Phone +61 3 9457 0600
1800 33 48 02 – tollfree
E-Mail sales@sick.com.au

Belgium/Luxembourg

Phone +32 (0)2 466 55 66
E-Mail info@sick.be

Brasil

Phone +55 11 3215-4900
E-Mail marketing@sick.com.br

Canada

Phone +1 905 771 14 44
E-Mail information@sick.com

Česká republika

Phone +420 2 57 91 18 50
E-Mail sick@sick.cz

China

Phone +86 4000 121 000
E-Mail info.china@sick.net.cn
Phone +852-2153 6300
E-Mail ghk@sick.com.hk

Danmark

Phone +45 45 82 64 00
E-Mail sick@sick.dk

Deutschland

Phone +49 211 5301-301
E-Mail info@sick.de

España

Phone +34 93 480 31 00
E-Mail info@sick.es

France

Phone +33 1 64 62 35 00
E-Mail info@sick.fr

Great Britain

Phone +44 (0)1727 831121
E-Mail info@sick.co.uk

India

Phone +91-22-4033 8333
E-Mail info@sick-india.com

Israel

Phone +972-4-6881000
E-Mail info@sick-sensors.com

Italia

Phone +39 02 27 43 41
E-Mail info@sick.it

Japan

Phone +81 (0)3 5309 2112
E-Mail support@sick.jp

Magyarország

Phone +36 1 371 2680
E-Mail office@sick.hu

Nederland

Phone +31 (0)30 229 25 44
E-Mail info@sick.nl

Norge

Phone +47 67 81 50 00
E-Mail sick@sick.no

Österreich

Phone +43 (0)22 36 62 28 8-0
E-Mail office@sick.at

Polska

Phone +48 22 837 40 50
E-Mail info@sick.pl

România

Phone +40 356 171 120
E-Mail office@sick.ro

Russia

Phone +7-495-775-05-30
E-Mail info@sick.ru

Schweiz

Phone +41 41 619 29 39
E-Mail contact@sick.ch

Singapore

Phone +65 6744 3732
E-Mail sales.gsg@sick.com

Slovenija

Phone +386 (0)1-47 69 990
E-Mail office@sick.si

South Africa

Phone +27 11 472 3733
E-Mail info@sickautomation.co.za

South Korea

Phone +82 2 786 6321/4
E-Mail info@sickkorea.net

Suomi

Phone +358-9-25 15 800
E-Mail sick@sick.fi

Sverige

Phone +46 10 110 10 00
E-Mail info@sick.se

Taiwan

Phone +886 2 2375-6288
E-Mail sales@sick.com.tw

Türkiye

Phone +90 (216) 528 50 00
E-Mail info@sick.com.tr

United Arab Emirates

Phone +971 (0) 4 88 65 878
E-Mail info@sick.ae

USA/México

Phone +1(952) 941-6780
1 (800) 325-7425 – tollfree
E-Mail info@sickusa.com

More representatives and agencies
at www.sick.com