



Wire draw encoders HighLine

PRF13-A1AM0520



Model Name > PRF13-A1AM0520
Part No. > 1034324



Illustration may differ

At a glance

- Incremental wire draw encoders
- Modular measuring system with a wide selection of interfaces/measuring lengths
- Measuring lengths: 2 m ... 50 m
- Very rugged system (dirt wiper, integrated brushes), highly shock and vibration resistant
- High-quality winding mechanism and wire input
- Interfaces: - TTL/HTL
- High enclosure rating
- Highly resistant to shock and vibrations

Your benefits

- Reliable solution in harsh environments
- Long service life due to rugged industrial housing
- Quick and easy installation without the need for precise linear guidance
- Low integration and maintenance costs
- Customization option reduces inventory costs



Performance

Measurement range:	0 m ... 5 m
Repeatability:	≤ 1 mm ¹⁾
Linearity:	≤ ± 2 mm ²⁾
Hysteresis:	≤ 2 mm ³⁾
Resolution (wire draw + encoder)::	0.2 mm ^{4) 5)}

1) 3) Value refers to wire draw mechanism 2) 4) 5)

Mechanical data

Mass (including encoder):	3.1 kg
Measuring wire diameter:	1.35 mm
Measuring wire material:	Highly flexible stranded steel 1.4401 stainless steel V4A
Housing material, wire draw mechanism:	Aluminum (anodised), plastic
Spring return force:	15 N ... 20 N ¹⁾
Life of wire draw mechanism:	1 million cycles ²⁾
Actual length of cable extension:	5.2 m
Wire acceleration:	70 m/s ²
Operating speed:	4 m/s

Mounted encoder:	DFS60
Mounted mechanic:	MRA-F130-105D2
Part number mechanic:	6028626
Part number encoder:	-
Mass (measuring wire):	7.1 g/m
Length of wire pulled out per revolution:	334.1 mm ³⁾
Pulses per revolution:	1,670 ⁴⁾

1) These values were measured at an ambient temperature of 25 °C. There may be variations at other temperatures. ^{2) 3) 4)}

Electrical data

Maximum output frequency:	600 kHz
Reference signal, position:	Electronically, gated with A and B
Reference signal, number:	1, electronically, gated with A and B
Maximum load current:	30 mA
Initialization time::	≤ 32 ms, with mechanical zero pulse width ≤ 30 ms ^{1) 2)}
Supply voltage:	4.5 V ... 32 V
Power consumption:	0.7 W
MTTFd: mean time to dangerous failure::	300 a ^{3) 4)}

1) 2) Valid positional data can be read once this time has elapsed. ³⁾ This product is a standard product and does not constitute a

safety component as defined in the Machinery Directive.

Calculation based on nominal load of components, average ambient

temperature 40°C, frequency of use 8760 h/a. All

electronic failures are considered hazardous. For more information, see document no. 8015532. ⁴⁾ The value applies to the mounted encoder

Interfaces

Electrical interface:	4.5 V ... 5.5 V, TTL/RS422
Connection type:	Connector M23, 12-pin, radial
Encoder:	Incremental encoders

Ambient data

EMC:	(according to EN 61000-6-2 and EN 61000-6-3)
Enclosure rating encoder:	IP 67
Enclosure rating mechanic:	IP 64
Resistance to shocks:	60 g, 6 ms (according to EN 60068-2-27)
Resistance to vibration:	20 g, 10 Hz ... 2,000 Hz (according to EN 60068-2-6)
Relative humidity/Condensation:	90 % (condensation of the optical scanning not permitted)
Working temperature range (encoder):	-30 °C ... +70 °C
Working temperature range (mechanics):	-30 °C ... +70 °C
Working temperature range (combination):	Wird definiert durch den höheren minimalen und niedrigeren maximalen Wert des Arbeitstemperaturbereichs von Encoder und Mechanik

Dimensional drawing

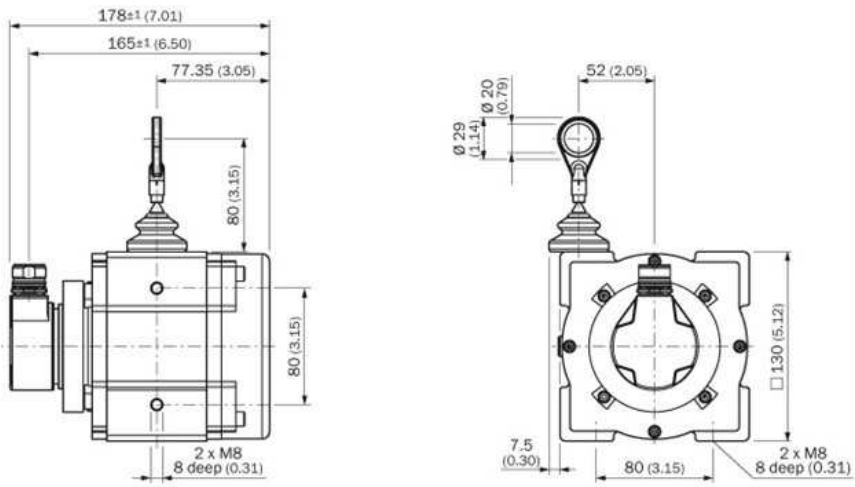

Australia

Phone +61 3 9457 0600
1800 33 48 02 – tollfree
E-Mail sales@sick.com.au

Belgium/Luxembourg

Phone +32 (0)2 466 55 66
E-Mail info@sick.be

Brasil

Phone +55 11 3215-4900
E-Mail marketing@sick.com.br

Canada

Phone +1 905 771 14 44
E-Mail information@sick.com

Česká republika

Phone +420 2 57 91 18 50
E-Mail sick@sick.cz

China

Phone +86 4000 121 000
E-Mail info.china@sick.net.cn
Phone +852-2153 6300
E-Mail ghk@sick.com.hk

Danmark

Phone +45 45 82 64 00
E-Mail sick@sick.dk

Deutschland

Phone +49 211 5301-301
E-Mail info@sick.de

España

Phone +34 93 480 31 00
E-Mail info@sick.es

France

Phone +33 1 64 62 35 00
E-Mail info@sick.fr

Great Britain

Phone +44 (0)1727 831121
E-Mail info@sick.co.uk

India

Phone +91-22-4033 8333
E-Mail info@sick-india.com

Israel

Phone +972-4-6881000
E-Mail info@sick-sensors.com

Italia

Phone +39 02 27 43 41
E-Mail info@sick.it

Japan

Phone +81 (0)3 5309 2112
E-Mail support@sick.jp

Magyarország

Phone +36 1 371 2680
E-Mail office@sick.hu

Nederland

Phone +31 (0)30 229 25 44
E-Mail info@sick.nl

Norge

Phone +47 67 81 50 00
E-Mail sick@sick.no

Österreich

Phone +43 (0)22 36 62 28 8-0
E-Mail office@sick.at

Polska

Phone +48 22 837 40 50
E-Mail info@sick.pl

România

Phone +40 356 171 120
E-Mail office@sick.ro

Russia

Phone +7-495-775-05-30
E-Mail info@sick.ru

Schweiz

Phone +41 41 619 29 39
E-Mail contact@sick.ch

Singapore

Phone +65 6744 3732
E-Mail sales.gsg@sick.com

Slovenija

Phone +386 (0)1-47 69 990
E-Mail office@sick.si

South Africa

Phone +27 11 472 3733
E-Mail info@sickautomation.co.za

South Korea

Phone +82 2 786 6321/4
E-Mail info@sickkorea.net

Suomi

Phone +358-9-25 15 800
E-Mail sick@sick.fi

Sverige

Phone +46 10 110 10 00
E-Mail info@sick.se

Taiwan

Phone +886 2 2375-6288
E-Mail sales@sick.com.tw

Türkiye

Phone +90 (216) 528 50 00
E-Mail info@sick.com.tr

United Arab Emirates

Phone +971 (0) 4 88 65 878
E-Mail info@sick.ae

USA/México

Phone +1(952) 941-6780
1 (800) 325-7425 – tollfree
E-Mail info@sickusa.com

More representatives and agencies
at www.sick.com