



Incremental encoders DKS40

DKS40-R5J00500



Model Name > [DKS40-R5J00500](#)
Part No. > [1034629](#)



Illustration may differ

At a glance

- Compact housing
- Durable, low-cost design
- Interfaces: Open collector NPN, TTL/RS-422 or HTL/push pull.
- Connection via cable outlet, for radial or axial use with open ends or fitted with an M12 connector
- Face mount flange with solid shaft
- Housing for simple clamping ring mounting
- Any line count possible from 1 to 2,048

Your benefits

- Low-cost encoder with outstanding quality
- Withstands harsh environmental conditions due to high IP protection class and rugged design
- Universal cable outlet enables axial and radial cable guidance
- Compact dimensions enable simple installation even where space is cramped



Performance

Measuring step:	90 °, Number of lines
Error limits binary number of lines:	0.09 °
Error limits non-binary number of lines:	0.13 °
Measuring step deviation at binary number of lines:	0.035 °
Measuring step deviation at non binary number of lines:	0.07 °
Initialization time:	40 s
Pulses per revolution:	500

Mechanical data

Mechanical interface:	Solid shaft, Face mount flange
Shaft diameter:	8 mm x 13 mm
Mass:	0.18 kg
Start up torque:	0.6 Ncm (+20 °C)
Operating torque:	0.4 Ncm (+20 °C)
Maximum operating speed:	6,000 U/min
Moment of inertia of the rotor:	6 gcm ²
Bearing lifetime:	2 x 10 ⁹ revolutions
Max. angular acceleration:	3,6 x 10 ⁹ rad/s ²
Permissible shaft loading radial/axial:	40 N, 20 N

Electrical data

Electrical interface:	10 V ... 30 V, Open Collector NPN, Cable, universal, 0.5 m
Connection type:	Cable, universal, 0.5 m
Operating power consumption (no load):	40 mA
Supply voltage:	10 V ... 30 V
Output current:	30 mA
Maximum output frequency:	50 kHz
Reference signal, number:	1
Reference signal, position:	90 °, electronically, gated with A and B
MTTFd: mean time to dangerous failure:	600 a (EN ISO 13849-1) ¹⁾

¹⁾ This product is a standard product and does not constitute a safety component as defined in the Machinery Directive.

Calculation based on nominal load of components, average ambient temperature 40°C, frequency of use 8760 h/a. All

electronic failures are considered hazardous. For more information, see document no. 8015532.

Ambient data

EMC:	EN 61000-6-2, EN 61000-6-3
Protection class housing side with cable outlet:	IP 64
Protection class shaft side:	IP 64
Protection class standard:	IEC 60529
Air humidity:	90 % ¹⁾
Working temperature range:	0 °C ... +60 °C
Storage temperature range:	-40 °C ... +70 °C, without package
Resistance to shocks:	50 g, 7 ms (EN 60068-2-27)
Resistance to vibration:	20 g, 10 Hz ... 2,000 Hz (EN 60068-2-6)

¹⁾ Condensation of the optical scanning not permitted

Dimensional drawing

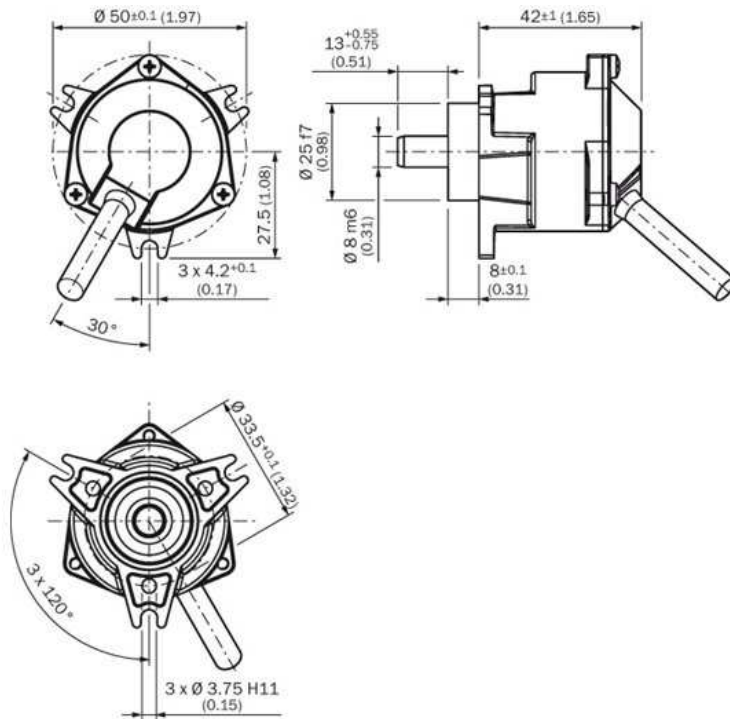

PIN assignment

8-core cable

View of the connector side of housing

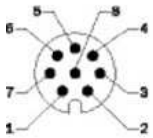

PIN, 8-pole in M12	Color of wires	Signal OC	Signal TTL, HTL	Explanation
1	Brown	Not connected	A	Signal line
2	White	A	A	Signal line
3	Black	Not connected	B	Signal line
4	Pink	B	B	Signal line
5	Yellow	Not connected	Z	Signal line
6	Lilac	Z	Z	Signal line
7	Blue	GND	GND	Ground connection of the encoder
8	Red	+U _s	+U _s	Supply voltage
Screen	Screen	Screen	Screen	Screen connected to encoder housing. Connect screen on control side.

Australia

Phone +61 3 9457 0600
1800 33 48 02 – tollfree
E-Mail sales@sick.com.au

Belgium/Luxembourg

Phone +32 (0)2 466 55 66
E-Mail info@sick.be

Brasil

Phone +55 11 3215-4900
E-Mail marketing@sick.com.br

Canada

Phone +1 905 771 14 44
E-Mail information@sick.com

Česká republika

Phone +420 2 57 91 18 50
E-Mail sick@sick.cz

China

Phone +86 4000 121 000
E-Mail info.china@sick.net.cn
Phone +852-2153 6300
E-Mail ghk@sick.com.hk

Danmark

Phone +45 45 82 64 00
E-Mail sick@sick.dk

Deutschland

Phone +49 211 5301-301
E-Mail info@sick.de

España

Phone +34 93 480 31 00
E-Mail info@sick.es

France

Phone +33 1 64 62 35 00
E-Mail info@sick.fr

Great Britain

Phone +44 (0)1727 831121
E-Mail info@sick.co.uk

India

Phone +91-22-4033 8333
E-Mail info@sick-india.com

Israel

Phone +972-4-6881000
E-Mail info@sick-sensors.com

Italia

Phone +39 02 27 43 41
E-Mail info@sick.it

Japan

Phone +81 (0)3 5309 2112
E-Mail support@sick.jp

Magyarország

Phone +36 1 371 2680
E-Mail office@sick.hu

Nederland

Phone +31 (0)30 229 25 44
E-Mail info@sick.nl

Norge

Phone +47 67 81 50 00
E-Mail sick@sick.no

Österreich

Phone +43 (0)22 36 62 28 8-0
E-Mail office@sick.at

Polska

Phone +48 22 837 40 50
E-Mail info@sick.pl

România

Phone +40 356 171 120
E-Mail office@sick.ro

Russia

Phone +7-495-775-05-30
E-Mail info@sick.ru

Schweiz

Phone +41 41 619 29 39
E-Mail contact@sick.ch

Singapore

Phone +65 6744 3732
E-Mail sales.gsg@sick.com

Slovenija

Phone +386 (0)1-47 69 990
E-Mail office@sick.si

South Africa

Phone +27 11 472 3733
E-Mail info@sickautomation.co.za

South Korea

Phone +82 2 786 6321/4
E-Mail info@sickkorea.net

Suomi

Phone +358-9-25 15 800
E-Mail sick@sick.fi

Sverige

Phone +46 10 110 10 00
E-Mail info@sick.se

Taiwan

Phone +886 2 2375-6288
E-Mail sales@sick.com.tw

Türkiye

Phone +90 (216) 528 50 00
E-Mail info@sick.com.tr

United Arab Emirates

Phone +971 (0) 4 88 65 878
E-Mail info@sick.ae

USA/México

Phone +1(952) 941-6780
1 (800) 325-7425 – tollfree
E-Mail info@sickusa.com

More representatives and agencies
at www.sick.com