



Wire draw encoders Compact

XKS09-HTBM0527



Model Name > [XKS09-HTBM0527](#)
Part No. > [1035437](#)

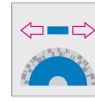

Illustration may differ

At a glance

- Absolute encoder
- Compact housing (90 x 90 x 90 mm)
- Encoder integrated into housing
- Measuring lengths from 2 to 5 m
- High resolution
- Interfaces: HIPERFACE®, PROFIBUS, CANopen and DeviceNET (with adapter)

Your benefits

- Industrial designed encoder integrated in an aluminum housing makes it less susceptible to external damage, saving time and reducing maintenance costs
- Extremely precise measurements by eliminating the coupling between the encoder and the mechanism
- Space-saving installation, since the encoder is directly integrated into the wire draw mechanics.
- Very precise measurements thanks to the high resolution
- No reference run necessary thanks to the absolute measuring principle



Performance

Measurement range:	0 m ... 5 m
Length of period:	1.195 mm
Linearity:	≤ ± 0.7 mm
Non-linearity:	± 0.1 mm
Piston speed:	3.5 m/s
Repeat accuracy typ:	≤ 0.15 °

Mechanical data

Mass:	1.5 kg
Measuring wire diameter:	0.6 mm
Measuring wire material:	Highly flexible stranded steel (PA 12 sheathed)
Housing material:	Aluminum
Spring return force:	4 N ... 6 N ¹⁾
Life of wire draw mechanism::	800,000 cycles ^{2) 3)}
Wire acceleration:	≤ 20 m/s ²

¹⁾ These values were measured at an ambient temperature of 25 °C. There may be variations at other temperatures. ^{2) 3)} At high operating speeds over great lengths,

this figure can decrease; at slow operating speeds over short lengths, it can increase.

Electrical data

Operating current:	60 mA (without load)
Output frequency for sine/cosine signals:	0 kHz ... 65 kHz
Available memory area:	1,792 Byte
Supply voltage:	7 V ... 12 V
Code type:	Binary
Code sequence:	Rising at wire pull-out
MTTFd: mean time to dangerous failure:	250 a (EN ISO 13849) ¹⁾
EEProm:	2048 Eeprom

¹⁾ This product is a standard product and does not constitute a safety component as defined in the Machinery Directive.

Calculation based on nominal load of components, average ambient temperature 40°C, frequency of use 8760 h/a. All

electronic failures are considered hazardous. For more information, see document no. 8015532.

Interfaces

Electrical interface:	7 V ... 12 V, HIPERFACE®
Connection type:	Male connector M12, 8-pin, radial
Interface signals:	Parameter channel RS-485: digital, Process data channel SIN, REFSIN, COS, REFCOS: analog, differential
Number of sine/cosine periods per revolution:	128
Encoder:	Absolute encoders

Ambient data

EMC:	(according to EN 61000-6-2 and EN 61000-6-3)
Enclosure rating encoder:	IP 52 (according to IEC 60529), Note required mounting position
Resistance to shocks:	20 g, 6 ms (according to EN 60068-2-27)
Resistance to vibration:	10 g, 10 Hz ... 2,000 Hz (according to EN 60068-2-6)
Storage temperature range:	-20 °C ... +80 °C
Relative humidity/Condensation:	90 % (Condensation not permitted)
Working temperature range (encoder):	-10 °C ... +70 °C

Dimensional drawing

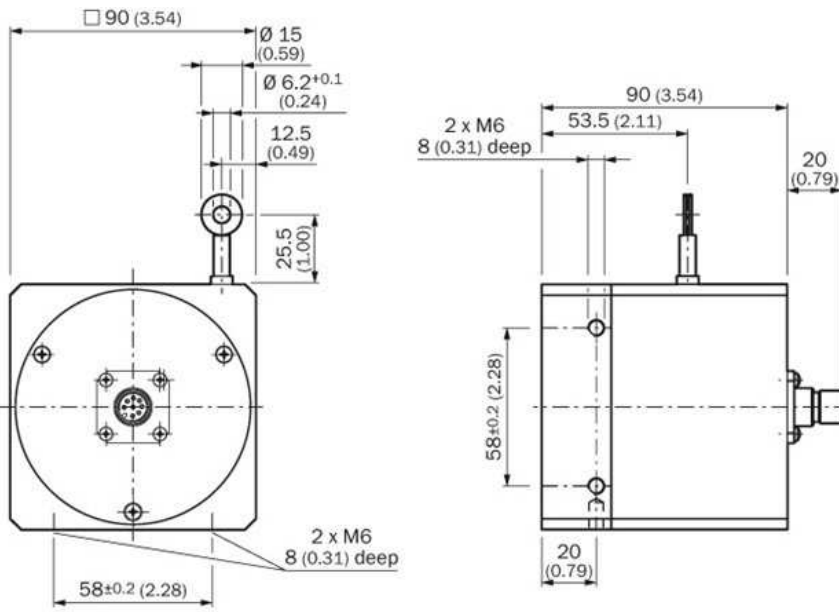

Australia

Phone +61 3 9457 0600
1800 33 48 02 – tollfree
E-Mail sales@sick.com.au

Belgium/Luxembourg

Phone +32 (0)2 466 55 66
E-Mail info@sick.be

Brasil

Phone +55 11 3215-4900
E-Mail marketing@sick.com.br

Canada

Phone +1 905 771 14 44
E-Mail information@sick.com

Česká republika

Phone +420 2 57 91 18 50
E-Mail sick@sick.cz

China

Phone +86 4000 121 000
E-Mail info.china@sick.net.cn
Phone +852-2153 6300
E-Mail ghk@sick.com.hk

Danmark

Phone +45 45 82 64 00
E-Mail sick@sick.dk

Deutschland

Phone +49 211 5301-301
E-Mail info@sick.de

España

Phone +34 93 480 31 00
E-Mail info@sick.es

France

Phone +33 1 64 62 35 00
E-Mail info@sick.fr

Great Britain

Phone +44 (0)1727 831121
E-Mail info@sick.co.uk

India

Phone +91-22-4033 8333
E-Mail info@sick-india.com

Israel

Phone +972-4-6881000
E-Mail info@sick-sensors.com

Italia

Phone +39 02 27 43 41
E-Mail info@sick.it

Japan

Phone +81 (0)3 5309 2112
E-Mail support@sick.jp

Magyarország

Phone +36 1 371 2680
E-Mail office@sick.hu

Nederland

Phone +31 (0)30 229 25 44
E-Mail info@sick.nl

Norge

Phone +47 67 81 50 00
E-Mail sick@sick.no

Österreich

Phone +43 (0)22 36 62 28 8-0
E-Mail office@sick.at

Polska

Phone +48 22 837 40 50
E-Mail info@sick.pl

România

Phone +40 356 171 120
E-Mail office@sick.ro

Russia

Phone +7-495-775-05-30
E-Mail info@sick.ru

Schweiz

Phone +41 41 619 29 39
E-Mail contact@sick.ch

Singapore

Phone +65 6744 3732
E-Mail sales.gsg@sick.com

Slovenija

Phone +386 (0)1-47 69 990
E-Mail office@sick.si

South Africa

Phone +27 11 472 3733
E-Mail info@sickautomation.co.za

South Korea

Phone +82 2 786 6321/4
E-Mail info@sickkorea.net

Suomi

Phone +358-9-25 15 800
E-Mail sick@sick.fi

Sverige

Phone +46 10 110 10 00
E-Mail info@sick.se

Taiwan

Phone +886 2 2375-6288
E-Mail sales@sick.com.tw

Türkiye

Phone +90 (216) 528 50 00
E-Mail info@sick.com.tr

United Arab Emirates

Phone +971 (0) 4 88 65 878
E-Mail info@sick.ae

USA/México

Phone +1(952) 941-6780
1 (800) 325-7425 – tollfree
E-Mail info@sickusa.com

More representatives and agencies
at www.sick.com