



Linear encoders KH53

KHK53-AXB00548



Model Name > [KHK53-AXB00548](#)
Part No. > [1035449](#)



Illustration may differ

At a glance

- Non-contact length measurement - maintenance-free, rugged, long lifetime
- High reproducibility (0.3 mm / 1 mm), high system resolution (0.1 mm)
- SSI and PROFIBUS interfaces
- Determination of absolute position
- Measuring lengths of up to 1,700 m possible
- Can be used in harsh environments
- High travel speeds of up to 6.6 m/s
- Distance tolerance between read head and measuring element: up to 55 mm ± 20 mm possible

Your benefits

- After installation, the system is immediately available and completely maintenance-free, which leads to time and cost savings.
- Reliable determination of position under harshest environmental conditions such as influences of dirt, dust, fog, shocks and vibrations
- High efficiency and productivity
- Savings on time - no reference run necessary on initial operation due to absolute position measurement
- accurate positioning even with high mounting tolerances



Performance

Measuring length:	0 m ... 548 m
Measurement range:	548 m
Resolution:	0.1 mm
Piston speed:	6.6 m/s ¹⁾
Measurement accuracy:	± 2000 + ME (Tu-25° C) Tk μm ²⁾
Repeatability (Ta not constant):	1 mm

¹⁾ If the max. movement speed is exceeded or the read head cannot detect a measuring element the error message FF FF FE Hex is produced. ²⁾ If the read head and measuring element are mounted within ± 1 mm of the nominal mounting distance in the N and Y directions. The figures quoted related to the accuracy within a measuring element with reference to the start of that measuring element. ME = length measuring element Tu = Ambient temperature °C

Mechanical data

Connection type:	Connector M23, 12-pin
Mass:	6.7 kg
Position tolerance:	± 20 mm

Material: AIMgSiPbF28

Electrical data

Initialization time:	2 s
Position forming time:	0.8 ms
Supply voltage:	10 V ... 32 V
Power consumption:	250 mA
MTTFd: mean time to dangerous failure:	22 a (EN ISO 13849) ¹⁾

¹⁾ This product is a standard product and does not constitute a safety component as defined in the Machinery Directive.

Calculation based on nominal load of components, average ambient temperature 40°C, frequency of use 8760 h/a. All

electronic failures are considered hazardous. For more information, see document no. 8015532.

Interfaces

Electrical interface:	SSI
Interface signals:	Digital, serial
Interface for parametrization:	Data format: 1 start bit, 8 data bits, 1 stop bit, no parity, Data protocol: ASCII, Baud rate 9600 RS-422, RS-422, Four wire transmission, asynchrony, full duplex
Data format:	SSI 24 bits format
Standard (default setting SSI standard):	RS-422 off

Ambient data

EMC:	(according to EN 61000-6-2 and EN 61000-6-4) ¹⁾
Enclosure rating:	IP 65 (IEC 60529), with mating connector inserted
Working temperature range:	-30 °C ... +70 °C
Storage temperature range:	-40 °C ... +85 °C
Resistance to shocks:	30 g, 10 ms (DIN EN 60 068-2-27)
Resistance to vibration:	10 g, 20 Hz ... 250 Hz (EN 60068-2-6)

¹⁾

Dimensional drawing

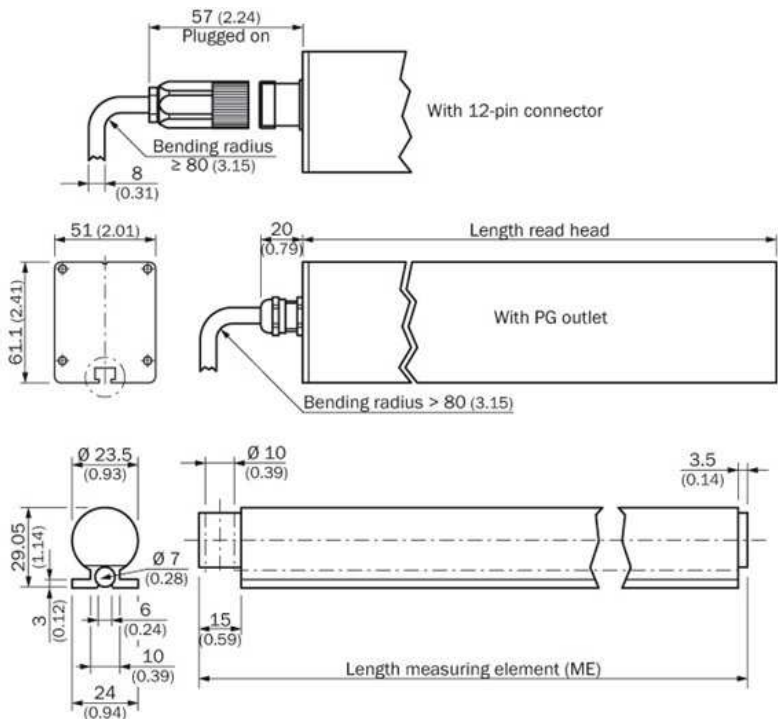

Position tolerance

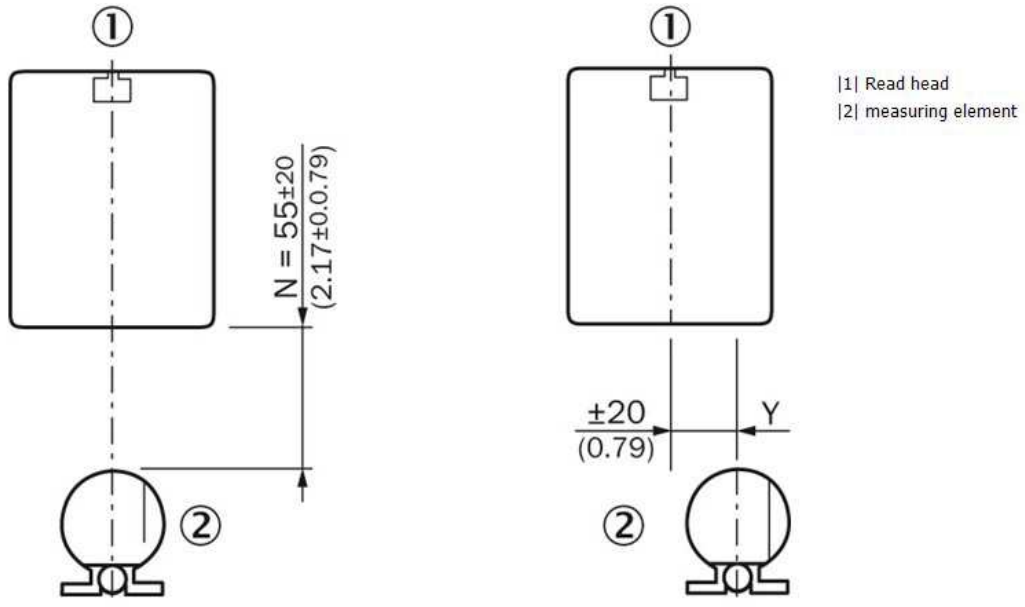

All dimensions in mm (inch)

PIN assignment

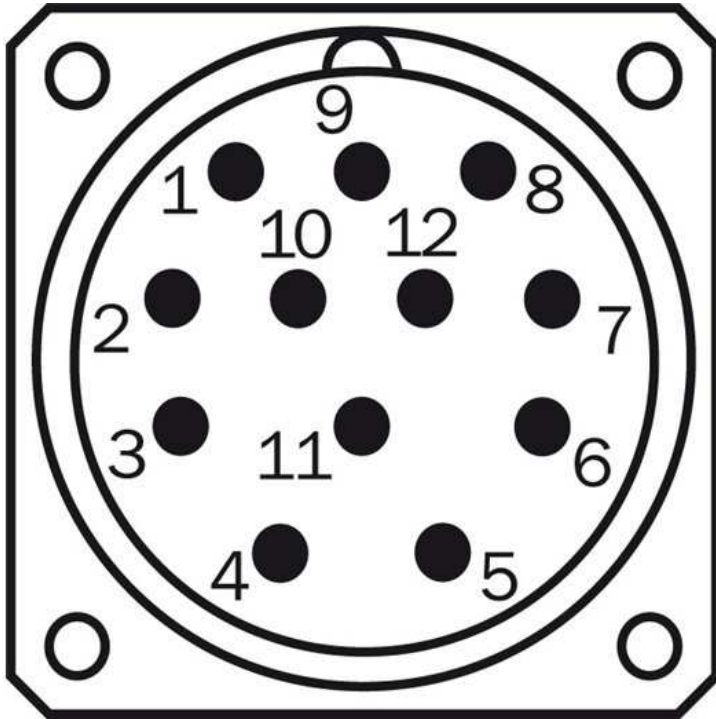

Australia

Phone +61 3 9457 0600
1800 33 48 02 – tollfree
E-Mail sales@sick.com.au

Belgium/Luxembourg

Phone +32 (0)2 466 55 66
E-Mail info@sick.be

Brasil

Phone +55 11 3215-4900
E-Mail marketing@sick.com.br

Canada

Phone +1 905 771 14 44
E-Mail information@sick.com

Česká republika

Phone +420 2 57 91 18 50
E-Mail sick@sick.cz

China

Phone +86 4000 121 000
E-Mail info.china@sick.net.cn
Phone +852-2153 6300
E-Mail ghk@sick.com.hk

Danmark

Phone +45 45 82 64 00
E-Mail sick@sick.dk

Deutschland

Phone +49 211 5301-301
E-Mail info@sick.de

España

Phone +34 93 480 31 00
E-Mail info@sick.es

France

Phone +33 1 64 62 35 00
E-Mail info@sick.fr

Great Britain

Phone +44 (0)1727 831121
E-Mail info@sick.co.uk

India

Phone +91-22-4033 8333
E-Mail info@sick-india.com

Israel

Phone +972-4-6881000
E-Mail info@sick-sensors.com

Italia

Phone +39 02 27 43 41
E-Mail info@sick.it

Japan

Phone +81 (0)3 5309 2112
E-Mail support@sick.jp

Magyarország

Phone +36 1 371 2680
E-Mail office@sick.hu

Nederland

Phone +31 (0)30 229 25 44
E-Mail info@sick.nl

Norge

Phone +47 67 81 50 00
E-Mail sick@sick.no

Österreich

Phone +43 (0)22 36 62 28 8-0
E-Mail office@sick.at

Polska

Phone +48 22 837 40 50
E-Mail info@sick.pl

România

Phone +40 356 171 120
E-Mail office@sick.ro

Russia

Phone +7-495-775-05-30
E-Mail info@sick.ru

Schweiz

Phone +41 41 619 29 39
E-Mail contact@sick.ch

Singapore

Phone +65 6744 3732
E-Mail sales.gsg@sick.com

Slovenija

Phone +386 (0)1-47 69 990
E-Mail office@sick.si

South Africa

Phone +27 11 472 3733
E-Mail info@sickautomation.co.za

South Korea

Phone +82 2 786 6321/4
E-Mail info@sickkorea.net

Suomi

Phone +358-9-25 15 800
E-Mail sick@sick.fi

Sverige

Phone +46 10 110 10 00
E-Mail info@sick.se

Taiwan

Phone +886 2 2375-6288
E-Mail sales@sick.com.tw

Türkiye

Phone +90 (216) 528 50 00
E-Mail info@sick.com.tr

United Arab Emirates

Phone +971 (0) 4 88 65 878
E-Mail info@sick.ae

USA/México

Phone +1(952) 941-6780
1 (800) 325-7425 – tollfree
E-Mail info@sickusa.com

More representatives and agencies
at www.sick.com