



Motor feedback systems rotary incremental VFS60

VFS60E-T5CK02048

Model Name > [VFS60E-T5CK02048](#)
Part No. > [1036101](#)



At a glance

- TTL, HTL or sine 0.5 VSS interfaces
- Resolution of up to 65,536 lines per revolution
- Individual programming of the interface, line count and of the zero pulse
- Direct programming via RS485
- Excellent concentricity through large distance between the ball bearings
- Exceptional robustness and protection class IP 65
- Mechanical flexibility through blind hollow shaft and through hollow shafts with diameters of 8 to 15 mm, available with various torque supports
- Temperature range from -30 °C to +100 °C

Your benefits

- Programmable version for a reduced product variety
- Various programming tools designed to take into account your own programming requirements
- High performance and reliability even in rough ambient conditions
- Large ball bearing distances reduce uneven wear and minimize vibration on the motor feedback housing, which increases the motor feedback system's service life
- High vibration resistance and extended temperature range through nickel code disk



Performance

| | |
|---------------------------------|---|
| Number of lines per revolution: | 2,048 |
| Reference signal, number: | 1 |
| Reference signal, position: | 90 ° electronically, gated with A and B |
| Error limits: | ± 0.3 ° |
| Measuring step deviation: | ± 0.2 ° |
| Maximum initialisation time: | 40 ms |

Mechanical data

| | |
|---------------------------------|-------------------------|
| Shaft diameter: | 12 mm |
| Shaft material: | Plastic |
| Shaft plug-in length: | ≥ 48 mm |
| Flange type/stator coupling: | Standard |
| Dimensions: | See dimensional drawing |
| Mass: | 0.2 kg |
| Moment of inertia of the rotor: | 40 gcm ² |

| | |
|--|---|
| Maximum operating speed: | 9,000 /min ¹⁾ |
| Maximum angular acceleration: | 500,000 rad/s ² |
| Operating torque: | 0.6 Ncm (20 °C) |
| Start up torque: | 0.8 Ncm (20 °C) |
| Permissible shaft movement, radial, dynamic: | ± 0.1 mm |
| Permissible shaft movement, axial, dynamic: | ± 0.2 mm |
| Life of ball bearings: | 3.0 x 10 ⁹ revolutions |
| Connection type: | Cable, 8-pin, radial, 1.5 m ²⁾ |

¹⁾ Self-warming 3.3 K/1,000 1/min, when applying note working temperature range ²⁾ The universal cable outlet is positioned in such a way, that it is possible to lay the cable in a radial or axial direction without kinking it

Electrical data

| | |
|---|---------------------|
| Electrical interface: | TTL/RS422 |
| Operating voltage range/supply Voltage: | 10 V ... 32 V |
| Maximum output frequency: | 300 kHz |
| Maximum load current: | 30 mA |
| Operating power consumption (no load): | 40 mA ¹⁾ |

¹⁾ Without load

Ambient data

| | |
|---------------------------------|---|
| Working temperature range: | -30 °C ... 100 °C |
| Storage temperature range: | -40 °C ... 100 °C, without package |
| Relative humidity/Condensation: | 90 %, condensation of the optical scanning not permitted |
| Resistance to shocks: | 70 g, 6 ms (according to EN 60068-2-27) |
| Resistance to vibration: | 30 g, 10 Hz ... 2,000 Hz (according to EN 60068-2-6) |
| EMC: | (according to EN 61000-6-2 and EN 61000-6-4) |
| Enclosure rating: | IP 65 (according to IEC 60529), housing side cable outlet, IP 65 (according to IEC 60529), shaft side |

Dimensional drawing

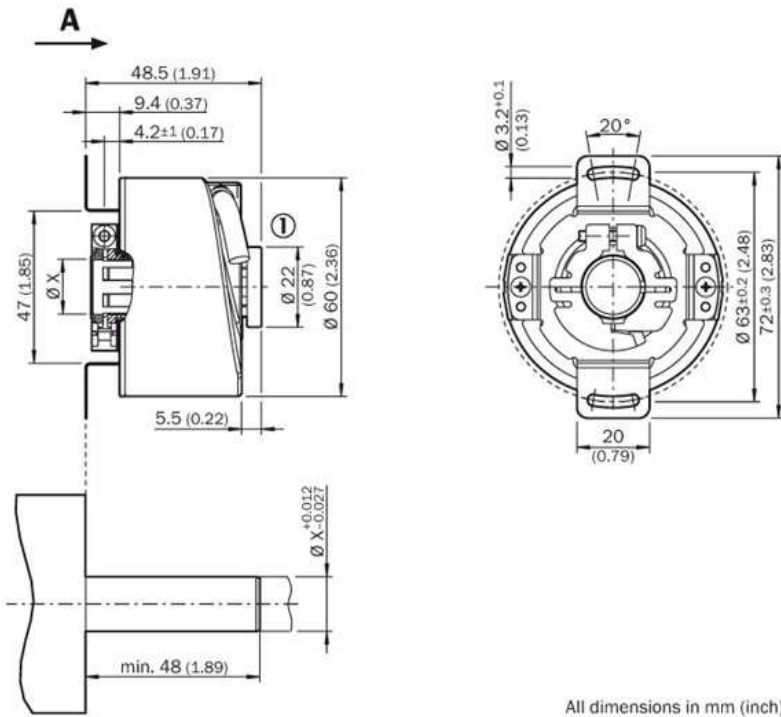

All dimensions in mm (inch)

Australia

Phone +61 3 9457 0600
1800 33 48 02 – tollfree
E-Mail sales@sick.com.au

Belgium/Luxembourg

Phone +32 (0)2 466 55 66
E-Mail info@sick.be

Brasil

Phone +55 11 3215-4900
E-Mail marketing@sick.com.br

Canada

Phone +1 905 771 14 44
E-Mail information@sick.com

Česká republika

Phone +420 2 57 91 18 50
E-Mail sick@sick.cz

China

Phone +86 4000 121 000
E-Mail info.china@sick.net.cn
Phone +852-2153 6300
E-Mail ghk@sick.com.hk

Danmark

Phone +45 45 82 64 00
E-Mail sick@sick.dk

Deutschland

Phone +49 211 5301-301
E-Mail info@sick.de

España

Phone +34 93 480 31 00
E-Mail info@sick.es

France

Phone +33 1 64 62 35 00
E-Mail info@sick.fr

Great Britain

Phone +44 (0)1727 831121
E-Mail info@sick.co.uk

India

Phone +91-22-4033 8333
E-Mail info@sick-india.com

Israel

Phone +972-4-6881000
E-Mail info@sick-sensors.com

Italia

Phone +39 02 27 43 41
E-Mail info@sick.it

Japan

Phone +81 (0)3 5309 2112
E-Mail support@sick.jp

Magyarország

Phone +36 1 371 2680
E-Mail office@sick.hu

Nederland

Phone +31 (0)30 229 25 44
E-Mail info@sick.nl

Norge

Phone +47 67 81 50 00
E-Mail sick@sick.no

Österreich

Phone +43 (0)22 36 62 28 8-0
E-Mail office@sick.at

Polska

Phone +48 22 837 40 50
E-Mail info@sick.pl

România

Phone +40 356 171 120
E-Mail office@sick.ro

Russia

Phone +7-495-775-05-30
E-Mail info@sick.ru

Schweiz

Phone +41 41 619 29 39
E-Mail contact@sick.ch

Singapore

Phone +65 6744 3732
E-Mail sales.gsg@sick.com

Slovenija

Phone +386 (0)1-47 69 990
E-Mail office@sick.si

South Africa

Phone +27 11 472 3733
E-Mail info@sickautomation.co.za

South Korea

Phone +82 2 786 6321/4
E-Mail info@sickkorea.net

Suomi

Phone +358-9-25 15 800
E-Mail sick@sick.fi

Sverige

Phone +46 10 110 10 00
E-Mail info@sick.se

Taiwan

Phone +886 2 2375-6288
E-Mail sales@sick.com.tw

Türkiye

Phone +90 (216) 528 50 00
E-Mail info@sick.com.tr

United Arab Emirates

Phone +971 (0) 4 88 65 878
E-Mail info@sick.ae

USA/México

Phone +1(952) 941-6780
1 (800) 325-7425 – tollfree
E-Mail info@sickusa.com

More representatives and agencies
at www.sick.com