



Motor feedback systems rotary incremental VFS60

VFS60E-T7CK01024

Model Name > [VFS60E-T7CK01024](#)
Part No. > [1036106](#)



At a glance

- TTL, HTL or sine 0.5 VSS interfaces
- Resolution of up to 65,536 lines per revolution
- Individual programming of the interface, line count and of the zero pulse
- Direct programming via RS485
- Excellent concentricity through large distance between the ball bearings
- Exceptional robustness and protection class IP 65
- Mechanical flexibility through blind hollow shaft and through hollow shafts with diameters of 8 to 15 mm, available with various torque supports
- Temperature range from -30 °C to +100 °C

Your benefits

- Programmable version for a reduced product variety
- Various programming tools designed to take into account your own programming requirements
- High performance and reliability even in rough ambient conditions
- Large ball bearing distances reduce uneven wear and minimize vibration on the motor feedback housing, which increases the motor feedback system's service life
- High vibration resistance and extended temperature range through nickel code disk



Performance

Number of lines per revolution:	1,024
Reference signal, number:	1
Reference signal, position:	90 ° electronically, gated with A and B
Error limits:	± 0.3 °
Measuring step deviation:	± 0.2 °
Maximum initialisation time:	40 ms

Mechanical data

Shaft diameter:	14 mm
Shaft material:	Plastic
Shaft plug-in length:	≥ 48 mm
Flange type/stator coupling:	Standard
Dimensions:	See dimensional drawing
Mass:	0.2 kg
Moment of inertia of the rotor:	40 gcm ²

Maximum operating speed:	9,000 /min ¹⁾
Maximum angular acceleration:	500,000 rad/s ²
Operating torque:	0.6 Ncm (20 °C)
Start up torque:	0.8 Ncm (20 °C)
Permissible shaft movement, radial, dynamic:	± 0.1 mm
Permissible shaft movement, axial, dynamic:	± 0.2 mm
Life of ball bearings:	3.0 x 10 ⁹ revolutions
Connection type:	Cable, 8-pin, radial, 1.5 m ²⁾

¹⁾ Self-warming 3.3 K/1,000 1/min, when applying note working temperature range ²⁾ The universal cable outlet is positioned in such a way, that it is possible to lay the cable in a radial or axial direction without kinking it

Electrical data

Electrical interface:	TTL/RS422
Operating voltage range/supply Voltage:	10 V ... 32 V
Maximum output frequency:	300 kHz
Maximum load current:	30 mA
Operating power consumption (no load):	40 mA ¹⁾

¹⁾ Without load

Ambient data

Working temperature range:	-30 °C ... 100 °C
Storage temperature range:	-40 °C ... 100 °C, without package
Relative humidity/Condensation:	90 %, condensation of the optical scanning not permitted
Resistance to shocks:	70 g, 6 ms (according to EN 60068-2-27)
Resistance to vibration:	30 g, 10 Hz ... 2,000 Hz (according to EN 60068-2-6)
EMC:	(according to EN 61000-6-2 and EN 61000-6-4)
Enclosure rating:	IP 65 (according to IEC 60529), housing side cable outlet, IP 65 (according to IEC 60529), shaft side

Dimensional drawing

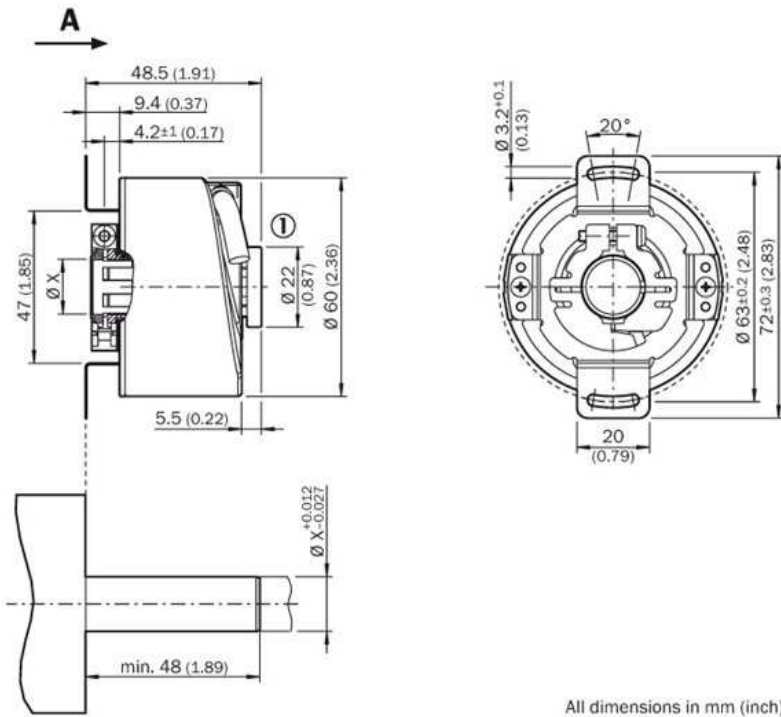

All dimensions in mm (inch)

Australia

Phone +61 3 9457 0600
1800 33 48 02 – tollfree
E-Mail sales@sick.com.au

Belgium/Luxembourg

Phone +32 (0)2 466 55 66
E-Mail info@sick.be

Brasil

Phone +55 11 3215-4900
E-Mail marketing@sick.com.br

Canada

Phone +1 905 771 14 44
E-Mail information@sick.com

Česká republika

Phone +420 2 57 91 18 50
E-Mail sick@sick.cz

China

Phone +86 4000 121 000
E-Mail info.china@sick.net.cn
Phone +852-2153 6300
E-Mail ghk@sick.com.hk

Danmark

Phone +45 45 82 64 00
E-Mail sick@sick.dk

Deutschland

Phone +49 211 5301-301
E-Mail info@sick.de

España

Phone +34 93 480 31 00
E-Mail info@sick.es

France

Phone +33 1 64 62 35 00
E-Mail info@sick.fr

Great Britain

Phone +44 (0)1727 831121
E-Mail info@sick.co.uk

India

Phone +91-22-4033 8333
E-Mail info@sick-india.com

Israel

Phone +972-4-6881000
E-Mail info@sick-sensors.com

Italia

Phone +39 02 27 43 41
E-Mail info@sick.it

Japan

Phone +81 (0)3 5309 2112
E-Mail support@sick.jp

Magyarország

Phone +36 1 371 2680
E-Mail office@sick.hu

Nederland

Phone +31 (0)30 229 25 44
E-Mail info@sick.nl

Norge

Phone +47 67 81 50 00
E-Mail sick@sick.no

Österreich

Phone +43 (0)22 36 62 28 8-0
E-Mail office@sick.at

Polska

Phone +48 22 837 40 50
E-Mail info@sick.pl

România

Phone +40 356 171 120
E-Mail office@sick.ro

Russia

Phone +7-495-775-05-30
E-Mail info@sick.ru

Schweiz

Phone +41 41 619 29 39
E-Mail contact@sick.ch

Singapore

Phone +65 6744 3732
E-Mail sales.gsg@sick.com

Slovenija

Phone +386 (0)1-47 69 990
E-Mail office@sick.si

South Africa

Phone +27 11 472 3733
E-Mail info@sickautomation.co.za

South Korea

Phone +82 2 786 6321/4
E-Mail info@sickkorea.net

Suomi

Phone +358-9-25 15 800
E-Mail sick@sick.fi

Sverige

Phone +46 10 110 10 00
E-Mail info@sick.se

Taiwan

Phone +886 2 2375-6288
E-Mail sales@sick.com.tw

Türkiye

Phone +90 (216) 528 50 00
E-Mail info@sick.com.tr

United Arab Emirates

Phone +971 (0) 4 88 65 878
E-Mail info@sick.ae

USA/México

Phone +1(952) 941-6780
1 (800) 325-7425 – tollfree
E-Mail info@sickusa.com

More representatives and agencies
at www.sick.com