



**Absolute encoders
AFS/AFM60 SSI**

AFM60A-S1AC004096



Model Name > **AFM60A-S1AC004096**
Part No. > **1037872**



Illustration may differ

At a glance

- High-resolution absolute encoders with up to 30 bits (AFM60) or up to 18 bits (AFS60)
- Face mount flange, servo flange, blind or through hollow shaft
- SSI, SSI + Incremental or SSI + Sin/Cos interface
- Programmable resolution and offset (dependent on type)
- Connection system: M12, M23 connector or cable outlet
- Enclosure rating: IP 67 (housing), IP 65 (shaft)
- Operating temperature: -30 °C to +100 °C (depends on type)

Your benefits

- Programmability of the encoders means less storage, greater machine availability and easy installation
- Precise positioning due to high resolutions
- Large selection of mechanical interfaces and electrical contacting possibilities: Suitable for all applications
- Suitable for applications with limited space requirements (extremely short installation depth of 30 mm)
- Very good rotation accuracy due to increased bearing distance
- One programming tool and software with automatic encoder detection for AFS60/AFM60/DFS60



Performance

Max. number of steps per revolution:	4,096
Max. number of revolutions:	4,096
Resolution power:	4,096 x 4,096
Resolution:	12 bit x 12 bit
Error limits:	± 0.03 °
Repeatability (Ta not constant):	0.002 °
Measuring step deviation:	± 0.008 °
Measuring step:	0.014 ° 360 ° / number of steps
Initialization time:	50 ms ¹⁾

¹⁾ Valid positional data can be read once this time has elapsed

Mechanical data

Mechanical interface:	Solid shaft, Servo flange
Shaft diameter:	6 mm

Mass:	0.26 kg
Start up torque:	0.5 Ncm (+20 °C)
Operating torque:	0.3 Ncm (+20 °C)
Permissible Load capacity of shaft:	40 N (axial), 80 N (radial)
Maximum operating speed:	9,000 /min ¹⁾
Moment of inertia of the rotor:	6.2 gcm ²
Bearing lifetime:	3.0 x 10 ⁹ revolutions
Max. angular acceleration:	500,000 rad/s ²

1) Self warming of 3.3 K per 1000 revolutions/min when applying note working temperature range

Electrical data

Power consumption:	0.5 W (without load)
Operating voltage range:	4.5 V DC ... 32 V DC
MTTFd: mean time to dangerous failure:	250 a (EN ISO 13849-1) ¹⁾
Connection type:	Male connector M12, 8-pin, radial
Code type:	Gray
Code sequence:	CW/CCW, parameter adjustable
Reverse polarity protection:	1

1) This product is a standard product and does not constitute a safety component as defined in the Machinery Directive.

Calculation based on nominal load of components, average ambient temperature 40°C, frequency of use 8760 h/a. All

electronic failures are considered hazardous. For more information, see document no. 8015532.

Interfaces

Electrical interface:	SSI/Gray
Interface signals:	Clock +, Clock -, Data +, Data-
Clock frequency:	2 MHz ¹⁾
SET (electronic adjustment):	H-active (L ≡ 0 - 1,5 V, H ≡ 2,0 - Us V)
CW/CCW (counting sequence when turning):	L-active (L ≡ 0 - 1,5 V, H ≡ 2,0 - Us V)

1)

Ambient data

EMC:	(according to EN 61000-6-2 and EN 61000-6-3) ¹⁾
Enclosure rating:	IP 65 (according to IEC 60529), shaft side, IP 67 (according to IEC 60529), housing side ²⁾
Permissible relative humidity:	90 % (condensation of the optical scanning not permitted)
Working temperature range:	-30 °C ... +100 °C
Storage temperature range:	-40 °C ... +100 °C, without package
Resistance to shocks:	60 g, 6 ms (according to EN 60068-2-27)
Resistance to vibration:	20 g, 10 Hz ... 2,000 Hz (according to EN 60068-2-6)

1) 2) With mating connector fitted

Dimensional drawing

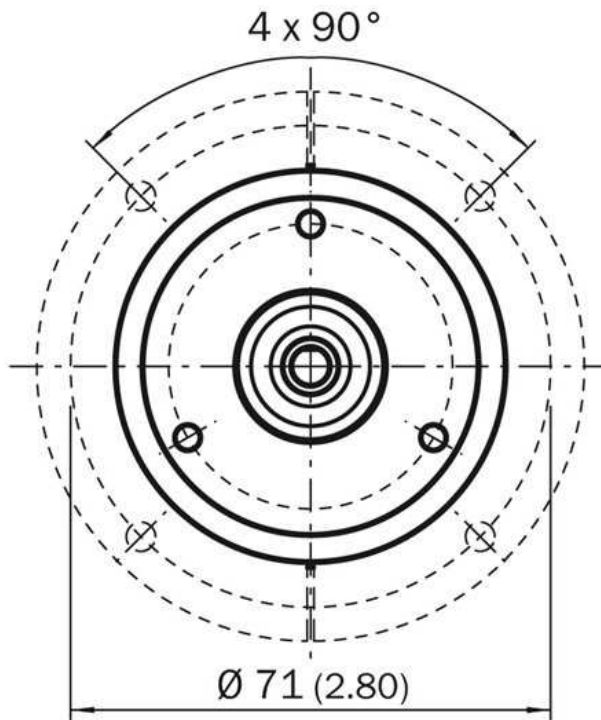

PIN assignment

Pin	Color wires	Signal SSI	Explanation
1	Brown	Data-	Interface signals
2	White	Data+	Interface signals
3	Black	CW/CCW	Counting sequence when turning
4	Pink	SET	Electronic adjustment
5	Yellow	Clock+	Interface signals
6	Lilac	Clock-	Interface signals
7	Blue	GND	Ground connection
8	Red	+U _s	Supply voltage
	Screen		Screen on the encoder side connected to the housing. On the control side connected to earth.

Signalausgänge

SSI data format singleturn



Bit 1-16: Position Bits

- LSD: Least significant Bit
- MSB: Most significant Bit

Bit 19-21: Error Bits

- ERRDIG: Failure message about speed. If this failure occurs during the position building procedure it will be indicated by the ERRDIG-Bit.
- ERRSL: Light source monitoring failure.
- ERRSYNC: Contamination of the disc or scanning system. During the determination of the position, an error has occurred since the last SSI transmission. The error bit will be deleted during the next data transmission.

The evaluation of the error bits has to be realized in the PLC.

The provided error bits don't have to be used by the PLC compulsorily.

Example

If the resolution of the absolute encoder is set on 13 bits, 16 bits are provided by the encoder: 13 data bits and 3 error bits. If the PLC is not able to evaluate the error bits, the PLC has to be set on a resolution of 13 bits. Then the error bits have to be masked out by the PLC.

SSI data format multiturn

30 Bits

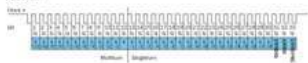

- Bit 1-12: Position Bits multiturn
- Bit 13-24: Position Bits singleturn
- Bit 25-30: Error Bits

27 Bits

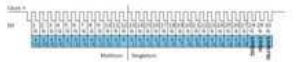

- Bit 1-12: Position Bits multiturn
- Bit 13-27: Position Bits singleturn
- Bit 28-30: Error Bits

Error Bits

- ERRDIG: Failure message about speed. If this failure occurs during the position building procedure it will be indicated by the ERRDIG-Bit.
- ERRSL: Light source monitoring failure.
- ERRSYNC: Contamination of the disc or scanning system. During the determination of the position, an error has occurred since the last SSI transmission. The error bit will be deleted during the next data transmission.

The evaluation of the error bits has to be realized in the PLC.

The provided error bits don't have to be used by the PLC compulsorily. The multiturn resolution is fixed on 12 bits.

Example

If the resolution of the absolute encoder is set on 27 bits, 30 bits are provided by the encoder: 27 data bits and 3 error bits. If the PLC is not able to evaluate the error bits, the PLC has to be set on a resolution of 27 bits. Then the error bits have to be masked out by the PLC.

Drehzahlbetrachtung

Speed consideration (n)

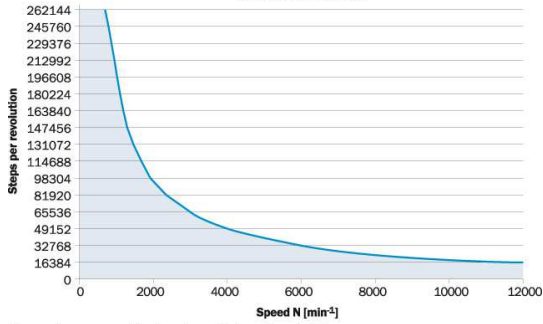

The maximum speed is also dependent on the shaft type.

Signalausgänge

SSI data format singleturn



Bit 1-16: Position Bits

- LSD: Least significant Bit
- MSB: Most significant Bit

Bit 19-21: Error Bits

- ERRDIG: Failure message about speed. If this failure occurs during the position building procedure it will be indicated by the ERRDIG-Bit.
- ERRSL: Light source monitoring failure.
- ERRSYNC: Contamination of the disc or scanning system. During the determination of the position, an error has occurred since the last SSI transmission. The error bit will be deleted during the next data transmission.

The evaluation of the error bits has to be realized in the PLC.

The provided error bits don't have to be used by the PLC compulsorily.

Example

If the resolution of the absolute encoder is set on 13 bits, 16 bits are provided by the encoder: 13 data bits and 3 error bits. If the PLC is not able to evaluate the error bits, the PLC has to be set on a resolution of 13 bits. Then the error bits have to be masked out by the PLC.

SSI data format multiturn

30 Bits



- Bit 1-12: Position Bits multiturn
- Bit 13-24: Position Bits singleturn
- Bit 25-30: Error Bits

27 Bits



- Bit 1-12: Position Bits multiturn
- Bit 13-27: Position Bits singleturn
- Bit 28-30: Error Bits

Error Bits

- ERRDIG: Failure message about speed. If this failure occurs during the position building procedure it will be indicated by the ERRDIG-Bit.
- ERRSL: Light source monitoring failure.
- ERRSYNC: Contamination of the disc or scanning system. During the determination of the position, an error has occurred since the last SSI transmission. The error bit will be deleted during the next data transmission.

The evaluation of the error bits has to be realized in the PLC.

The provided error bits don't have to be used by the PLC compulsorily. The multiturn resolution is fixed on 12 bits.

Example

If the resolution of the absolute encoder is set on 27 bits, 30 bits are provided by the encoder: 27 data bits and 3 error bits. If the PLC is not able to evaluate the error bits, the PLC has to be set on a resolution of 27 bits. Then the error bits have to be masked out by the PLC.

Interfaces

Electrical interfaces sine 0.5 V_r

Power supply	Output
±5...±15 V	±0.5 V _r

Signal before differential generation at load 120 Ω at U_r = 5 V

Signal diagram for absolute rotation of the shaft looking in direction "A" (shaft)

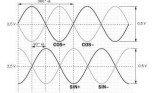

Signal after differential generation at load 120 Ω at U_r = 5 V

Signal diagram for absolute rotation of the shaft looking in direction "A" (shaft)

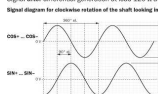

Incremental pulse diagram for absolute rotation of the shaft looking in direction "A", see dimensional drawing

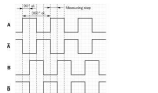

Australia

Phone +61 3 9457 0600
1800 33 48 02 – tollfree
E-Mail sales@sick.com.au

Belgium/Luxembourg

Phone +32 (0)2 466 55 66
E-Mail info@sick.be

Brasil

Phone +55 11 3215-4900
E-Mail marketing@sick.com.br

Canada

Phone +1 905 771 14 44
E-Mail information@sick.com

Česká republika

Phone +420 2 57 91 18 50
E-Mail sick@sick.cz

China

Phone +86 4000 121 000
E-Mail info.china@sick.net.cn
Phone +852-2153 6300
E-Mail ghk@sick.com.hk

Danmark

Phone +45 45 82 64 00
E-Mail sick@sick.dk

Deutschland

Phone +49 211 5301-301
E-Mail info@sick.de

España

Phone +34 93 480 31 00
E-Mail info@sick.es

France

Phone +33 1 64 62 35 00
E-Mail info@sick.fr

Great Britain

Phone +44 (0)1727 831121
E-Mail info@sick.co.uk

India

Phone +91-22-4033 8333
E-Mail info@sick-india.com

Israel

Phone +972-4-6881000
E-Mail info@sick-sensors.com

Italia

Phone +39 02 27 43 41
E-Mail info@sick.it

Japan

Phone +81 (0)3 5309 2112
E-Mail support@sick.jp

Magyarország

Phone +36 1 371 2680
E-Mail office@sick.hu

Nederland

Phone +31 (0)30 229 25 44
E-Mail info@sick.nl

Norge

Phone +47 67 81 50 00
E-Mail sick@sick.no

Österreich

Phone +43 (0)22 36 62 28 8-0
E-Mail office@sick.at

Polska

Phone +48 22 837 40 50
E-Mail info@sick.pl

România

Phone +40 356 171 120
E-Mail office@sick.ro

Russia

Phone +7-495-775-05-30
E-Mail info@sick.ru

Schweiz

Phone +41 41 619 29 39
E-Mail contact@sick.ch

Singapore

Phone +65 6744 3732
E-Mail sales.gsg@sick.com

Slovenija

Phone +386 (0)1-47 69 990
E-Mail office@sick.si

South Africa

Phone +27 11 472 3733
E-Mail info@sickautomation.co.za

South Korea

Phone +82 2 786 6321/4
E-Mail info@sickkorea.net

Suomi

Phone +358-9-25 15 800
E-Mail sick@sick.fi

Sverige

Phone +46 10 110 10 00
E-Mail info@sick.se

Taiwan

Phone +886 2 2375-6288
E-Mail sales@sick.com.tw

Türkiye

Phone +90 (216) 528 50 00
E-Mail info@sick.com.tr

United Arab Emirates

Phone +971 (0) 4 88 65 878
E-Mail info@sick.ae

USA/México

Phone +1(952) 941-6780
1 (800) 325-7425 – tollfree
E-Mail info@sickusa.com

More representatives and agencies
at www.sick.com