



**Absolute encoders  
AFS/AFM60 SSI**

AFM60E-S4AA000512

**Model Name** > [AFM60E-S4AA000512](#)  
**Part No.** > [1038078](#)



**At a glance**

- High-resolution absolute encoders with up to 30 bits (AFM60) or up to 18 bits (AFS60)
- Face mount flange, servo flange, blind or through hollow shaft
- SSI, SSI + Incremental or SSI + Sin/Cos interface
- Programmable resolution and offset (dependent on type)
- Connection system: M12, M23 connector or cable outlet
- Enclosure rating: IP 67 (housing), IP 65 (shaft)
- Operating temperature: -30 °C to +100 °C (depends on type)

**Your benefits**

- Programmability of the encoders means less storage, greater machine availability and easy installation
- Precise positioning due to high resolutions
- Large selection of mechanical interfaces and electrical contacting possibilities: Suitable for all applications
- Suitable for applications with limited space requirements (extremely short installation depth of 30 mm)
- Very good rotation accuracy due to increased bearing distance
- One programming tool and software with automatic encoder detection for AFS60/AFM60/DFS60



**Performance**

---

Max. number of steps per revolution:	512
Max. number of revolutions:	4,096
Resolution power:	512 x 4,096
Resolution:	9 bit x 12 bit
Error limits:	± 0.2 °
Repeatability (Ta not constant):	0.002 °
Measuring step deviation:	± 0.2 °
Measuring step:	0.09 ° 360 ° / number of steps
Initialization time:	50 ms <sup>1)</sup>

<sup>1)</sup> Valid positional data can be read once this time has elapsed

**Mechanical data**

---

Mechanical interface:	Solid shaft with flat, Face mount flange
Shaft diameter:	10 mm

Mass:	0.26 kg
Start up torque:	0.5 Ncm (+20 °C)
Operating torque:	0.3 Ncm (+20 °C)
Permissible Load capacity of shaft:	40 N (axial), 80 N (radial)
Maximum operating speed:	9,000 /min <sup>1)</sup>
Moment of inertia of the rotor:	6.2 gcm <sup>2</sup>
Bearing lifetime:	3.0 x 10 <sup>9</sup> revolutions
Max. angular acceleration:	500,000 rad/s <sup>2</sup>

<sup>1)</sup> Self warming of 3.3 K per 1000 revolutions/min when applying note working temperature range

### Electrical data

---

Power consumption:	0.5 W (without load)
Operating voltage range:	4.5 V DC ... 32 V DC
MTTFd: mean time to dangerous failure:	250 a (EN ISO 13849-1) <sup>1)</sup>
Connection type:	Connector M23, 12-pin, radial
Code type:	Gray
Code sequence:	CW/CCW, parameter adjustable
Reverse polarity protection:	1

<sup>1)</sup> This product is a standard product and does not constitute a safety component as defined in the Machinery Directive.

Calculation based on nominal load of components, average ambient temperature 40°C, frequency of use 8760 h/a. All

electronic failures are considered hazardous. For more information, see document no. 8015532.

### Interfaces

---

Electrical interface:	SSI/Gray
Interface signals:	Clock +, Clock -, Data +, Data-
Clock frequency:	1 MHz <sup>1)</sup>
SET (electronic adjustment):	H-active (L ≡ 0 - 1,5 V, H ≡ 2,0 - Us V)
CW/CCW (counting sequence when turning):	L-active (L ≡ 0 - 1,5 V, H ≡ 2,0 - Us V)

<sup>1)</sup>

### Ambient data

---

EMC:	(according to EN 61000-6-2 and EN 61000-6-3) <sup>1)</sup>
Enclosure rating:	IP 65 (according to IEC 60529), shaft side, IP 67 (according to IEC 60529), housing side <sup>2)</sup>
Permissible relative humidity:	90 % (condensation of the optical scanning not permitted)
Working temperature range:	0 °C ... +85 °C
Storage temperature range:	-40 °C ... +100 °C, without package
Resistance to shocks:	50 g, 6 ms (according to EN 60068-2-27)
Resistance to vibration:	20 g, 10 Hz ... 2,000 Hz (according to EN 60068-2-6)

<sup>1)</sup> <sup>2)</sup> With mating connector fitted

## Dimensional drawing

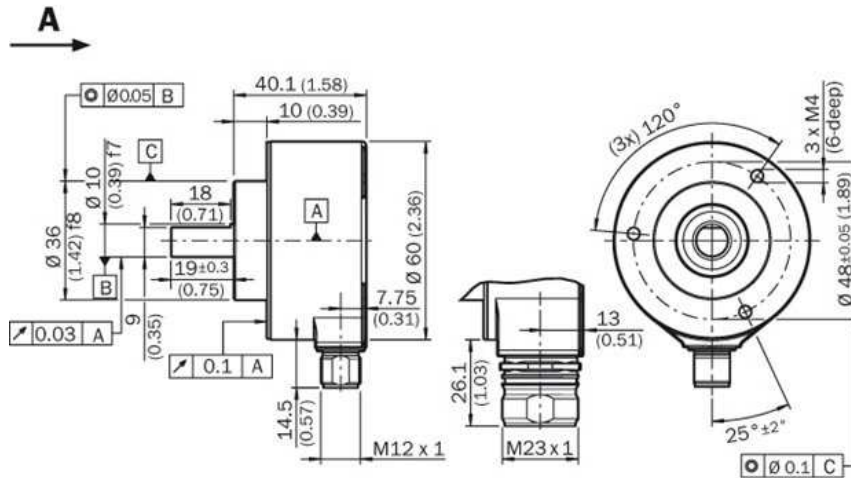

## PIN assignment

### Connector M23, 12 pin

SSI/Gray

Pin	Signal	Explanation
1	GND	Ground connection
2	Data+	Interface signals
3	Clock+	Interface signals
4	N.C.	Not connected
5	N.C.	Not connected
6	N.C.	Not connected
7	N.C.	Not connected
8	V <sub>L</sub>	Supply voltage
9	SET	Electronic adjustment
10	Data-	Interface signals
11	Clock-	Interface signals
12	CW/CCW	Counting sequence when turning
	Screen	Screen on the encoder side connected to the housing. On the control side connected to earth.

### Connector M23, 12 pin and cable outlet, cable 12-core

SSI/Gray + Incremental

Pin	Color wires	Signal	Explanation
1	Red	V <sub>L</sub>	Supply voltage
2	Blue	GND	Ground connection
3	Yellow	Clock+	Interface signal
4	White	Data+	Interface signal
5	Orange	SET	Electronic adjustment
6	Brown	Data-	Interface signal
7	Violet	Clock-	Interface signal
8	Black	~ B	Signal line
9	Orange/black	CW/CCW	Counting sequence when turning
10	Green	A	Signal line
11	Gray	A	Signal line
12	Pink	B	Signal line
	Screen		Screen on the encoder side connected to the housing. On the control side connected to earth.

### Connector M23, 12 pin and cable outlet, cable 12-core

SSI/Gray + Sin/Cos

Pin	Color wires	Signal	Explanation
1	Red	V <sub>L</sub>	Supply voltage
2	Blue	GND	Ground connection
3	Yellow	Clock+	Interface signal
4	White	Data+	Interface signal
5	Orange	SET	Electronic adjustment
6	Brown	Data-	Interface signal
7	Violet	Clock-	Interface signal
8	Black	Sin	Signal line
9	Orange/black	CW/CCW	Counting sequence when turning
10	Green	Cos	Signal line
11	Gray	Cos+	Signal line
12	Pink	Sin+	Signal line
	Screen		Screen on the encoder side connected to the housing. On the control side connected to earth.

# Signalausgänge

## SSI data format singleturn



### Bit 1-18: Position Bits

- LSD: Least significant Bit
- MSB: Most significant Bit

### Bit 19-21: Error Bits

- ERRDIG: Failure message about speed. If this failure occurs during the position building procedure it will be indicated by the ERRDIG-Bit.
- ERRSL: Light source monitoring failure.
- ERRSYNC: Contamination of the disc or scanning system. During the determination of the position, an error has occurred since the last SSI transmission. The error bit will be deleted during the next data transmission.

### The evaluation of the error bits has to be realized in the PLC.

The provided error bits don't have to be used by the PLC compulsorily.

### Example

If the resolution of the absolute encoder is set on 13 bits, 16 bits are provided by the encoder: 13 data bits and 3 error bits. If the PLC is not able to evaluate the error bits, the PLC has to be set on a resolution of 13 bits. Then the error bits have to be masked out by the PLC.

## SSI data format multiturn

### 30 Bits

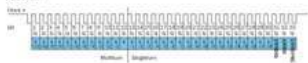

- Bit 1-12: Position Bits multiturn
- Bit 13-30: Position Bits singleturn
- Bit 31-33: Error Bits

### 27 Bits

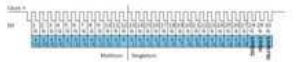

- Bit 1-12: Position Bits multiturn
- Bit 13-27: Position Bits singleturn
- Bit 28-30: Error Bits

### Error Bits

- ERRDIG: Failure message about speed. If this failure occurs during the position building procedure it will be indicated by the ERRDIG-Bit.
- ERRSL: Light source monitoring failure.
- ERRSYNC: Contamination of the disc or scanning system. During the determination of the position, an error has occurred since the last SSI transmission. The error bit will be deleted during the next data transmission.

### The evaluation of the error bits has to be realized in the PLC.

The provided error bits don't have to be used by the PLC compulsorily. The multiturn resolution is fixed on 12 bits.

### Example

If the resolution of the absolute encoder is set on 27 bits, 30 bits are provided by the encoder: 27 data bits and 3 error bits. If the PLC is not able to evaluate the error bits, the PLC has to be set on a resolution of 27 bits. Then the error bits have to be masked out by the PLC.

# Drehzahlbetrachtung

## Speed consideration (n)

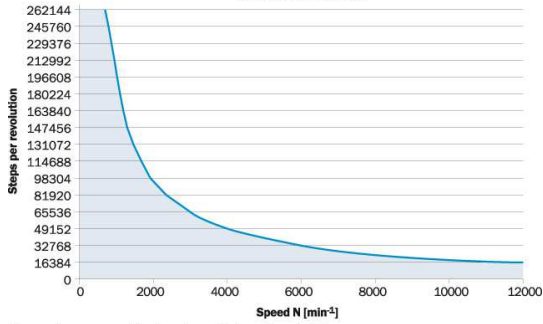

The maximum speed is also dependent on the shaft type.

# Signalausgänge

## SSI data format singleturn



### Bit 1-18: Position Bits

- LSD: Least significant Bit
- MSB: Most significant Bit

### Bit 19-21: Error Bits

- ERRDIG: Failure message about speed. If this failure occurs during the position building procedure it will be indicated by the ERRDIG-Bit.
- ERRSL: Light source monitoring failure.
- ERRSYNC: Contamination of the disc or scanning system. During the determination of the position, an error has occurred since the last SSI transmission. The error bit will be deleted during the next data transmission.

### The evaluation of the error bits has to be realized in the PLC.

The provided error bits don't have to be used by the PLC compulsorily.

### Example

If the resolution of the absolute encoder is set on 13 bits, 16 bits are provided by the encoder: 13 data bits and 3 error bits. If the PLC is not able to evaluate the error bits, the PLC has to be set on a resolution of 13 bits. Then the error bits have to be masked out by the PLC.

## SSI data format multiturn

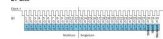

- Bit 1-12: Position Bits multiturn
- Bit 13-30: Position Bits singleturn
- Bit 31-33: Error Bits

### 27 Bits



- Bit 1-12: Position Bits multiturn
- Bit 13-27: Position Bits singleturn
- Bit 28-30: Error Bits

### Error Bits

- ERRDIG: Failure message about speed. If this failure occurs during the position building procedure it will be indicated by the ERRDIG-Bit.
- ERRSL: Light source monitoring failure.
- ERRSYNC: Contamination of the disc or scanning system. During the determination of the position, an error has occurred since the last SSI transmission. The error bit will be deleted during the next data transmission.

### The evaluation of the error bits has to be realized in the PLC.

The provided error bits don't have to be used by the PLC compulsorily. The multiturn resolution is fixed on 12 bits.

### Example

If the resolution of the absolute encoder is set on 27 bits, 30 bits are provided by the encoder: 27 data bits and 3 error bits. If the PLC is not able to evaluate the error bits, the PLC has to be set on a resolution of 27 bits. Then the error bits have to be masked out by the PLC.

# Interfaces

## Electrical interfaces sine 0.5 V<sub>r</sub>

Power supply Output

±5...±15 V ±5...±15 V<sub>r</sub>

Signal before differential generation at load 120 Ω at U<sub>r</sub> = 5 V

Signal diagram for absolute rotation of the shaft looking in direction "A" (shaft)

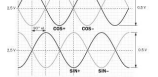

Electrical signal Sin, Cos, Cos, Dec Signal before differential generation at load 120 Ω

Signal after differential generation at load 120 Ω at U<sub>r</sub> = 5 V

Signal diagram for absolute rotation of the shaft looking in direction "A" (shaft)

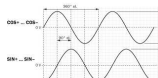

Incremental pulse diagram for absolute rotation of the shaft looking in direction "A", see dimensional drawing



**Australia**

Phone +61 3 9457 0600  
1800 33 48 02 – tollfree  
E-Mail sales@sick.com.au

**Belgium/Luxembourg**

Phone +32 (0)2 466 55 66  
E-Mail info@sick.be

**Brasil**

Phone +55 11 3215-4900  
E-Mail marketing@sick.com.br

**Canada**

Phone +1 905 771 14 44  
E-Mail information@sick.com

**Česká republika**

Phone +420 2 57 91 18 50  
E-Mail sick@sick.cz

**China**

Phone +86 4000 121 000  
E-Mail info.china@sick.net.cn  
Phone +852-2153 6300  
E-Mail ghk@sick.com.hk

**Danmark**

Phone +45 45 82 64 00  
E-Mail sick@sick.dk

**Deutschland**

Phone +49 211 5301-301  
E-Mail info@sick.de

**España**

Phone +34 93 480 31 00  
E-Mail info@sick.es

**France**

Phone +33 1 64 62 35 00  
E-Mail info@sick.fr

**Great Britain**

Phone +44 (0)1727 831121  
E-Mail info@sick.co.uk

**India**

Phone +91-22-4033 8333  
E-Mail info@sick-india.com

**Israel**

Phone +972-4-6881000  
E-Mail info@sick-sensors.com

**Italia**

Phone +39 02 27 43 41  
E-Mail info@sick.it

**Japan**

Phone +81 (0)3 5309 2112  
E-Mail support@sick.jp

**Magyarország**

Phone +36 1 371 2680  
E-Mail office@sick.hu

**Nederland**

Phone +31 (0)30 229 25 44  
E-Mail info@sick.nl

**Norge**

Phone +47 67 81 50 00  
E-Mail sick@sick.no

**Österreich**

Phone +43 (0)22 36 62 28 8-0  
E-Mail office@sick.at

**Polska**

Phone +48 22 837 40 50  
E-Mail info@sick.pl

**România**

Phone +40 356 171 120  
E-Mail office@sick.ro

**Russia**

Phone +7-495-775-05-30  
E-Mail info@sick.ru

**Schweiz**

Phone +41 41 619 29 39  
E-Mail contact@sick.ch

**Singapore**

Phone +65 6744 3732  
E-Mail sales.gsg@sick.com

**Slovenija**

Phone +386 (0)1-47 69 990  
E-Mail office@sick.si

**South Africa**

Phone +27 11 472 3733  
E-Mail info@sickautomation.co.za

**South Korea**

Phone +82 2 786 6321/4  
E-Mail info@sickkorea.net

**Suomi**

Phone +358-9-25 15 800  
E-Mail sick@sick.fi

**Sverige**

Phone +46 10 110 10 00  
E-Mail info@sick.se

**Taiwan**

Phone +886 2 2375-6288  
E-Mail sales@sick.com.tw

**Türkiye**

Phone +90 (216) 528 50 00  
E-Mail info@sick.com.tr

**United Arab Emirates**

Phone +971 (0) 4 88 65 878  
E-Mail info@sick.ae

**USA/México**

Phone +1(952) 941-6780  
1 (800) 325-7425 – tollfree  
E-Mail info@sickusa.com

More representatives and agencies  
at [www.sick.com](http://www.sick.com)