



Short range distance sensors (displacement) DT20

DT20-P130B2570



Model Name > **DT20-P130B2570**
Part No. > **1040008**



At a glance

- Different measuring ranges from 90 mm ... 1,000 mm
- Repeatability up to ± 1.5 mm
- Infrared sender, which is not visible to the human eye
- Analog and switching output provide distance and out of range information
- Plug and play sensor that is factory-programmed based on customer specifications
- High output rate - distance outputs are provided every millisecond
- Rugged, metal housing

Your benefits

- Fast, easy commissioning based on customer-specific presets saves time
- Tamper-proof sensor concept ensures high machine availability
- Inconspicuous and therefore non distracting by use of infrared light
- High ambient light immunity increases machine availability
- Solid, IP 67-rated metal housing permits operation in harsh environments, making the sensor suitable for a wide range of applications



Performance

Measurement range:	250 mm ... 700 mm, 18 % ... 90 % remission ¹⁾
Resolution ²⁾ :	1 mm/2 mm
Repeatability ³⁾ :	± 1.5 mm/ ± 3 mm
Response time ⁴⁾ :	10 ms/15 ms
Light source:	LED, infrared
Typ. light spot size (distance):	15 mm x 15 mm (at 1 m)
Additional function:	Customer specific scaled measuring range, Plug & Play, Switching output to monitor the measuring range
Accuracy::	± 4 mm ^{5) 6)}
Laser service life (MTTF at 25 °C):	100,000 h
Output time:	1 ms

¹⁾ On 6 % remission the maximal measurable distance is 820 mm ^{2) 4)} Depending on measurement range: 90 ... 600 mm/> 600 mm. ³⁾ 18 % ... 90 % remission ^{5) 6)} % ... 90 % remission ⁶⁾ ± 4 mm u to 600 mm; $\leq \pm 7$ mm for distances larger < 600 mm; refer to accuracy diagram

Interfaces

Output type ¹⁾ :	1 x PNP (100 mA)
Analog output:	1 x 4 mA ... 20 mA ($\leq 300 \Omega$)

1) PNP: HIGH = V_S - (< 2 V) / LOW = 0 V

Mechanics/electronics

Connection type:	Male connector, M12, 5-pin
Supply voltage V_S ¹⁾ :	DC 10 V ... 30 V
Power consumption ²⁾ :	≤ 1.5 W
Warm-up time:	≤ 30 min
Indication:	2 x LED
Weight:	135 g
Housing material:	Metal housing with PMMA lens
Initialization time:	≤ 250 ms
Ripple:	≤ 5 Vpp ³⁾

1) Limit values, reverse-polarity protected, operation in short-circuit protected network: max. 8 A ²⁾ Without load ³⁾ May not fall short of or exceed V_S tolerances

Ambient data

Enclosure rating:	IP 65
Protection class:	II
Ambient temperature:	Operation: -25 ... +55 °C, Storage: -40 ... +75 °C
Temperature drift:	0.25 mm/K
Vibration resistance:	EN 60068-2-6 / EN 60068-2-64
Shock resistance:	EN 60068-2-27

Dimensional drawing

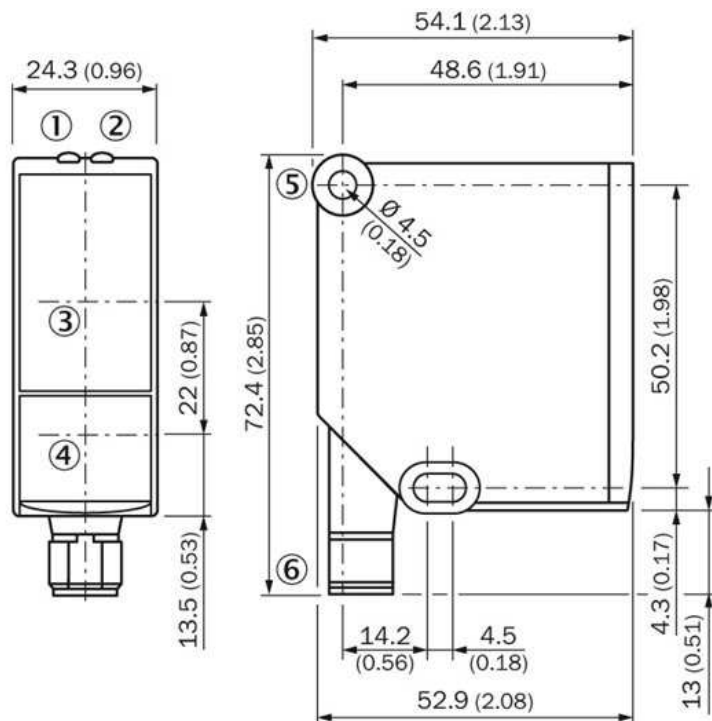

- [1] Status indicator power on (green)
- [2] Status indicator switching output (orange)
- [3] Optical axis, receiver
- [4] Optical axis, sender
- [5] Mounting hole
- [6] connector M12, 5-pin

Connection type

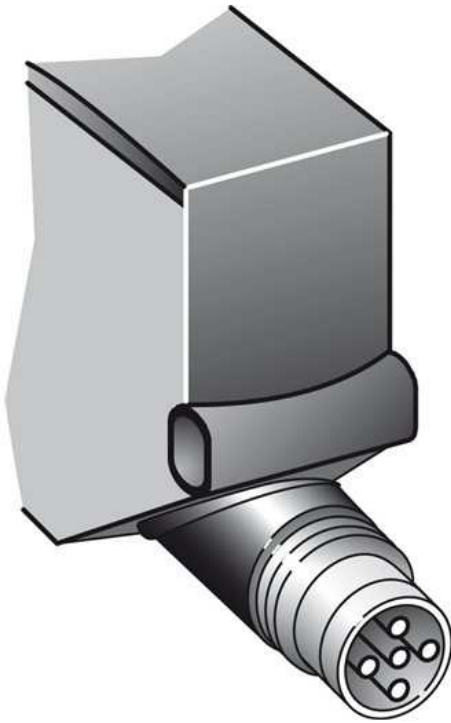

Connection diagram

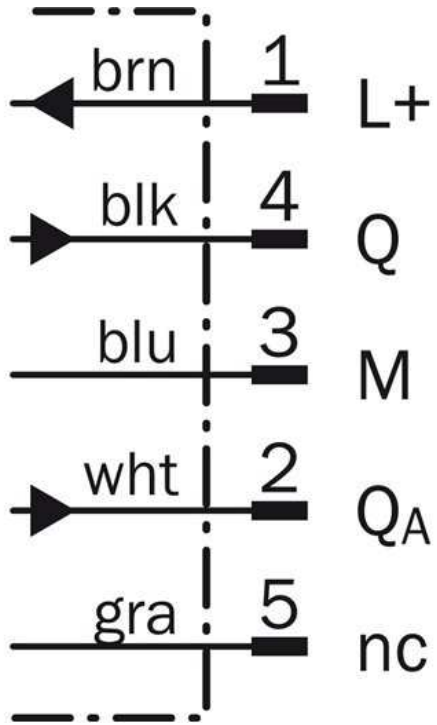

Australia

Phone +61 3 9457 0600
1800 33 48 02 – tollfree
E-Mail sales@sick.com.au

Belgium/Luxembourg

Phone +32 (0)2 466 55 66
E-Mail info@sick.be

Brasil

Phone +55 11 3215-4900
E-Mail marketing@sick.com.br

Canada

Phone +1 905 771 14 44
E-Mail information@sick.com

Česká republika

Phone +420 2 57 91 18 50
E-Mail sick@sick.cz

China

Phone +86 4000 121 000
E-Mail info.china@sick.net.cn
Phone +852-2153 6300
E-Mail ghk@sick.com.hk

Danmark

Phone +45 45 82 64 00
E-Mail sick@sick.dk

Deutschland

Phone +49 211 5301-301
E-Mail info@sick.de

España

Phone +34 93 480 31 00
E-Mail info@sick.es

France

Phone +33 1 64 62 35 00
E-Mail info@sick.fr

Great Britain

Phone +44 (0)1727 831121
E-Mail info@sick.co.uk

India

Phone +91-22-4033 8333
E-Mail info@sick-india.com

Israel

Phone +972-4-6881000
E-Mail info@sick-sensors.com

Italia

Phone +39 02 27 43 41
E-Mail info@sick.it

Japan

Phone +81 (0)3 5309 2112
E-Mail support@sick.jp

Magyarország

Phone +36 1 371 2680
E-Mail office@sick.hu

Nederland

Phone +31 (0)30 229 25 44
E-Mail info@sick.nl

Norge

Phone +47 67 81 50 00
E-Mail sick@sick.no

Österreich

Phone +43 (0)22 36 62 28 8-0
E-Mail office@sick.at

Polska

Phone +48 22 837 40 50
E-Mail info@sick.pl

România

Phone +40 356 171 120
E-Mail office@sick.ro

Russia

Phone +7-495-775-05-30
E-Mail info@sick.ru

Schweiz

Phone +41 41 619 29 39
E-Mail contact@sick.ch

Singapore

Phone +65 6744 3732
E-Mail sales.gsg@sick.com

Slovenija

Phone +386 (0)1-47 69 990
E-Mail office@sick.si

South Africa

Phone +27 11 472 3733
E-Mail info@sickautomation.co.za

South Korea

Phone +82 2 786 6321/4
E-Mail info@sickkorea.net

Suomi

Phone +358-9-25 15 800
E-Mail sick@sick.fi

Sverige

Phone +46 10 110 10 00
E-Mail info@sick.se

Taiwan

Phone +886 2 2375-6288
E-Mail sales@sick.com.tw

Türkiye

Phone +90 (216) 528 50 00
E-Mail info@sick.com.tr

United Arab Emirates

Phone +971 (0) 4 88 65 878
E-Mail info@sick.ae

USA/México

Phone +1(952) 941-6780
1 (800) 325-7425 – tollfree
E-Mail info@sickusa.com

More representatives and agencies
at www.sick.com