



Mid range distance sensors Dx60, DT60

DT60-P111B0230



Model Name > [DT60-P111B0230](#)
Part No. > [1040528](#)



At a glance

- Measuring range: up to 5,300 mm
- Analog output with 4 mA ... 20 mA or 0 V ... 10 V
- Customer-specific, pre-programmed versions available for fast system integration
- Time-of-flight technology for reliable results
- Visible red laser light
- Power-on LED

Your benefits

- Measuring range of up to 5,300 mm with analog and switching outputs ensure high application flexibility
- All versions, even infrared variants with supplemental light, utilize red laser for fast and precise alignment
- Tough, lightweight housing withstands harsh environments
- Easy one-button teach-in offers fast commissioning
- High switching and measuring accuracy increase process reliability, ensuring higher productivity and better quality
- Pre-set plug and play versions ensure immediate commissioning, eliminating any sensor teach-in



Performance

Measurement range:	200 mm ... 2,800 mm, 6 % remission 200 mm ... 3,000 mm, 18 % remission 200 mm ... 3,000 mm, 90 % remission
Resolution ¹⁾ :	1.5 mm, Teach resolution
Repeatability ²⁾ :	8 mm
Accuracy ³⁾ :	± 10 mm
Response time ⁴⁾ :	20 ms ... 150 ms
Light source:	Laser, red
Typ. light spot size (distance):	10 mm x 10 mm (at 2 m)
Additional function:	Switching output invertible/invertible analog output Plug & Play version
Laser class:	2 (EN 60825-1)
Laser service life (MTTF at 25 °C):	50,000 h

1) 2) 3) 6 % ... 90 % remission 4) Adaptive, dependig on level of remission

Interfaces

Analog output:	4 mA ... 20 mA
Resolution analog output:	12 bit
Output type ¹⁾ ; ²⁾ :	1 x PNP (100 mA)
Multifunctional input (MF):	1x Laser off

¹⁾ Output Q short-circuit protected ²⁾ PNP: HIGH = $V_S - (< 2 V)$ /LOW = 0 V

Mechanics/electronics

Supply voltage V_S ¹⁾ :	DC 11 V ... 30 V
Ripple ²⁾ :	$\leq 5 V_{pp}$
Power consumption ³⁾ :	$\leq 3 W$
Warm-up time:	$\leq 30 \text{ min}$
Connection type:	Male connector, M12, 5-pin
Weight:	202 g

¹⁾ Limit values, reverse-polarity protected, operation in short-circuit protected network: max. 8 A ²⁾ May not fall short of or exceed V_S tolerances ³⁾ Without load

Ambient data

Enclosure rating:	IP 67
Protection class:	II
Ambient temperature:	Operation: -25 ... +55 °C, Storage: -25 ... +75 °C
Electromagnetic compatibility (EMC):	EN 61000-6-2/EN 60947-5-2

Dimensional drawing

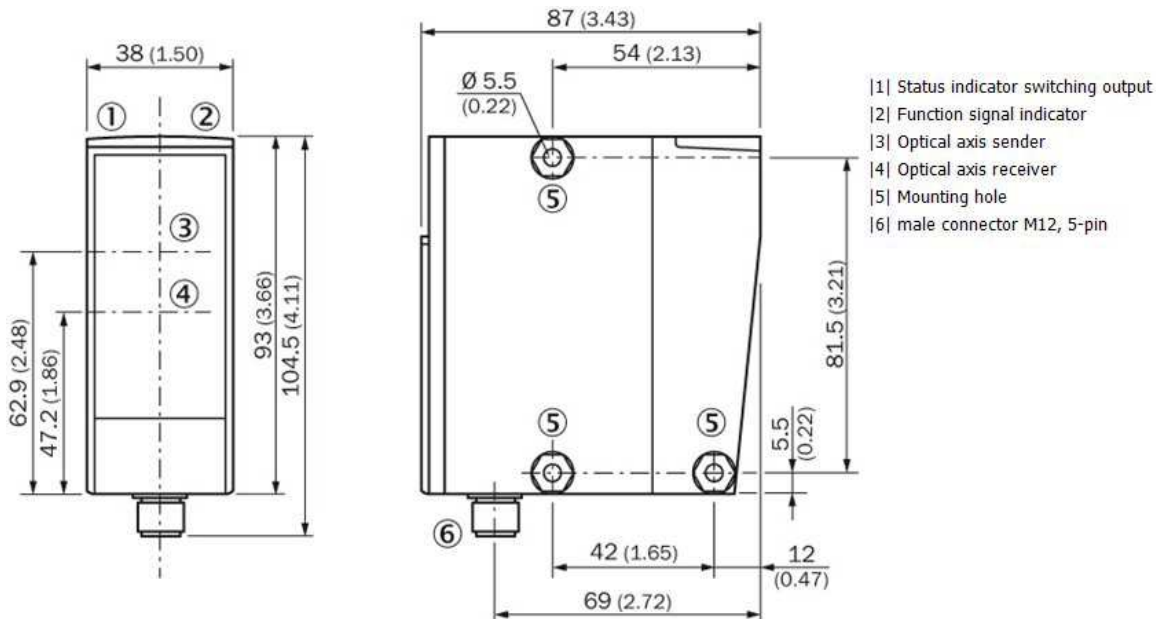

Adjustment possible

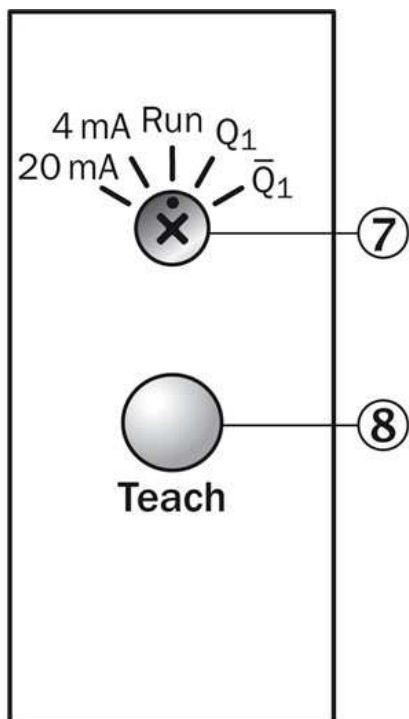

|7| rotary switch
|8| Control element

Connection type

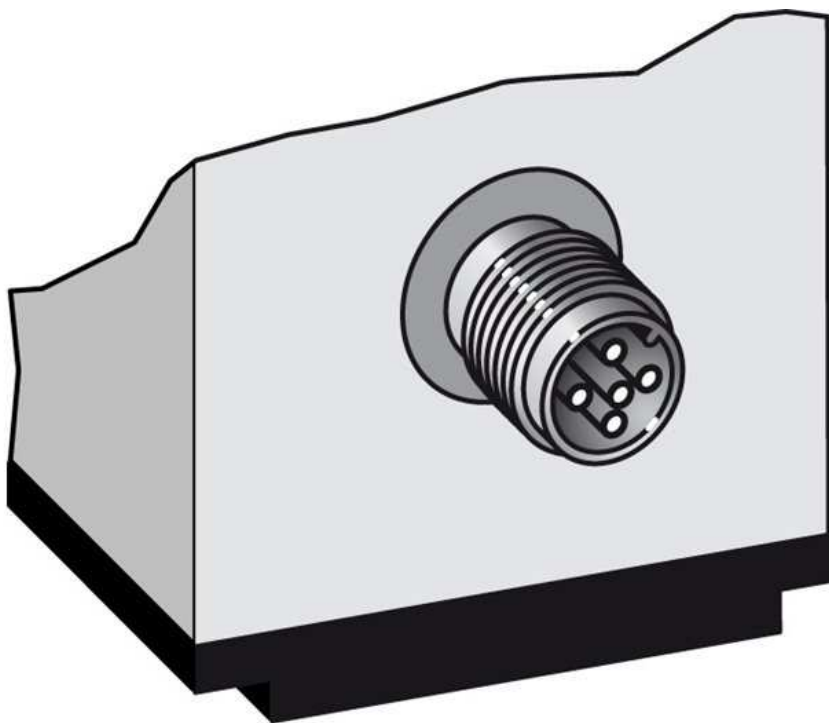

Connection diagram

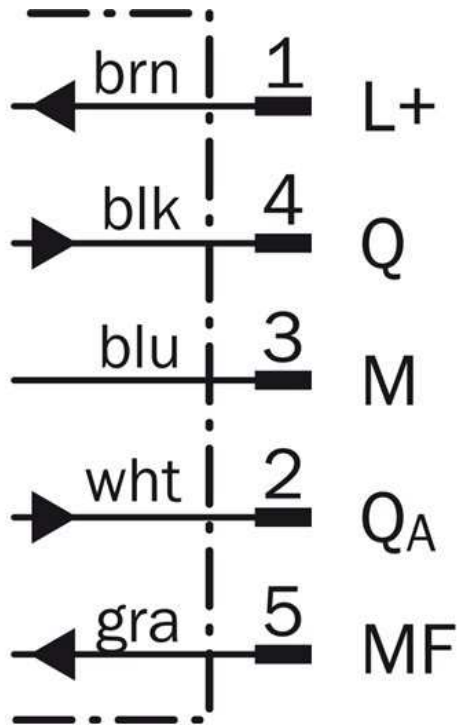

Plug & Play: How to choose different measurement ranges by the type code (4 mA ... 20 mA)

The DT60 can be factory scaled for customer specific measurement ranges based on the type code.

The type code is: "DT60-xx11Bbbee". The „bbee“-part defines the measurement range as follows:

bb (begin) = distance value chosen by the customer to be output with 4 mA. The "bb"-value is defined in dm.

ee (end) = distance value chosen by the customer to be output with 20 mA. The "ee"-value is defined in dm.

Be aware

There is a minimum difference between "bb" and "ee" of at least 3 units (300 mm) (e.g. bb = 02 → ee ≥ 05)

Range of values

02 ... 53 = 200 mm ... 5,300 mm, any configuration within this range can be chosen (e.g. 0234, 4053 etc.).

Examples

Model name	Description
DT60-P111B1234	DT60, switching output PNP, measurement range 1,200 mm ... 3,400 mm (4 mA @ 12 dm ... 20 mA @ 34 dm)
DT60-N111B0945	DT60, switching output NPN, measurement range 900 mm ... 4,500 mm (4 mA @ 9 dm ... 20 mA @ 45 dm)
DT60-P111B4238	DT60, switching output PNP, measurement range 4,200 mm ... 3,800 mm (inverted measuring area) (4 mA @ 42 dm ... 20 mA @ 38 dm)

ee > bb

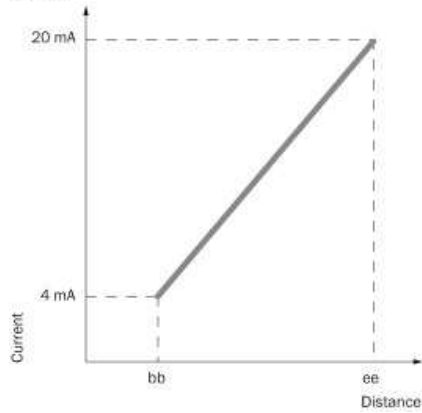

bb > ee (inverted measuring area)

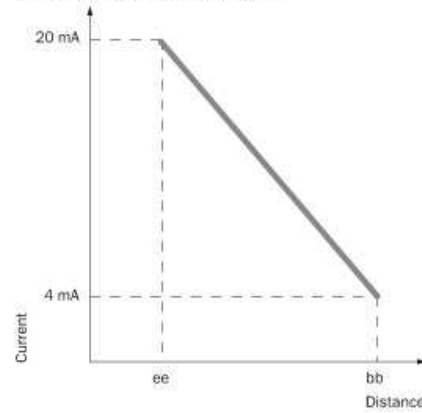

Australia

Phone +61 3 9457 0600
1800 33 48 02 – tollfree
E-Mail sales@sick.com.au

Belgium/Luxembourg

Phone +32 (0)2 466 55 66
E-Mail info@sick.be

Brasil

Phone +55 11 3215-4900
E-Mail marketing@sick.com.br

Canada

Phone +1 905 771 14 44
E-Mail information@sick.com

Česká republika

Phone +420 2 57 91 18 50
E-Mail sick@sick.cz

China

Phone +86 4000 121 000
E-Mail info.china@sick.net.cn
Phone +852-2153 6300
E-Mail ghk@sick.com.hk

Danmark

Phone +45 45 82 64 00
E-Mail sick@sick.dk

Deutschland

Phone +49 211 5301-301
E-Mail info@sick.de

España

Phone +34 93 480 31 00
E-Mail info@sick.es

France

Phone +33 1 64 62 35 00
E-Mail info@sick.fr

Great Britain

Phone +44 (0)1727 831121
E-Mail info@sick.co.uk

India

Phone +91-22-4033 8333
E-Mail info@sick-india.com

Israel

Phone +972-4-6881000
E-Mail info@sick-sensors.com

Italia

Phone +39 02 27 43 41
E-Mail info@sick.it

Japan

Phone +81 (0)3 5309 2112
E-Mail support@sick.jp

Magyarország

Phone +36 1 371 2680
E-Mail office@sick.hu

Nederland

Phone +31 (0)30 229 25 44
E-Mail info@sick.nl

Norge

Phone +47 67 81 50 00
E-Mail sick@sick.no

Österreich

Phone +43 (0)22 36 62 28 8-0
E-Mail office@sick.at

Polska

Phone +48 22 837 40 50
E-Mail info@sick.pl

România

Phone +40 356 171 120
E-Mail office@sick.ro

Russia

Phone +7-495-775-05-30
E-Mail info@sick.ru

Schweiz

Phone +41 41 619 29 39
E-Mail contact@sick.ch

Singapore

Phone +65 6744 3732
E-Mail sales.gsg@sick.com

Slovenija

Phone +386 (0)1-47 69 990
E-Mail office@sick.si

South Africa

Phone +27 11 472 3733
E-Mail info@sickautomation.co.za

South Korea

Phone +82 2 786 6321/4
E-Mail info@sickkorea.net

Suomi

Phone +358-9-25 15 800
E-Mail sick@sick.fi

Sverige

Phone +46 10 110 10 00
E-Mail info@sick.se

Taiwan

Phone +886 2 2375-6288
E-Mail sales@sick.com.tw

Türkiye

Phone +90 (216) 528 50 00
E-Mail info@sick.com.tr

United Arab Emirates

Phone +971 (0) 4 88 65 878
E-Mail info@sick.ae

USA/México

Phone +1(952) 941-6780
1 (800) 325-7425 – tollfree
E-Mail info@sickusa.com

More representatives and agencies
at www.sick.com