



Inductive proximity sensors
Cylindrical threaded housing, IME30

IME30-10BPOZW2S



Model Name > [IME30-10BPOZW2S](#)
Part No. > [1041004](#)



At a glance

- Size M30
- IP 67 enclosure rating
- Operating temperature from -25° C to +75° C

Your benefits

- Reduced machine downtime
- Reduced mechanical damage
- Fewer maintenance costs due to longer service life
- High resistance to shock and vibrations



Features

Design:	Cylindrical
Thread size:	M30 x 1.5
Sensing range Sn:	10 mm
Assured sensing range Sa:	8.1 mm
Installation type:	Flush
Switching frequency:	500 Hz
Output type:	PNP
Output function:	NC
Electrical wiring:	DC 3-wire
Enclosure rating:	IP 67 ¹⁾
Connection type:	Cable, 3-wire, 2 m
Housing:	Standard

¹⁾ According to EN 60529

Mechanics/electronics

Supply voltage:	10 V DC ... 30 V DC
Ripple:	≤ 10 %
Voltage drop:	≤ 2 V
Power consumption:	≤ 10 mA ¹⁾
Time delay before availability:	≤ 125 ms
Hysteresis:	5 % ... 15 %
Repeatability:	≤ 2 % ^{2) 3)}
Temperature drift (of Sr):	± 10 %
EMC:	According to EN 60947-5-2

Output current I _a :	≤ 200 mA
Cable material:	PVC
Short-circuit protection:	✓
Reverse polarity protection:	✓
Power-up pulse protection:	✓
Shock and vibration resistance:	30 g, 11 ms/10 Hz ... 55 Hz, 1 mm
Ambient operating temperature:	-25 °C ... 75 °C
Housing material:	Metal, Nickel-plated brass
Housing cap material:	Plastic, PA6
Housing length:	70 mm
Thread length:	54 mm
Tightening torque, max.:	100 Nm

1) Without load 2) U_b and T_a constant 3) Of Sr

Reduction factors

Note:	The values are reference values which may vary
Carbon steel St37 (Fe):	1
Stainless steel (V2A, 304):	Ca. 0.8
Copper (Cu):	Ca. 0.4
Aluminum (Al):	Ca. 0.45
Brass (Br):	Ca. 0.4

Installation note

B:	30 mm
C:	30 mm
D:	30 mm
F:	80 mm
Remark:	Associated graphic see "Installation"

Installation note



Dimensional drawing

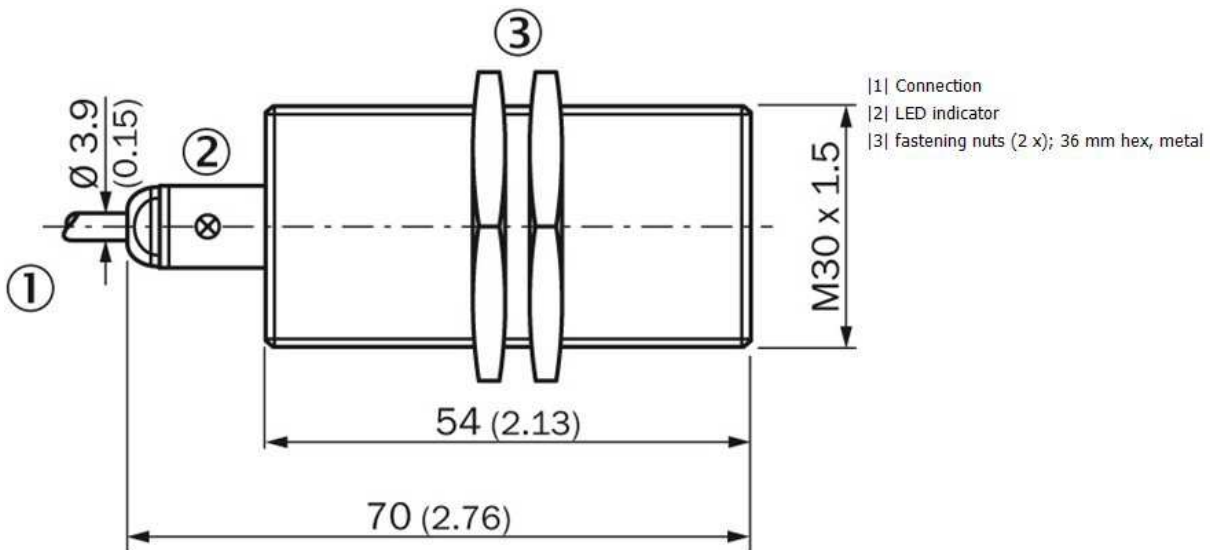

Connection diagram

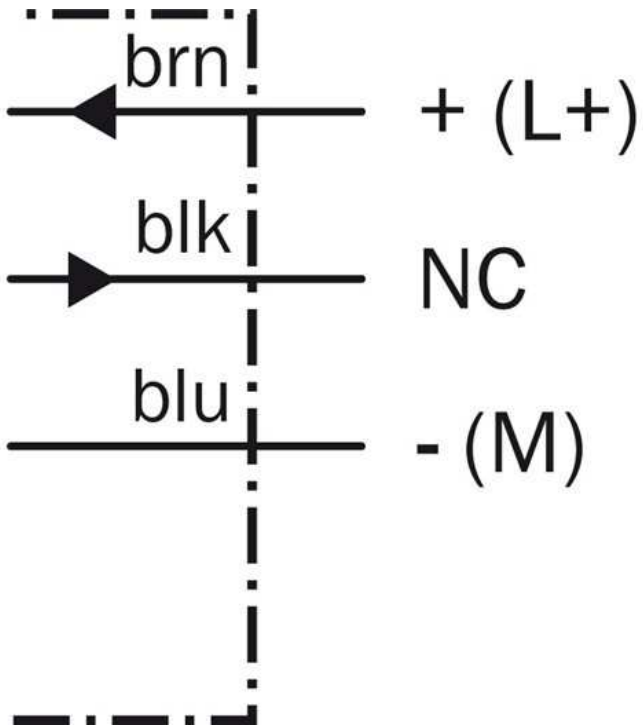

Connection type



Australia

Phone +61 3 9457 0600
1800 33 48 02 – tollfree
E-Mail sales@sick.com.au

Belgium/Luxembourg

Phone +32 (0)2 466 55 66
E-Mail info@sick.be

Brasil

Phone +55 11 3215-4900
E-Mail marketing@sick.com.br

Canada

Phone +1 905 771 14 44
E-Mail information@sick.com

Česká republika

Phone +420 2 57 91 18 50
E-Mail sick@sick.cz

China

Phone +86 4000 121 000
E-Mail info.china@sick.net.cn
Phone +852-2153 6300
E-Mail ghk@sick.com.hk

Danmark

Phone +45 45 82 64 00
E-Mail sick@sick.dk

Deutschland

Phone +49 211 5301-301
E-Mail info@sick.de

España

Phone +34 93 480 31 00
E-Mail info@sick.es

France

Phone +33 1 64 62 35 00
E-Mail info@sick.fr

Great Britain

Phone +44 (0)1727 831121
E-Mail info@sick.co.uk

India

Phone +91-22-4033 8333
E-Mail info@sick-india.com

Israel

Phone +972-4-6881000
E-Mail info@sick-sensors.com

Italia

Phone +39 02 27 43 41
E-Mail info@sick.it

Japan

Phone +81 (0)3 5309 2112
E-Mail support@sick.jp

Magyarország

Phone +36 1 371 2680
E-Mail office@sick.hu

Nederland

Phone +31 (0)30 229 25 44
E-Mail info@sick.nl

Norge

Phone +47 67 81 50 00
E-Mail sick@sick.no

Österreich

Phone +43 (0)22 36 62 28 8-0
E-Mail office@sick.at

Polska

Phone +48 22 837 40 50
E-Mail info@sick.pl

România

Phone +40 356 171 120
E-Mail office@sick.ro

Russia

Phone +7-495-775-05-30
E-Mail info@sick.ru

Schweiz

Phone +41 41 619 29 39
E-Mail contact@sick.ch

Singapore

Phone +65 6744 3732
E-Mail sales.gsg@sick.com

Slovenija

Phone +386 (0)1-47 69 990
E-Mail office@sick.si

South Africa

Phone +27 11 472 3733
E-Mail info@sickautomation.co.za

South Korea

Phone +82 2 786 6321/4
E-Mail info@sickkorea.net

Suomi

Phone +358-9-25 15 800
E-Mail sick@sick.fi

Sverige

Phone +46 10 110 10 00
E-Mail info@sick.se

Taiwan

Phone +886 2 2375-6288
E-Mail sales@sick.com.tw

Türkiye

Phone +90 (216) 528 50 00
E-Mail info@sick.com.tr

United Arab Emirates

Phone +971 (0) 4 88 65 878
E-Mail info@sick.ae

USA/México

Phone +1(952) 941-6780
1 (800) 325-7425 – tollfree
E-Mail info@sickusa.com

More representatives and agencies
at www.sick.com