



Bar code scanners
CLV63x / CLV631 / Mid Range

CLV631-3000



Model Name > [CLV631-3000](#)
Part No. > [1041984](#)



At a glance

- Integrated pushbuttons for auto setup and reading diagnostics
- Integrated LED bar graph
- CAN, Ethernet TCP/IP, PROFINET, and EtherNet/IP available on board, no additional gateway needed (depending on variant)
- Enhanced SMART code reconstruction technology
- Flexible sorting, filtering, and logical functions
- Advanced, easy-to-use SOPAS configuration software
- High scanning frequency of up to 1,200 Hz
- Advanced remote diagnostics and network monitoring capabilities available over Ethernet

Your benefits

- Intelligent auto setup and multi-function pushbuttons save time during commissioning
- Easily execute firmware updates using the microSD memory card: no need for a PC
- Enhanced SMART technology reads damaged and partially obscured codes, increasing read rates
- Increased scanner intelligence enables sophisticated configuration of logical operations, reducing the control system programming effort. Data is then delivered in the desired format
- Real-time decoding at very high speeds
- Increased reading reliability due to high-performance computing power and a high scanning frequency



Features

Version:	Mid Range
Connection type:	Cable
Reading field:	Side (105 °)
Scanner design:	Raster scanner
Focus:	Fixed focus
Light source:	Visible red light (655 nm)
MTBF:	40,000 h
Laser class:	2 (EN 60825-1 (A2:2001-03))
Field of view:	≤ 50 °
Code resolution:	0.25 mm ... 0.5 mm

Reading distance:	74 mm ... 412 mm ¹⁾
Raster height, number of lines, at distance:	15 mm, 8, 185 mm
Heating:	Optional
Scanning frequency:	400 Hz ... 1,200 Hz

¹⁾ For details see reading field diagram

Performance

Bar code types:	Interleaved 2 of 5, All current code types, Codabar, Code 128, Code 39, Code 93, GS1 DataBar, GS1-128/EAN 128, MSI/Plessey, Pharmacode, Telepen, UPC/GTIN/EAN
Print ratio:	2:1 ... 3:1
No. of codes per scan:	1 ... 20 (Standard decoder), 1 ... 6 (SMART decoder)
No. of codes per reading interval:	1 ... 50 (auto-discriminating)
No. of characters per reading interval:	5,000, 500 (for multiplexer function in CAN operation)
No. of multiple readings:	1 ... 99

Interfaces

Serial (RS-232, RS-422/485):	✓
Remark (Serial (RS-232, RS-422/485)):	AUX (only RS-232)
Function (Serial (RS-232, RS-422/485)):	Host, AUX
Data transmission rate (Serial (RS-232, RS-422/485)):	2,400 Baud ... 115 kBaud, AUX: 57.6 kBaud
Ethernet:	-
Protocol (Ethernet):	PROFINET Dual Port (optional via external connection module CDF600-2), EtherCAT (optional via external connection module CDF600)
CAN bus:	✓
Function (CAN bus):	SICK CAN sensor network (Master/Slave, Multiplexer/Server)
Protocol (CAN bus):	CANopen, CSN (SICK CAN Sensor Network)
Data transmission rate (CAN bus):	20 kbit/s ... 1 Mbit/s
PROFIBUS DP:	✓
Remark (PROFIBUS DP):	Optional via external connection module (CDF600-2)
DeviceNet:	✓
Remark (DeviceNet):	Optional via external connection module (CDM + CMF)
Control elements:	2 buttons (choose and start/stop functions)
Memory card:	MicroSD memory card (flash card) 512 MB, optional
Switching inputs:	4 ("Sensor 1", "Sensor 2", 2 inputs via optional parameter storage CMC600 in CDB620/CDM420)
Switching outputs:	4 ("Result 1", "Result 2", 2 outputs via optional parameter storage CMC600 in CDB620/CDM420)
Reading pulse:	Auto pulse, CAN, Non-powered, "Sensor 1" switching input, Serial interface
Optical indicators:	6 LEDs (Ready, Result, laser, Data, CAN, LNK TX, Bar graph for displaying the reading rate percentage (10 LEDs))
Acoustic indicators:	Beeper/buzzer (can be switched off, can be allocated as a result indication function)
Configuration software:	SOPAS ET

Mechanics/electronics

Electrical connection:	1 x 15-pin D-Sub HD male connector (0.9 m)
Operating voltage:	18 V DC ... 30 V DC
Power consumption:	5 W
Housing:	Die-cast aluminum
Housing color:	Light blue (RAL 5012)

Front screen:	Glass
Enclosure rating:	IP 65 (EN 60529)
Protection class:	III (EN 61140)
Weight:	340 g, with connecting cable
Dimensions:	80 mm x 96 mm x 38 mm

Ambient data

Electromagnetic compatibility (EMC):	EN 61000-6-3 (2001-10)/EN 61000-6-2:2005
Vibration resistance:	EN 60068-2-6 (1995)
Shock resistance:	EN 60068-2-27 (1993)
Ambient operating temperature:	0 °C ... +40 °C
Storage temperature:	-20 °C ... +70 °C
Permissible relative humidity:	90 %, non-condensing
Bar code print contrast (PCS):	≥ 60 %
Ambient light immunity:	2,000 lx, on bar code

General notes

Note on use:	For Ethernet connection please use an Ethernet version of CLV6xx
--------------	--

Dimensional drawing

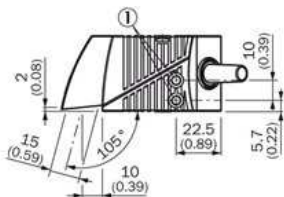

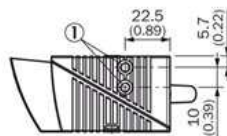
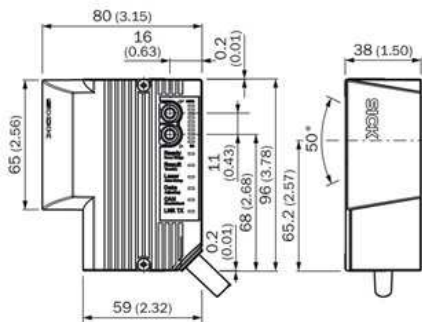

[1] M5 threaded mounting hole, 5.5 mm deep

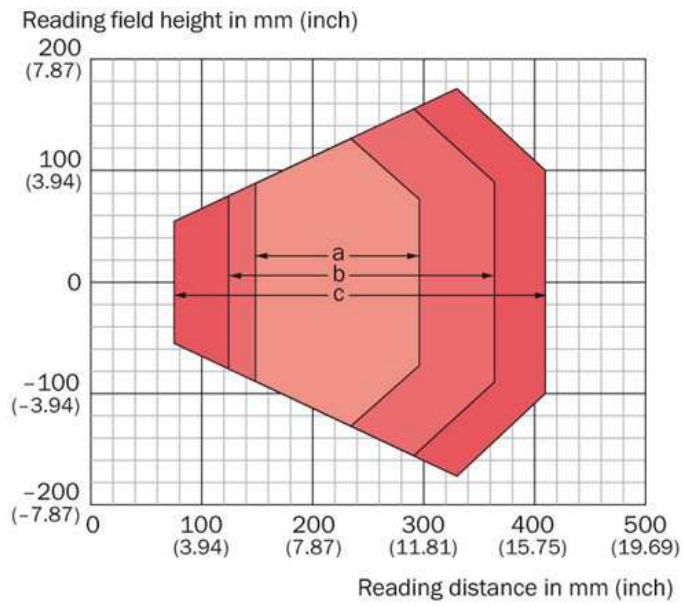

Reading field diagram



Resolution

- | | |
|---|---|
|  a: 0.25 mm (9.8 mil) |  b: 0.35 mm (13.8 mil) |
|  c: 0.50 mm (19.7 mil) | |

Australia

Phone +61 3 9457 0600
1800 33 48 02 – tollfree
E-Mail sales@sick.com.au

Belgium/Luxembourg

Phone +32 (0)2 466 55 66
E-Mail info@sick.be

Brasil

Phone +55 11 3215-4900
E-Mail marketing@sick.com.br

Canada

Phone +1 905 771 14 44
E-Mail information@sick.com

Česká republika

Phone +420 2 57 91 18 50
E-Mail sick@sick.cz

China

Phone +86 4000 121 000
E-Mail info.china@sick.net.cn
Phone +852-2153 6300
E-Mail ghk@sick.com.hk

Danmark

Phone +45 45 82 64 00
E-Mail sick@sick.dk

Deutschland

Phone +49 211 5301-301
E-Mail info@sick.de

España

Phone +34 93 480 31 00
E-Mail info@sick.es

France

Phone +33 1 64 62 35 00
E-Mail info@sick.fr

Great Britain

Phone +44 (0)1727 831121
E-Mail info@sick.co.uk

India

Phone +91-22-4033 8333
E-Mail info@sick-india.com

Israel

Phone +972-4-6881000
E-Mail info@sick-sensors.com

Italia

Phone +39 02 27 43 41
E-Mail info@sick.it

Japan

Phone +81 (0)3 5309 2112
E-Mail support@sick.jp

Magyarország

Phone +36 1 371 2680
E-Mail office@sick.hu

Nederland

Phone +31 (0)30 229 25 44
E-Mail info@sick.nl

Norge

Phone +47 67 81 50 00
E-Mail sick@sick.no

Österreich

Phone +43 (0)22 36 62 28 8-0
E-Mail office@sick.at

Polska

Phone +48 22 837 40 50
E-Mail info@sick.pl

România

Phone +40 356 171 120
E-Mail office@sick.ro

Russia

Phone +7-495-775-05-30
E-Mail info@sick.ru

Schweiz

Phone +41 41 619 29 39
E-Mail contact@sick.ch

Singapore

Phone +65 6744 3732
E-Mail sales.gsg@sick.com

Slovenija

Phone +386 (0)1-47 69 990
E-Mail office@sick.si

South Africa

Phone +27 11 472 3733
E-Mail info@sickautomation.co.za

South Korea

Phone +82 2 786 6321/4
E-Mail info@sickkorea.net

Suomi

Phone +358-9-25 15 800
E-Mail sick@sick.fi

Sverige

Phone +46 10 110 10 00
E-Mail info@sick.se

Taiwan

Phone +886 2 2375-6288
E-Mail sales@sick.com.tw

Türkiye

Phone +90 (216) 528 50 00
E-Mail info@sick.com.tr

United Arab Emirates

Phone +971 (0) 4 88 65 878
E-Mail info@sick.ae

USA/México

Phone +1(952) 941-6780
1 (800) 325-7425 – tollfree
E-Mail info@sickusa.com

More representatives and agencies
at www.sick.com