



Photoelectric sensors
Z1, Photoelectric proximity sensor, energetic

ZT1-P4231



Model Name > ZT1-P4231
Part No. > 1045599



Illustration may differ

At a glance

- Sensing distances of 50 mm, 60 mm, 100 mm or 155 mm, which are non-adjustable
- Infrared LED emitter
- Compact, transparent housing with 360° status indication
- M18 front mount and 24-25.4 mm slotted side through holes compatible with competitor devices

Your benefits

- Low-cost sensor for standard applications with small sensing distances
- Suitable for applications where the light spot needs to be invisible
- Clear housing provides 360° status indication, which simplifies troubleshooting
- Simple and unique mounting options lower installation costs
- Small size fits applications with limited space
- Compatibility with competitor products for easy integration into existing systems



Features

Sensor/detection principle:	Photoelectric proximity sensor, energetic
Dimensions (W x H x D):	13.6 mm x 34.8 mm x 23 mm
Housing design (light emission):	Hybrid
Thread diameter (housing):	M18 x 1
Sensing range max.:	1 mm ... 100 mm ¹⁾
Sensing range:	1 mm ... 100 mm
Type of light:	Infrared light
Light source:	LED ²⁾
Light spot (distance):	20 mm (100 mm)
Wave length:	880 nm

¹⁾ Object with 90 % reflectance (referred to standard white DIN 5033) ²⁾ Average service life 100,000 h at Ta = +25 °C

Mechanics/electronics

Supply voltage:	10 V DC ... 30 V DC ¹⁾
Ripple:	< 5 Vpp ²⁾
Power consumption:	< 20 mA ³⁾
Output type:	PNP, Light-switching
Output current I _{max.} :	50 mA
Switching frequency:	200 Hz ⁴⁾

Connection type:	Cable with plug, M8, 4-pin, 150 mm ⁵⁾
Circuit protection::	A, D ^{6) 7)}
Protection class:	III ⁸⁾
Housing material:	Glass fiber reinforced ABS plastic
Enclosure rating:	IP 67
Items supplied:	Mounting nut M18
Ambient operating temperature:	-25 °C ... 50 °C
Ambient storage temperature:	-40 °C ... 70 °C

1) Limit values 2) May not exceed or fall short of V_S 3) Without load 4) With light/dark ratio 1:1 5) Do not bend below 0 °C 6) A = V_S connections reverse-polarity protected 7) D = outputs overcurrent and short-circuit protected 8) Reference voltage 50 V DC

Dimensional drawing

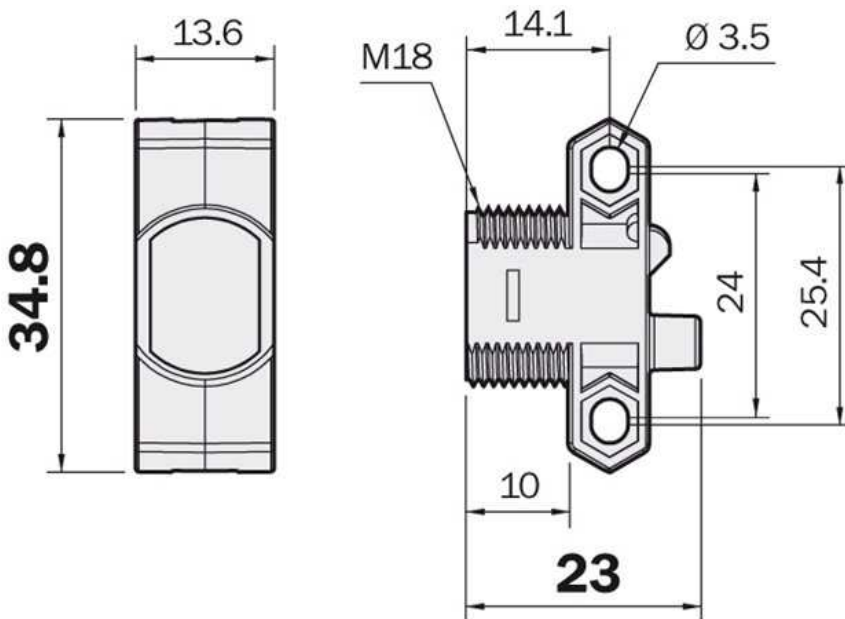

Connection diagram: receiver

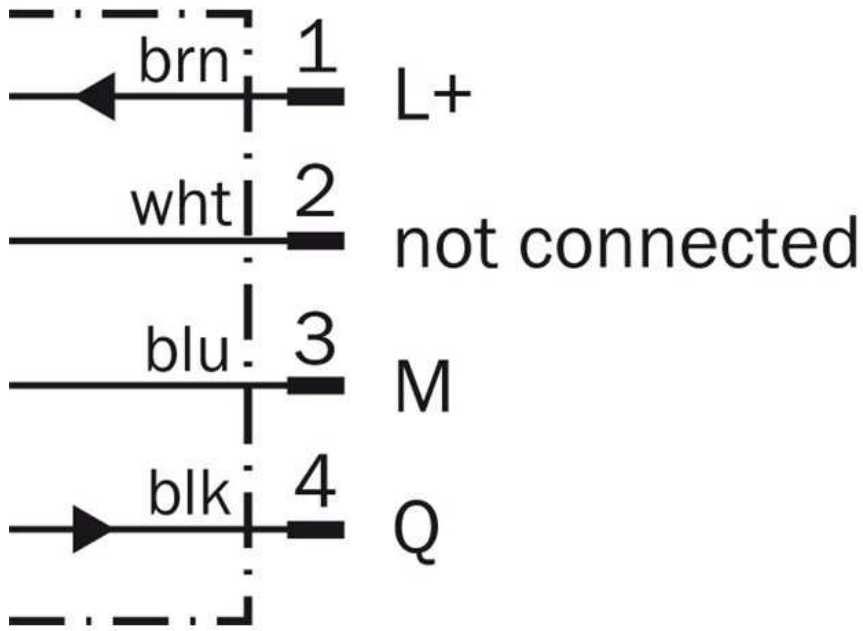

Connection type

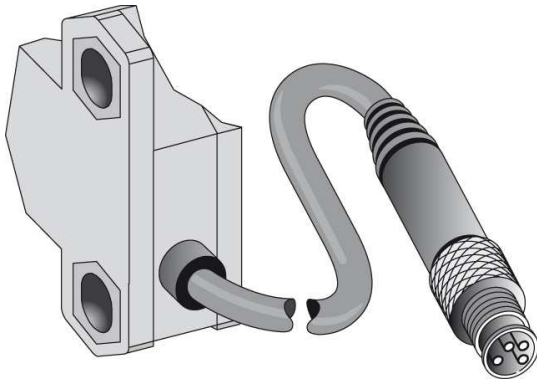

Sensing range diagram

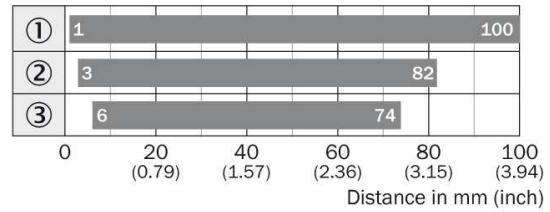

■ Sensing range ■ Sensing range typ. max.

- ① Sensing range on white, 90 % remission
- ② Sensing range on gray, 18 % remission
- ③ Sensing range on black, 6 % remission

Australia

Phone +61 3 9457 0600
1800 33 48 02 – tollfree
E-Mail sales@sick.com.au

Belgium/Luxembourg

Phone +32 (0)2 466 55 66
E-Mail info@sick.be

Brasil

Phone +55 11 3215-4900
E-Mail marketing@sick.com.br

Canada

Phone +1 905 771 14 44
E-Mail information@sick.com

Česká republika

Phone +420 2 57 91 18 50
E-Mail sick@sick.cz

China

Phone +86 4000 121 000
E-Mail info.china@sick.net.cn
Phone +852-2153 6300
E-Mail ghk@sick.com.hk

Danmark

Phone +45 45 82 64 00
E-Mail sick@sick.dk

Deutschland

Phone +49 211 5301-301
E-Mail info@sick.de

España

Phone +34 93 480 31 00
E-Mail info@sick.es

France

Phone +33 1 64 62 35 00
E-Mail info@sick.fr

Great Britain

Phone +44 (0)1727 831121
E-Mail info@sick.co.uk

India

Phone +91-22-4033 8333
E-Mail info@sick-india.com

Israel

Phone +972-4-6881000
E-Mail info@sick-sensors.com

Italia

Phone +39 02 27 43 41
E-Mail info@sick.it

Japan

Phone +81 (0)3 5309 2112
E-Mail support@sick.jp

Magyarország

Phone +36 1 371 2680
E-Mail office@sick.hu

Nederland

Phone +31 (0)30 229 25 44
E-Mail info@sick.nl

Norge

Phone +47 67 81 50 00
E-Mail sick@sick.no

Österreich

Phone +43 (0)22 36 62 28 8-0
E-Mail office@sick.at

Polska

Phone +48 22 837 40 50
E-Mail info@sick.pl

România

Phone +40 356 171 120
E-Mail office@sick.ro

Russia

Phone +7-495-775-05-30
E-Mail info@sick.ru

Schweiz

Phone +41 41 619 29 39
E-Mail contact@sick.ch

Singapore

Phone +65 6744 3732
E-Mail sales.gsg@sick.com

Slovenija

Phone +386 (0)1-47 69 990
E-Mail office@sick.si

South Africa

Phone +27 11 472 3733
E-Mail info@sickautomation.co.za

South Korea

Phone +82 2 786 6321/4
E-Mail info@sickkorea.net

Suomi

Phone +358-9-25 15 800
E-Mail sick@sick.fi

Sverige

Phone +46 10 110 10 00
E-Mail info@sick.se

Taiwan

Phone +886 2 2375-6288
E-Mail sales@sick.com.tw

Türkiye

Phone +90 (216) 528 50 00
E-Mail info@sick.com.tr

United Arab Emirates

Phone +971 (0) 4 88 65 878
E-Mail info@sick.ae

USA/México

Phone +1(952) 941-6780
1 (800) 325-7425 – tollfree
E-Mail info@sickusa.com

More representatives and agencies
at www.sick.com