



## Measuring automation light grids Profibus , MLG, MLG PROFIBUS

MLG5-2500P811



**Model Name** > [MLG5-2500P811](#)  
**Part No.** > [1047117](#)



**At a glance**

- Integrated PROFIBUS interface
- Resolutions of 10 / 20 / 30 / 50 mm and customer-specific resolutions
- Working range up to 8.5 m
- Detection heights of over 3 m and up to 240 beams possible
- Short response time
- External teach-in for optimal sensitivity settings

**Your benefits**

- Integrated PROFIBUS User Organization (PNO) number and GSD file for easy connection to a PLC
- Low cabling requirement reduces installation costs
- Easy-to-see light grid status information via the bus system helps avoid interrupting operation
- Different beam separation options, detection heights and output configurations ensure a reliable solution



**Features**

Technology:	Sender/receiver
Task:	Measurement light grid
Minimum detectable object (MDO) <sup>1)</sup> :	Parallel beam, 55 mm
Beam separation:	50 mm
Number of beams:	51
Detection height:	2,500 mm
Configuration:	GSD data file

<sup>1)</sup> MDO min. detectable object

**Performance**

Maximum range <sup>1)</sup> :	7 m
Minimum range:	Parallel beam: ≥0 mm
Response time <sup>2)</sup> :	Parallel beam 8.65 ms
Working range:	5 m

<sup>1)</sup> No reserve for environmental issue and deterioration of the diode <sup>2)</sup> With resistive load

## Interfaces

---

Data interface:	Profibus
Output type:	1 x PNP
Inputs:	1 x PNP
Connection type:	Male connector M12, 8-pin
IO-Link:	-

## Mechanics/electronics

---

Wave length:	Infrared light 880 nm
Supply voltage $V_s$ <sup>1)</sup> :	DC 18 V ... 30 V
Power consumption sender <sup>2)</sup> :	242 mA
Power consumption receiver <sup>3)</sup> :	253 mA
Ripple:	< 5 Vpp
Output current $I_{max}$ :	100 mA
Output load capacitive:	100 nF
Output load inductive:	1 H
Initialization time:	1 s
Dimensions (W x H x D):	34 mm x 2,614 mm x 29 mm
Housing material:	Aluminum
Indication:	7-segment display
Enclosure rating:	IP 65
Circuit protection:	Output Q short-circuit protected, Interference suppression, VS connections reverse-polarity protected
Weight:	6.25 kg
Front screen:	PMMA
Synchronization:	Cable

1) Without load    2) 3) Without load with 24 V

## Ambient data

---

Protection class:	III
EMC:	EN 60947-5-2
Ambient temperature:	Operation: -25 ... +55 °C, Storage: -40 ... +70 °C
Vibration resistance:	5 g, 10 Hz ... 55 Hz (IEC 68-2-6)
Shock load:	10 g/IEC 68-2-29/16 ms
Ambient light immunity::	Direct: $\geq 12,500$ lx, Indirect: $\geq 50,000$ lx <sup>1) 2)</sup>

1) 2) Sunlight

## Dimensional drawing

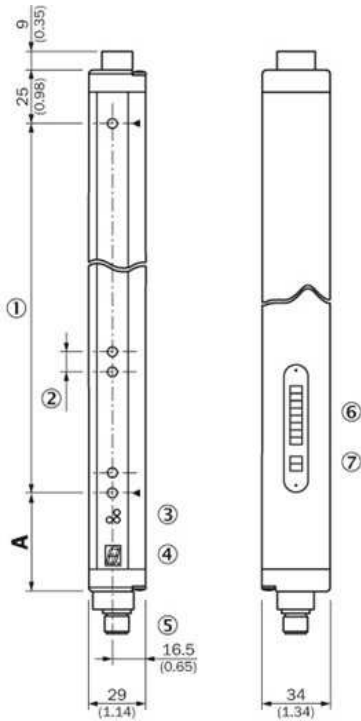

	<b>A</b>
	Distance: MLG edge - first beam
<b>Beam separation 10 mm</b>	49 (1.93)
<b>Beam separation 20 mm</b>	49 (1.93) <sup>1)</sup> / 59 (2.32) <sup>2)</sup>
<b>Beam separation 30 mm</b>	69 (2.72)
<b>Beam separation 50 mm</b>	89 (3.50)

<sup>1)</sup> With even number of beams.  
<sup>2)</sup> With odd number of beams.

- |1| Detection height (see optical performance)
- |2| Beam separation (10, 20, 30, 50 mm)
- |3| Status indicator: LEDs green, yellow, red
- |4| Indicator panel, 7-segment display
- |5| M12 plug, 8-pin/ M12 plug 5-pin
- |6| Address setting
- |7| Bus termination

## Adjustments DIP switches

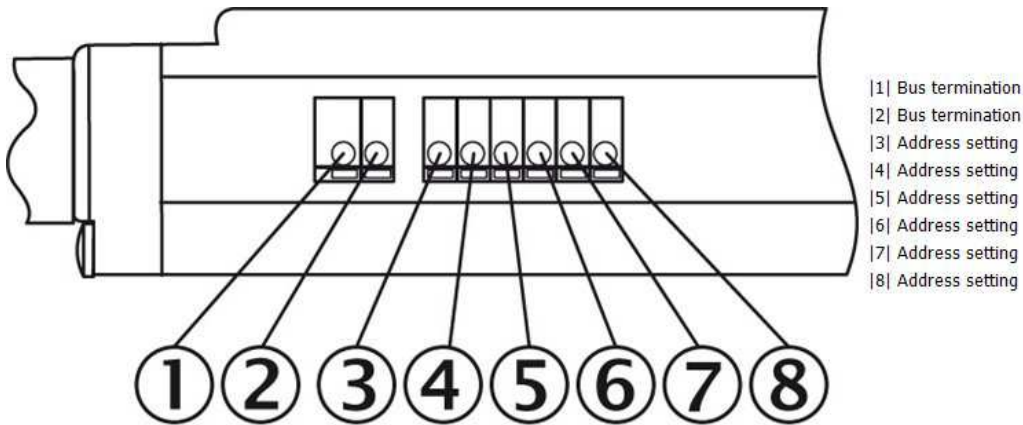

- |1| Bus termination
- |2| Bus termination
- |3| Address setting
- |4| Address setting
- |5| Address setting
- |6| Address setting
- |7| Address setting
- |8| Address setting

## Adjustments receiver

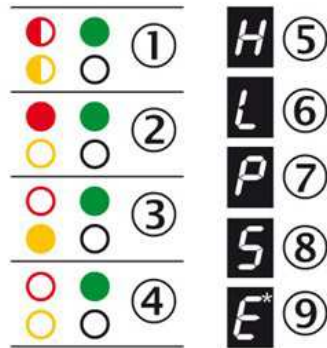
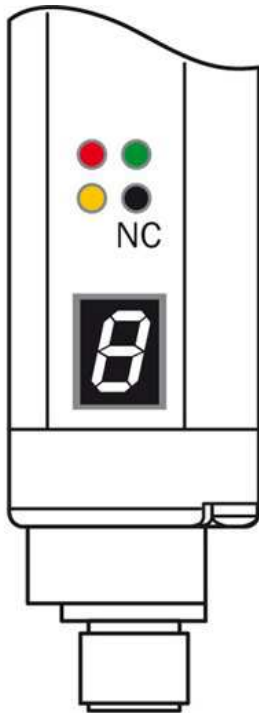

- ◐ blinks with 3 Hz
- on
- out
- ◐ on or out

- |1| Supply voltage
- |2| Device error
- |3| No object in the light path
- |4| Pollution indication
- |5| Blocked Beams Hold (BBH)
- |6| Activated teach-in procedure
- |7| ParamMode is active
- |8| standby
- |9| Error: E1 = sync. error; E2 = less receiver signal; E9 = defect

## Connection type and diagram

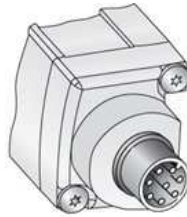
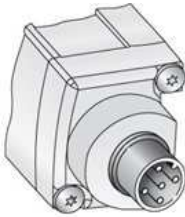

### Sender

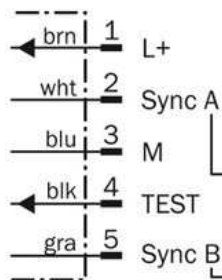

### Receiver

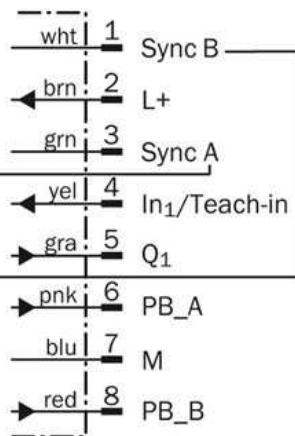

**Australia**

Phone +61 3 9457 0600  
1800 33 48 02 – tollfree  
E-Mail sales@sick.com.au

**Belgium/Luxembourg**

Phone +32 (0)2 466 55 66  
E-Mail info@sick.be

**Brasil**

Phone +55 11 3215-4900  
E-Mail marketing@sick.com.br

**Canada**

Phone +1 905 771 14 44  
E-Mail information@sick.com

**Česká republika**

Phone +420 2 57 91 18 50  
E-Mail sick@sick.cz

**China**

Phone +86 4000 121 000  
E-Mail info.china@sick.net.cn  
Phone +852-2153 6300  
E-Mail ghk@sick.com.hk

**Danmark**

Phone +45 45 82 64 00  
E-Mail sick@sick.dk

**Deutschland**

Phone +49 211 5301-301  
E-Mail info@sick.de

**España**

Phone +34 93 480 31 00  
E-Mail info@sick.es

**France**

Phone +33 1 64 62 35 00  
E-Mail info@sick.fr

**Great Britain**

Phone +44 (0)1727 831121  
E-Mail info@sick.co.uk

**India**

Phone +91-22-4033 8333  
E-Mail info@sick-india.com

**Israel**

Phone +972-4-6881000  
E-Mail info@sick-sensors.com

**Italia**

Phone +39 02 27 43 41  
E-Mail info@sick.it

**Japan**

Phone +81 (0)3 5309 2112  
E-Mail support@sick.jp

**Magyarország**

Phone +36 1 371 2680  
E-Mail office@sick.hu

**Nederland**

Phone +31 (0)30 229 25 44  
E-Mail info@sick.nl

**Norge**

Phone +47 67 81 50 00  
E-Mail sick@sick.no

**Österreich**

Phone +43 (0)22 36 62 28 8-0  
E-Mail office@sick.at

**Polska**

Phone +48 22 837 40 50  
E-Mail info@sick.pl

**România**

Phone +40 356 171 120  
E-Mail office@sick.ro

**Russia**

Phone +7-495-775-05-30  
E-Mail info@sick.ru

**Schweiz**

Phone +41 41 619 29 39  
E-Mail contact@sick.ch

**Singapore**

Phone +65 6744 3732  
E-Mail sales.gsg@sick.com

**Slovenija**

Phone +386 (0)1-47 69 990  
E-Mail office@sick.si

**South Africa**

Phone +27 11 472 3733  
E-Mail info@sickautomation.co.za

**South Korea**

Phone +82 2 786 6321/4  
E-Mail info@sickkorea.net

**Suomi**

Phone +358-9-25 15 800  
E-Mail sick@sick.fi

**Sverige**

Phone +46 10 110 10 00  
E-Mail info@sick.se

**Taiwan**

Phone +886 2 2375-6288  
E-Mail sales@sick.com.tw

**Türkiye**

Phone +90 (216) 528 50 00  
E-Mail info@sick.com.tr

**United Arab Emirates**

Phone +971 (0) 4 88 65 878  
E-Mail info@sick.ae

**USA/México**

Phone +1(952) 941-6780  
1 (800) 325-7425 – tollfree  
E-Mail info@sickusa.com

More representatives and agencies  
at [www.sick.com](http://www.sick.com)