



Photoelectric sensors
W18-2, Photoelectric proximity sensor,
Background suppression

WTV18-2P420S02



Model Name > [WTV18-2P420S02](#)
Part No. > [1047134](#)



Illustration may differ

At a glance

- High-performance background suppression with large sender/receiver distance and special V-optics
- Variants available for short and longer sensing distances
- Sensing distance adjustment via potentiometer
- Connection: M12, 4-pin

Your benefits

- High-performance background suppression with large transmitter/receiver distance and special V-optics ensure reliable object detection
- Reliable detection of highly reflective surfaces
- Less downtime in industrial environments
- Crosstalk and ambient light immunity reduce false readings

Features

Sensor/detection principle:	Photoelectric proximity sensor, Background suppression
Dimensions (W x H x D):	20 mm x 76 mm x 31.5 mm
Housing design (light emission):	Rectangular
Sensing range max.:	300 mm ... 1,400 mm ¹⁾
Sensing range:	300 mm ... 1,400 mm ²⁾
Type of light:	Infrared light
Light source:	LED ³⁾
Special features:	V-optics
Adjustment:	Potentiometer, 9 turns
Light spot size (distance):	Ø 8 mm (200 mm)
Continuous threshold adaption:	-

¹⁾ Object with 6 % remission ²⁾ Object with 90 % reflectance (referred to standard white, DIN 5033) ³⁾ Average service life of 100,000 h at T_A = +25 °C

Mechanics/electronics

Supply voltage:	10 V DC ... 30 V DC ¹⁾
Ripple:	< 5 Vpp ²⁾
Power consumption:	30 mA ³⁾
Output type:	PNP
Switching mode:	Light/dark switching
Output current I _{max.} :	100 mA
Response time:	< 2,000 µs ⁴⁾
Switching frequency:	250 Hz ⁵⁾
Connection type:	Connector M12, 4-pin

Circuit protection:::	A, C, D ^{6) 7) 8)}
Weight:	60 g
Special device:	✓
Housing material:	ABS, Plastic
Optics material:	PMMA
Enclosure rating:	IP 67
Ambient operating temperature:	-25 °C ... +75 °C
Ambient storage temperature:	-25 °C ... +60 °C

1) Limit values, operation in short-circuit protected network max. 8 A ²⁾ May not exceed or fall short of V_S tolerances ³⁾ Without load ⁴⁾ Signal transit time with resistive load ⁵⁾ With light/dark ratio 1:1 ⁶⁾ A = V_S connections reverse-polarity protected ⁷⁾ C = interference suppression ⁸⁾ D = outputs overcurrent and short-circuit protected

Dimensional drawing

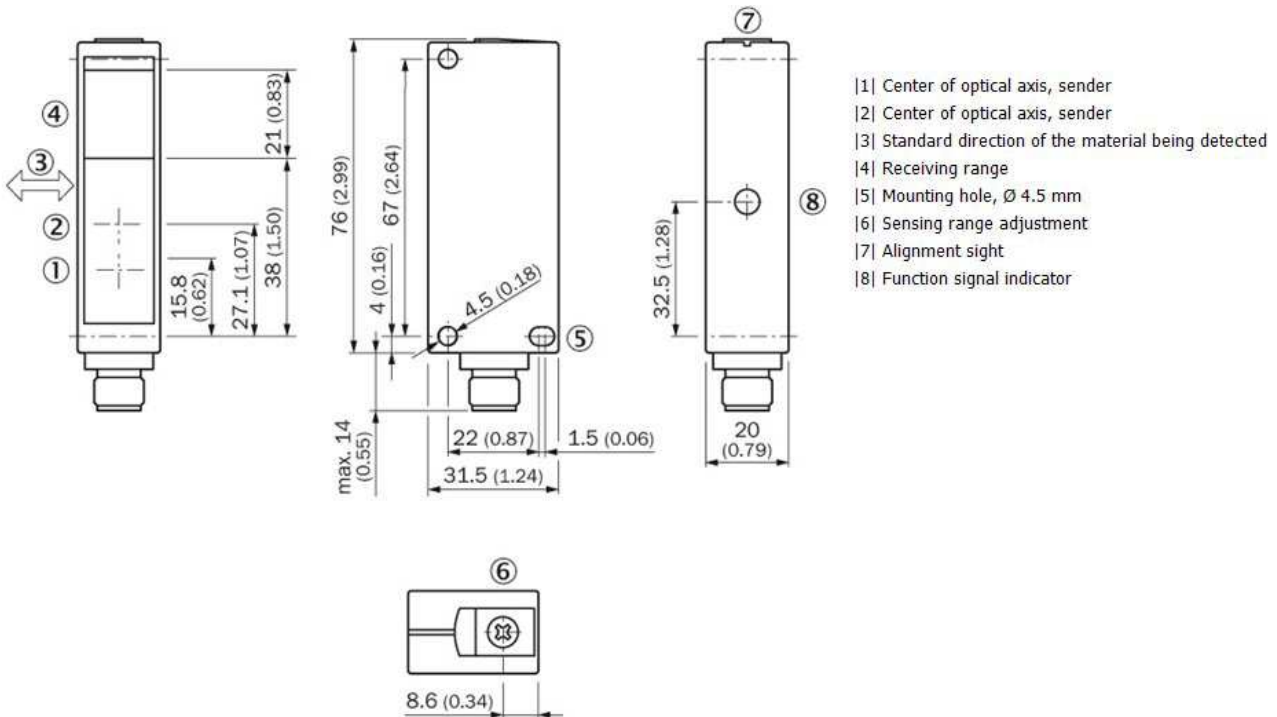

Adjustments possible

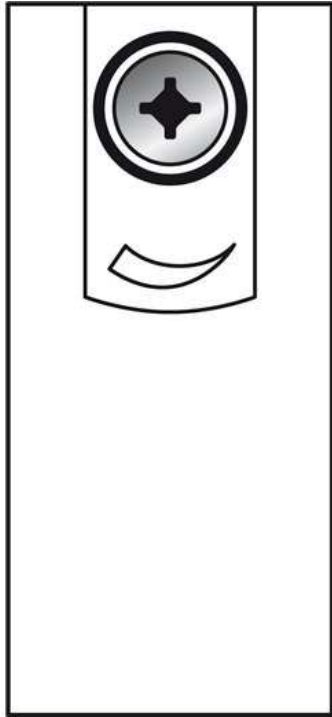

Connection diagram

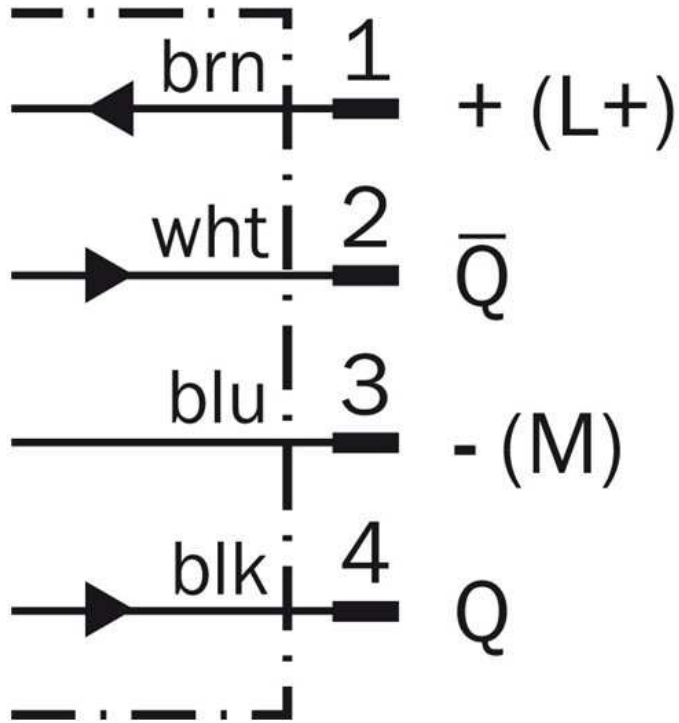

Connection type

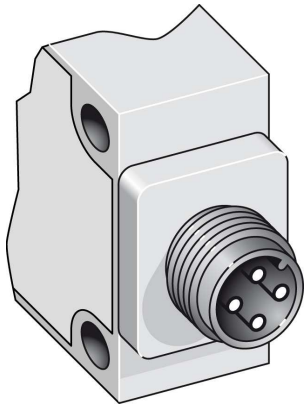

Australia

Phone +61 3 9457 0600
1800 33 48 02 – tollfree
E-Mail sales@sick.com.au

Belgium/Luxembourg

Phone +32 (0)2 466 55 66
E-Mail info@sick.be

Brasil

Phone +55 11 3215-4900
E-Mail marketing@sick.com.br

Canada

Phone +1 905 771 14 44
E-Mail information@sick.com

Česká republika

Phone +420 2 57 91 18 50
E-Mail sick@sick.cz

China

Phone +86 4000 121 000
E-Mail info.china@sick.net.cn
Phone +852-2153 6300
E-Mail ghk@sick.com.hk

Danmark

Phone +45 45 82 64 00
E-Mail sick@sick.dk

Deutschland

Phone +49 211 5301-301
E-Mail info@sick.de

España

Phone +34 93 480 31 00
E-Mail info@sick.es

France

Phone +33 1 64 62 35 00
E-Mail info@sick.fr

Great Britain

Phone +44 (0)1727 831121
E-Mail info@sick.co.uk

India

Phone +91-22-4033 8333
E-Mail info@sick-india.com

Israel

Phone +972-4-6881000
E-Mail info@sick-sensors.com

Italia

Phone +39 02 27 43 41
E-Mail info@sick.it

Japan

Phone +81 (0)3 5309 2112
E-Mail support@sick.jp

Magyarország

Phone +36 1 371 2680
E-Mail office@sick.hu

Nederland

Phone +31 (0)30 229 25 44
E-Mail info@sick.nl

Norge

Phone +47 67 81 50 00
E-Mail sick@sick.no

Österreich

Phone +43 (0)22 36 62 28 8-0
E-Mail office@sick.at

Polska

Phone +48 22 837 40 50
E-Mail info@sick.pl

România

Phone +40 356 171 120
E-Mail office@sick.ro

Russia

Phone +7-495-775-05-30
E-Mail info@sick.ru

Schweiz

Phone +41 41 619 29 39
E-Mail contact@sick.ch

Singapore

Phone +65 6744 3732
E-Mail sales.gsg@sick.com

Slovenija

Phone +386 (0)1-47 69 990
E-Mail office@sick.si

South Africa

Phone +27 11 472 3733
E-Mail info@sickautomation.co.za

South Korea

Phone +82 2 786 6321/4
E-Mail info@sickkorea.net

Suomi

Phone +358-9-25 15 800
E-Mail sick@sick.fi

Sverige

Phone +46 10 110 10 00
E-Mail info@sick.se

Taiwan

Phone +886 2 2375-6288
E-Mail sales@sick.com.tw

Türkiye

Phone +90 (216) 528 50 00
E-Mail info@sick.com.tr

United Arab Emirates

Phone +971 (0) 4 88 65 878
E-Mail info@sick.ae

USA/México

Phone +1(952) 941-6780
1 (800) 325-7425 – tollfree
E-Mail info@sickusa.com

More representatives and agencies
at www.sick.com