



Inductive proximity sensors  
Cylindrical threaded housing, IME30

IME30-10BPSZW6K



**Model Name** > [IME30-10BPSZW6K](#)  
**Part No.** > [1047654](#)



**At a glance**

- Size M30
- IP 67 enclosure rating
- Operating temperature from -25° C to +75° C

**Your benefits**

- Reduced machine downtime
- Reduced mechanical damage
- Fewer maintenance costs due to longer service life
- High resistance to shock and vibrations



**Features**

Design:	Cylindrical
Thread size:	M30 x 1.5
Sensing range Sn:	10 mm
Assured sensing range Sa:	8.1 mm
Installation type:	Flush
Switching frequency:	500 Hz
Output type:	PNP
Output function:	NO
Electrical wiring:	DC 3-wire
Enclosure rating:	IP 67 <sup>1)</sup>
Connection type:	Cable, 3-wire, 10 m
Housing:	Short-body

<sup>1)</sup> According to EN 60529

**Mechanics/electronics**

Supply voltage:	10 V DC ... 30 V DC
Ripple:	≤ 10 %
Voltage drop:	≤ 2 V
Power consumption:	≤ 10 mA <sup>1)</sup>
Time delay before availability:	≤ 125 ms
Hysteresis:	5 % ... 15 %
Repeatability:	≤ 2 % <sup>2) 3)</sup>
Temperature drift (of Sr):	± 10 %
EMC:	According to EN 60947-5-2

Output current I <sub>a</sub> :	≤ 200 mA
Cable material:	PVC
Short-circuit protection:	✓
Reverse polarity protection:	✓
Power-up pulse protection:	✓
Shock and vibration resistance:	30 g, 11 ms/10 Hz ... 55 Hz, 1 mm
Ambient operating temperature:	-25 °C ... 75 °C
Housing material:	Metal, Nickel-plated brass
Housing cap material:	Plastic, PA6
Housing length:	51 mm
Thread length:	35 mm
Tightening torque, max.:	100 Nm

1) Without load    2) U<sub>b</sub> and T<sub>a</sub> constant    3) Of Sr

### Reduction factors

---

Note:	The values are reference values which may vary
Carbon steel St37 (Fe):	1
Stainless steel (V2A, 304):	Ca. 0.8
Copper (Cu):	Ca. 0.4
Aluminum (Al):	Ca. 0.45
Brass (Br):	Ca. 0.4

### Installation note

---

B:	30 mm
C:	30 mm
D:	30 mm
F:	80 mm
Remark:	Associated graphic see "Installation"

## Installation note



## Dimensional drawing

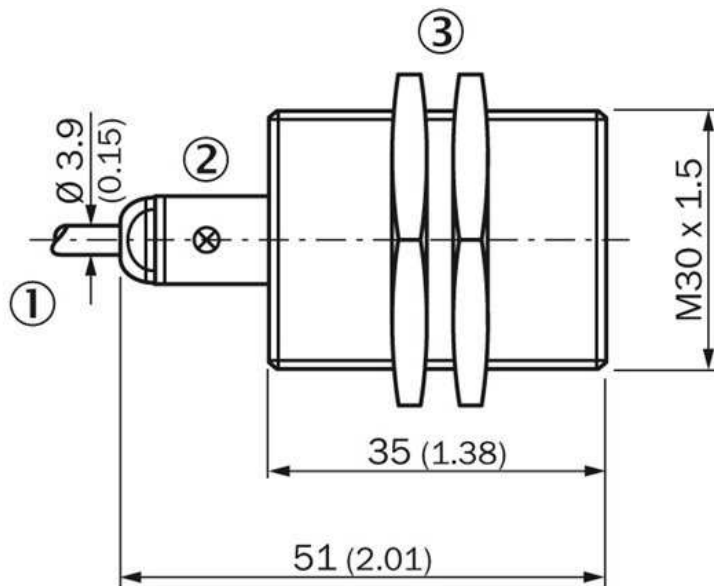

- |1| Connection
- |2| LED indicator
- |3| fastening nuts (2 x); 36 mm hex, metal

All dimensions in mm (inch)

Connection diagram

---



Connection type

---



**Australia**

Phone +61 3 9457 0600  
1800 33 48 02 – tollfree  
E-Mail sales@sick.com.au

**Belgium/Luxembourg**

Phone +32 (0)2 466 55 66  
E-Mail info@sick.be

**Brasil**

Phone +55 11 3215-4900  
E-Mail marketing@sick.com.br

**Canada**

Phone +1 905 771 14 44  
E-Mail information@sick.com

**Česká republika**

Phone +420 2 57 91 18 50  
E-Mail sick@sick.cz

**China**

Phone +86 4000 121 000  
E-Mail info.china@sick.net.cn  
Phone +852-2153 6300  
E-Mail ghk@sick.com.hk

**Danmark**

Phone +45 45 82 64 00  
E-Mail sick@sick.dk

**Deutschland**

Phone +49 211 5301-301  
E-Mail info@sick.de

**España**

Phone +34 93 480 31 00  
E-Mail info@sick.es

**France**

Phone +33 1 64 62 35 00  
E-Mail info@sick.fr

**Great Britain**

Phone +44 (0)1727 831121  
E-Mail info@sick.co.uk

**India**

Phone +91-22-4033 8333  
E-Mail info@sick-india.com

**Israel**

Phone +972-4-6881000  
E-Mail info@sick-sensors.com

**Italia**

Phone +39 02 27 43 41  
E-Mail info@sick.it

**Japan**

Phone +81 (0)3 5309 2112  
E-Mail support@sick.jp

**Magyarország**

Phone +36 1 371 2680  
E-Mail office@sick.hu

**Nederland**

Phone +31 (0)30 229 25 44  
E-Mail info@sick.nl

**Norge**

Phone +47 67 81 50 00  
E-Mail sick@sick.no

**Österreich**

Phone +43 (0)22 36 62 28 8-0  
E-Mail office@sick.at

**Polska**

Phone +48 22 837 40 50  
E-Mail info@sick.pl

**România**

Phone +40 356 171 120  
E-Mail office@sick.ro

**Russia**

Phone +7-495-775-05-30  
E-Mail info@sick.ru

**Schweiz**

Phone +41 41 619 29 39  
E-Mail contact@sick.ch

**Singapore**

Phone +65 6744 3732  
E-Mail sales.gsg@sick.com

**Slovenija**

Phone +386 (0)1-47 69 990  
E-Mail office@sick.si

**South Africa**

Phone +27 11 472 3733  
E-Mail info@sickautomation.co.za

**South Korea**

Phone +82 2 786 6321/4  
E-Mail info@sickkorea.net

**Suomi**

Phone +358-9-25 15 800  
E-Mail sick@sick.fi

**Sverige**

Phone +46 10 110 10 00  
E-Mail info@sick.se

**Taiwan**

Phone +886 2 2375-6288  
E-Mail sales@sick.com.tw

**Türkiye**

Phone +90 (216) 528 50 00  
E-Mail info@sick.com.tr

**United Arab Emirates**

Phone +971 (0) 4 88 65 878  
E-Mail info@sick.ae

**USA/México**

Phone +1(952) 941-6780  
1 (800) 325-7425 – tollfree  
E-Mail info@sickusa.com

More representatives and agencies  
at [www.sick.com](http://www.sick.com)