



## Magnetic Cylinder Sensors Analog positioning sensors

MPS-160TSTP0



**Model Name** > [MPS-160TSTP0](#)  
**Part No.** > [1050685](#)



#### At a glance

- Analog positioning sensor for pneumatic and hydraulic cylinders with T-slot
- Measuring lengths from 32 mm to 256 mm in 32 mm steps
- Output signals 4 mA to 20 mA as well as 0 V to 10 V in a single sensor
- Superior precision: 0.05 mm resolution typ., 0.1 mm repeatability typ., 0.3 mm linearity typ., 1 ms measurement rate typ.
- Electric setting of zero point and end point via teach-in button (optional)

#### Your benefits

- Convenient installation and sensor replacement due to drop-in installation
- Maximum flexibility through measuring ranges from 32 mm to 256 mm
- Increased machine performance thanks to the sensor's minimal blind zone
- Easy analog output setup: adjustable zero and end point can be taught via single button
- Selectable installation direction to optimize cabling
- Simple commissioning due to "in-range" indicator
- Flexible sensor settings, monitoring, advanced diagnostics, and visualization thanks to IO-Link save time and money



#### Features

Output function:	Analog
Electrical wiring:	DC 4-wire
Teach-in:	1
Cylinder type:	T-slot
Cylinder types with adapter:	Roundbody cylinder SMC rail cylinder CDQ2 SMC rail cylinder ECDQ2 Cylinders with dovetail slots
Measurement range:	160 mm <sup>1)</sup>
Housing length:	173 mm
Analog output (voltage):	0 V ... 10 V
Analog output (current):	4 mA ... 20 mA
Enclosure rating:	IP 67 <sup>2)</sup>

<sup>1)</sup> ± 1 mm <sup>2)</sup> According to EN 60529

#### Mechanics/electronics

Connection type:	Cable with connector M8, 4-pin, 0.3 m <sup>1)</sup>
Supply voltage:	15 V DC ... 30 V DC
EMC:	According to EN 60947-5-2 <sup>2)</sup>
Load resistance, max.:	500 Ω <sup>3)</sup>
Min. load resistance:	2 kΩ <sup>4)</sup>
Cable material:	PUR
Conductor cross-section:	0.14 mm <sup>2</sup>
Reverse polarity protection:	✓
Short-circuit protection:	✓
Housing material:	Plastic
Output indicator:	✓
Linearity typ.:	0.3 mm
Resolution typ.:	0.03 % FSR (max. ≥ 0.05 mm) <sup>5)</sup>
Repeat accuracy typ.:	0.06 % FSR (≥ 0.1 mm) <sup>6)</sup>
Shock and vibration resistance:	30 g, 11 ms/10 ... 55 Hz, 1 mm
Ambient operating temperature:	-20 °C ... 70 °C
Protection class:	III
Magnetic field sensitivity, typ.:	3 mT
Sampling rate typ.:	1 ms

1) Do not bend below 0 °C 2) The analog measured value can deviate under transient conditions 3) Power output 4) Voltage output 5) 6) FSR: Full Scale Range; max.

measuring range

### Dimensional drawing

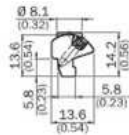
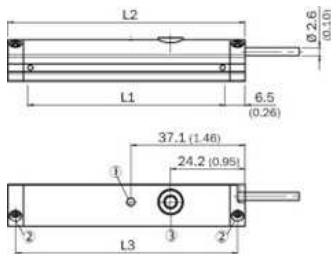

	Total length (L1) mm	Measuring range (L2) mm	Distance mounting screws (L3) mm
<b>MPS-32</b>	45	32	40
<b>MPS-64</b>	77	64	72
<b>MPS-96</b>	109	96	104
<b>MPS-128</b>	141	128	136
<b>MPS-160</b>	173	160	168
<b>MPS-192</b>	205	192	200
<b>MPS-224</b>	237	224	232
<b>MPS-256</b>	269	256	264

- |1| Function signal indicator
- |2| Fixing screw
- |3| Teach-in button

Connection diagram

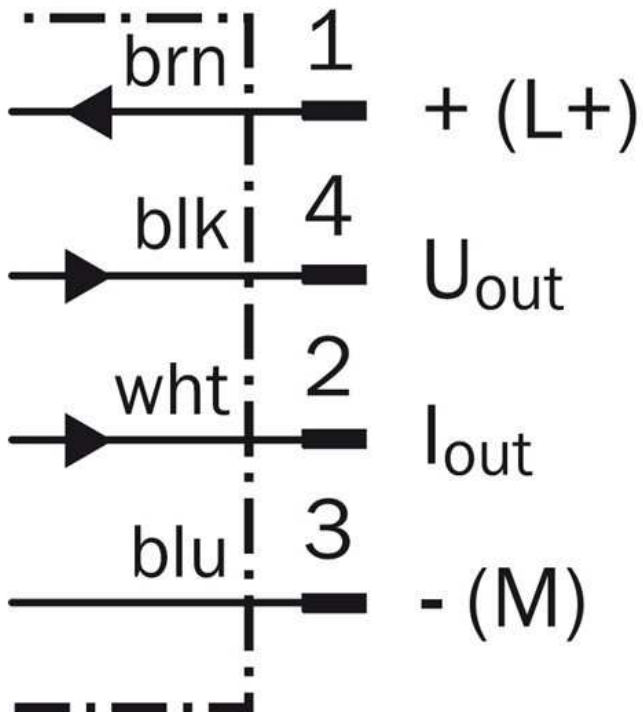

Connection type



**Australia**

Phone +61 3 9457 0600  
1800 33 48 02 – tollfree  
E-Mail sales@sick.com.au

**Belgium/Luxembourg**

Phone +32 (0)2 466 55 66  
E-Mail info@sick.be

**Brasil**

Phone +55 11 3215-4900  
E-Mail marketing@sick.com.br

**Canada**

Phone +1 905 771 14 44  
E-Mail information@sick.com

**Česká republika**

Phone +420 2 57 91 18 50  
E-Mail sick@sick.cz

**China**

Phone +86 4000 121 000  
E-Mail info.china@sick.net.cn  
Phone +852-2153 6300  
E-Mail ghk@sick.com.hk

**Danmark**

Phone +45 45 82 64 00  
E-Mail sick@sick.dk

**Deutschland**

Phone +49 211 5301-301  
E-Mail info@sick.de

**España**

Phone +34 93 480 31 00  
E-Mail info@sick.es

**France**

Phone +33 1 64 62 35 00  
E-Mail info@sick.fr

**Great Britain**

Phone +44 (0)1727 831121  
E-Mail info@sick.co.uk

**India**

Phone +91-22-4033 8333  
E-Mail info@sick-india.com

**Israel**

Phone +972-4-6881000  
E-Mail info@sick-sensors.com

**Italia**

Phone +39 02 27 43 41  
E-Mail info@sick.it

**Japan**

Phone +81 (0)3 5309 2112  
E-Mail support@sick.jp

**Magyarország**

Phone +36 1 371 2680  
E-Mail office@sick.hu

**Nederland**

Phone +31 (0)30 229 25 44  
E-Mail info@sick.nl

**Norge**

Phone +47 67 81 50 00  
E-Mail sick@sick.no

**Österreich**

Phone +43 (0)22 36 62 28 8-0  
E-Mail office@sick.at

**Polska**

Phone +48 22 837 40 50  
E-Mail info@sick.pl

**România**

Phone +40 356 171 120  
E-Mail office@sick.ro

**Russia**

Phone +7-495-775-05-30  
E-Mail info@sick.ru

**Schweiz**

Phone +41 41 619 29 39  
E-Mail contact@sick.ch

**Singapore**

Phone +65 6744 3732  
E-Mail sales.gsg@sick.com

**Slovenija**

Phone +386 (0)1-47 69 990  
E-Mail office@sick.si

**South Africa**

Phone +27 11 472 3733  
E-Mail info@sickautomation.co.za

**South Korea**

Phone +82 2 786 6321/4  
E-Mail info@sickkorea.net

**Suomi**

Phone +358-9-25 15 800  
E-Mail sick@sick.fi

**Sverige**

Phone +46 10 110 10 00  
E-Mail info@sick.se

**Taiwan**

Phone +886 2 2375-6288  
E-Mail sales@sick.com.tw

**Türkiye**

Phone +90 (216) 528 50 00  
E-Mail info@sick.com.tr

**United Arab Emirates**

Phone +971 (0) 4 88 65 878  
E-Mail info@sick.ae

**USA/México**

Phone +1(952) 941-6780  
1 (800) 325-7425 – tollfree  
E-Mail info@sickusa.com

More representatives and agencies  
at [www.sick.com](http://www.sick.com)