



Photoelectric sensors  
G6, Photoelectric retro-reflective sensor,  
Standard optics

GL6-N1112



**Model Name** > [GL6-N1112](#)  
**Part No.** > [1051780](#)



*Illustration may differ*

**At a glance**

- PinPoint LED for a bright, precise light spot
- Durable metal threaded inserts
- SICK ASIC technology - the result of decades of experience in photoelectric sensors
- Large, user-friendly potentiometer
- Large, bright indicator LEDs
- IP 67 enclosure rating

**Your benefits**

- Easy alignment and precise object detection due to a highly visible PinPoint LED
- Quick and easy mounting and high durability due to threaded metal inserts
- SICK ASIC technology provides high performance, excellent reliability and crosstalk immunity
- Easy to adjust due to large, user-friendly potentiometers
- Easy to monitor due to large, bright indicator LEDs
- Easy installation with SICK accessories



**Features**

Sensor/detection principle:	Photoelectric retro-reflective sensor, Standard optics
Dimensions (W x H x D):	12 mm x 31.5 mm x 21 mm
Housing design (light emission):	Rectangular
Sensing range max.:	≤ 6 m <sup>1)</sup>
Sensing range:	≤ 5 m <sup>2)</sup>
Type of light:	Visible red light
Light source:	PinPoint LED <sup>3)</sup>
Wave length:	650 nm
Light spot size (distance):	Ø 8 mm (350 mm)

<sup>1) 2)</sup> PL80A <sup>3)</sup> Average service life of 100,000 h at T<sub>A</sub> = +25 °C

**Mechanics/electronics**

Supply voltage:	10 V DC ... 30 V DC <sup>1)</sup>
Ripple:	± 10 % <sup>2)</sup>
Power consumption:	≤ 30 mA <sup>3)</sup>
Output type:	NPN, open collector
Switching mode:	Light/dark switching

Switching mode selector:	Selectable via light/dark selector
Output current I <sub>max</sub> ..:	≤ 100 mA <sup>4)</sup>
Response time:	< 625 μs <sup>5)</sup>
Switching frequency:	1,000 Hz <sup>6)</sup>
Connection type:	Cable, 3-wire, 2 m <sup>7)</sup>
Cable material:	PVC
Conductor cross-section:	0.14 mm <sup>2</sup>
Circuit protection:::	A, B, D <sup>8) 9) 10)</sup>
Protection class:	III
Weight:	60 g
Polarisation filter:	✓
Optics material:	PMMA
Enclosure rating:	IP 67
Items supplied:	Stainless steel mounting bracket (1.4301/304) BEF-W100-A, Reflector P250
Ambient operating temperature:	-25 °C ... +55 °C <sup>11)</sup>
Ambient storage temperature:	-40 °C ... +70 °C
UL File No.:	NRKH.E348498 & NRKH7.E348498
Signal voltage NPN HIGH/LOW:	Approx. V <sub>S</sub> /≤ 3 V
Housing material:	ABS/PC, Plastic

1) Limit values, operation in short-circuit protected network max. 8 A    2) May not exceed or fall short of V<sub>S</sub> tolerances    3) Without load    4) At V<sub>S</sub> > 24 V, I<sub>A</sub> max = 50 mA  
5) Signal transit time with resistive load    6) With light/dark ratio 1:1    7) Do not bend below 0 °C    8) A = V<sub>S</sub> connections reverse-polarity protected    9) B = inputs and output reverse-polarity protected    10) D = outputs overcurrent and short-circuit protected    11) Temperature stability after adjustment +/-10°C

### Dimensional drawing

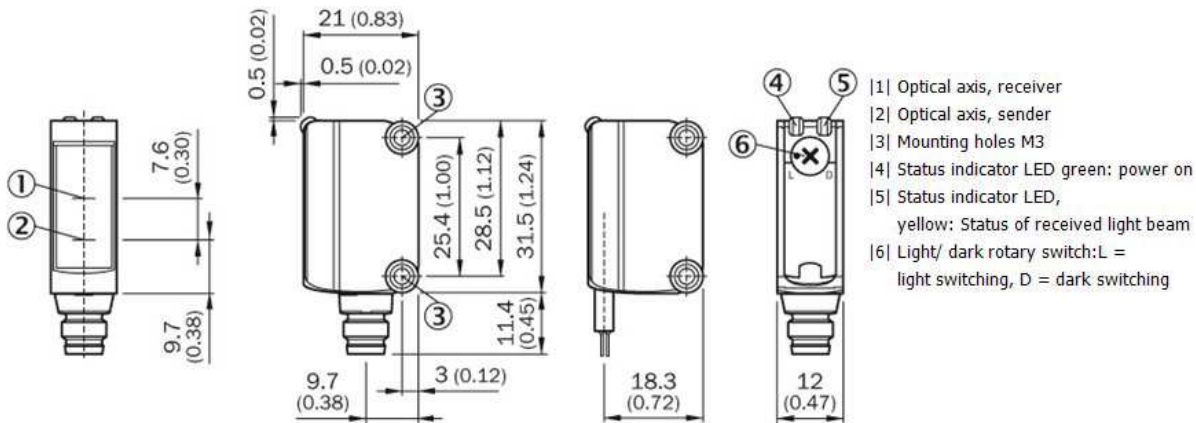

## Adjustments possible

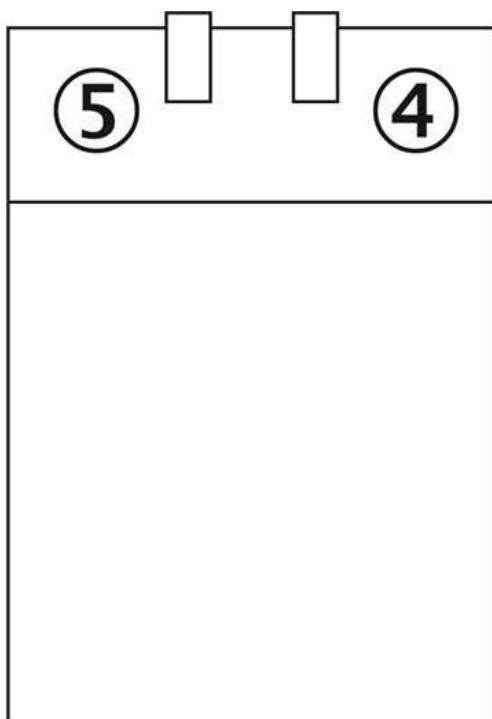

- |4| Status indicator LED green: power on
- |5| Status indicator LED,  
yellow: Status of received light beam

## Connection diagram

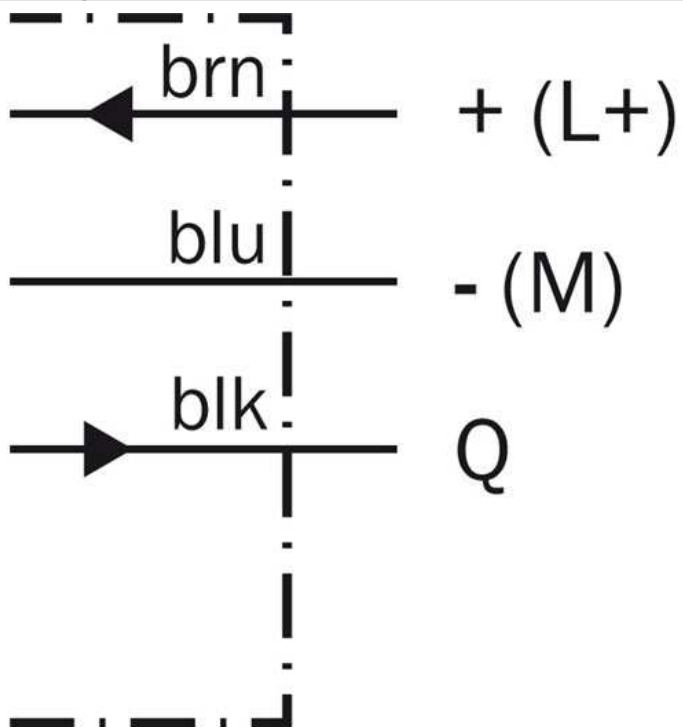

## Characteristic curve

Operating reserve

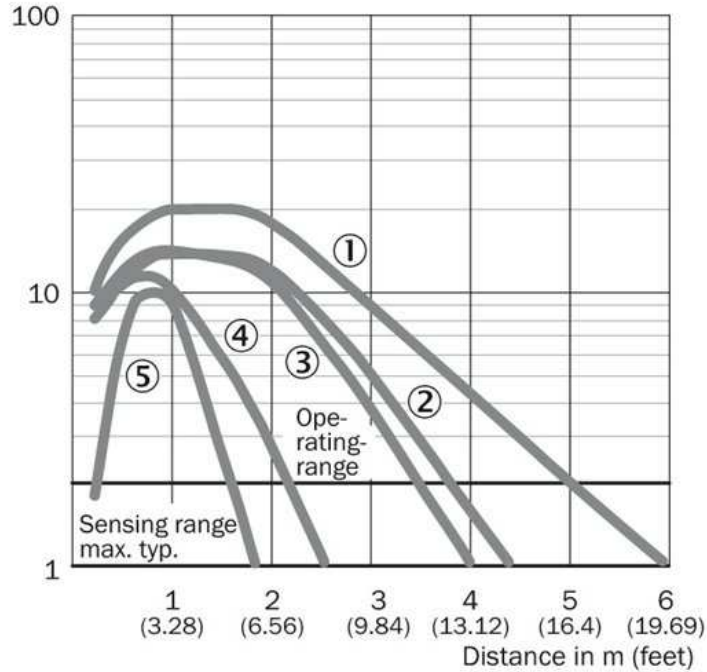

- |1| PL80A
- |2| PL40A
- |3| P250
- |4| PL20A
- |5| REF-IRF-56

## Sensing range diagram

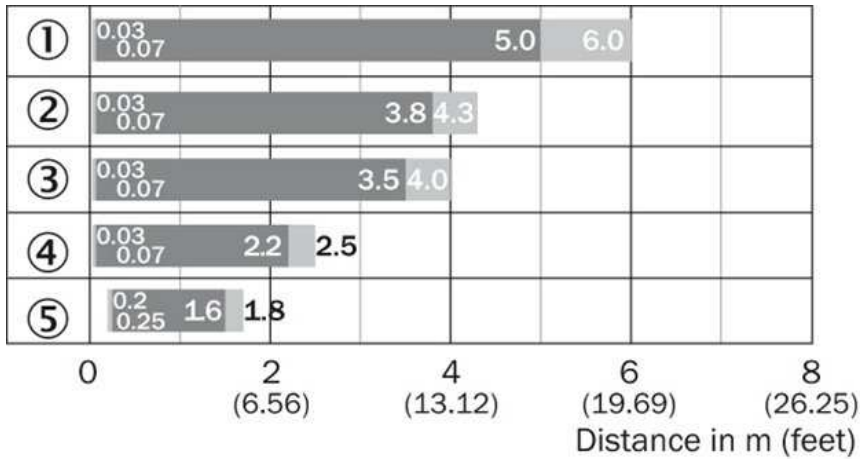

- |1| PL80A
- |2| PL40A
- |3| P250
- |4| PL20A
- |5| REF-IRF-56

■ Sensing range      ■ Sensing range max.

## Connection type

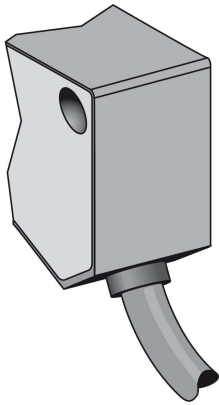

## Light spot size

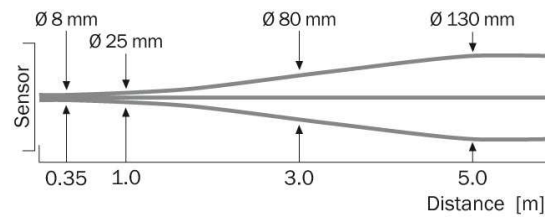

**Australia**

Phone +61 3 9457 0600  
1800 33 48 02 – tollfree  
E-Mail sales@sick.com.au

**Belgium/Luxembourg**

Phone +32 (0)2 466 55 66  
E-Mail info@sick.be

**Brasil**

Phone +55 11 3215-4900  
E-Mail marketing@sick.com.br

**Canada**

Phone +1 905 771 14 44  
E-Mail information@sick.com

**Česká republika**

Phone +420 2 57 91 18 50  
E-Mail sick@sick.cz

**China**

Phone +86 4000 121 000  
E-Mail info.china@sick.net.cn  
Phone +852-2153 6300  
E-Mail ghk@sick.com.hk

**Danmark**

Phone +45 45 82 64 00  
E-Mail sick@sick.dk

**Deutschland**

Phone +49 211 5301-301  
E-Mail info@sick.de

**España**

Phone +34 93 480 31 00  
E-Mail info@sick.es

**France**

Phone +33 1 64 62 35 00  
E-Mail info@sick.fr

**Great Britain**

Phone +44 (0)1727 831121  
E-Mail info@sick.co.uk

**India**

Phone +91-22-4033 8333  
E-Mail info@sick-india.com

**Israel**

Phone +972-4-6881000  
E-Mail info@sick-sensors.com

**Italia**

Phone +39 02 27 43 41  
E-Mail info@sick.it

**Japan**

Phone +81 (0)3 5309 2112  
E-Mail support@sick.jp

**Magyarország**

Phone +36 1 371 2680  
E-Mail office@sick.hu

**Nederland**

Phone +31 (0)30 229 25 44  
E-Mail info@sick.nl

**Norge**

Phone +47 67 81 50 00  
E-Mail sick@sick.no

**Österreich**

Phone +43 (0)22 36 62 28 8-0  
E-Mail office@sick.at

**Polska**

Phone +48 22 837 40 50  
E-Mail info@sick.pl

**România**

Phone +40 356 171 120  
E-Mail office@sick.ro

**Russia**

Phone +7-495-775-05-30  
E-Mail info@sick.ru

**Schweiz**

Phone +41 41 619 29 39  
E-Mail contact@sick.ch

**Singapore**

Phone +65 6744 3732  
E-Mail sales.gsg@sick.com

**Slovenija**

Phone +386 (0)1-47 69 990  
E-Mail office@sick.si

**South Africa**

Phone +27 11 472 3733  
E-Mail info@sickautomation.co.za

**South Korea**

Phone +82 2 786 6321/4  
E-Mail info@sickkorea.net

**Suomi**

Phone +358-9-25 15 800  
E-Mail sick@sick.fi

**Sverige**

Phone +46 10 110 10 00  
E-Mail info@sick.se

**Taiwan**

Phone +886 2 2375-6288  
E-Mail sales@sick.com.tw

**Türkiye**

Phone +90 (216) 528 50 00  
E-Mail info@sick.com.tr

**United Arab Emirates**

Phone +971 (0) 4 88 65 878  
E-Mail info@sick.ae

**USA/México**

Phone +1(952) 941-6780  
1 (800) 325-7425 – tollfree  
E-Mail info@sickusa.com

More representatives and agencies  
at [www.sick.com](http://www.sick.com)