



Level sensors
TDR level sensor

LFP0400-G1NMB

Model Name > [LFP0400-G1NMB](#)
Part No. > [1052069](#)



At a glance

- Level monitoring in hygienic applications
- Manually cutable monoprobe up to 4,000 mm long with Ra 0.8 µm
- Process temperature up to 180 °C, process pressure up to 16 bar
- CIP/SIP resistant
- High enclosure rating IP 67 and IP 69K, autoclavable
- Interchangeable hygienic process connections
- 3 in 1: combined display, analog output and binary output
- Remote amplifier version with compact process connection

Your benefits

- Robust design increases service life
- High flexibility due to cutable probe and interchangeable connection concept
- Cost savings due to multiple output signals: one system for both level detection and continuous level monitoring
- Time and cost savings due to low maintenance without any calibration and quick commissioning Remote display of the measured value and space savings



Features

Medium:	Fluids
Measurement:	Switch, Continuous
Probe length:	400 mm
Process pressure:	-1 bar ... 16 bar
Process temperature:	-20 °C ... +150 °C
EHEDG approval:	✓
GOST approval:	✓
UL approval:	✓
RoHS certificate:	✓
IO-Link:	✓
3-A:	-
Design:	Standard

Performance

Resolution:	< 2 mm
Accuracy of sensor element:	± 5 mm
Repeatability:	≤ 2 mm
Dielectricity constant:	≥ 1.8 with coaxial tube, ≥ 5 for mono probe

Inactive area at process connector:	25 mm ¹⁾
Inactive area at probe end:	10 mm ²⁾
Conductivity:	No limitation
Response time:	< 400 ms ³⁾
MTTF:	194.3 a (EN ISO 13849-1)

¹⁾ With parameterized tank with water under reference conditions, otherwise 40 mm ²⁾ With water under reference conditions ³⁾ Depending on measuring mode (high speed < 400 ms, high accuracy < 2,800 ms).

Mechanical data

Housing material:	303
Max.probe load:	6 Nm
Process connection:	G 3/4 A
Wetted parts:	316L (Ra ≤ 0,8 μm), PEEK
Housing design:	With PMMA viewing window

Electrical data

Temperature drift:	< 0.1 mm/K
Enclosure rating:	IP 67: EN 60529, IP 69K: EN 40050
Supply voltage:	12 V DC ... 30 V DC ¹⁾
Power consumption:	≤ 75 mA at 24 V DC without output load
Protection class:	III
Initialization time:	≤ 2 s
Output load:	0 V ... 10 V > 750 Ohm at Uv ≥ 14 V, 4 mA ... 20 mA < 400 Ohm at Uv > 12 V, 4 mA ... 20 mA < 500 Ohm at Uv > 13,5 V
Upper signal level:	20 mA ... 20.5 mA
Lower signal level:	3.8 mA ... 4 mA
Hysteresis:	Min. 2 mm, free adjustable
Output current:	< 100 mA
Signal voltage HIGH:	Vs - 2 V
Signal voltage LOW:	≤ 2 V
Capacitive load:	100 nF
Inductive load:	< 1 H
Connection type:	Round connector M12 x 1, 5-pin
EMC:	EN 61326-1:2006, 2004/108/EG
Interference resistance:	EN 61000-6-2:2005
Interference emission:	EN 61000-6-4:2007
Single- and continuous shock:	EN 60068-2-27

¹⁾ All connections are polarity protected. All outputs are overload and short-circuit protected.

Ambient data

Ambient operating temperature:	-20 °C ... +60 °C
Ambient storage temperature:	-40 °C ... +80 °C

Dimensional drawing

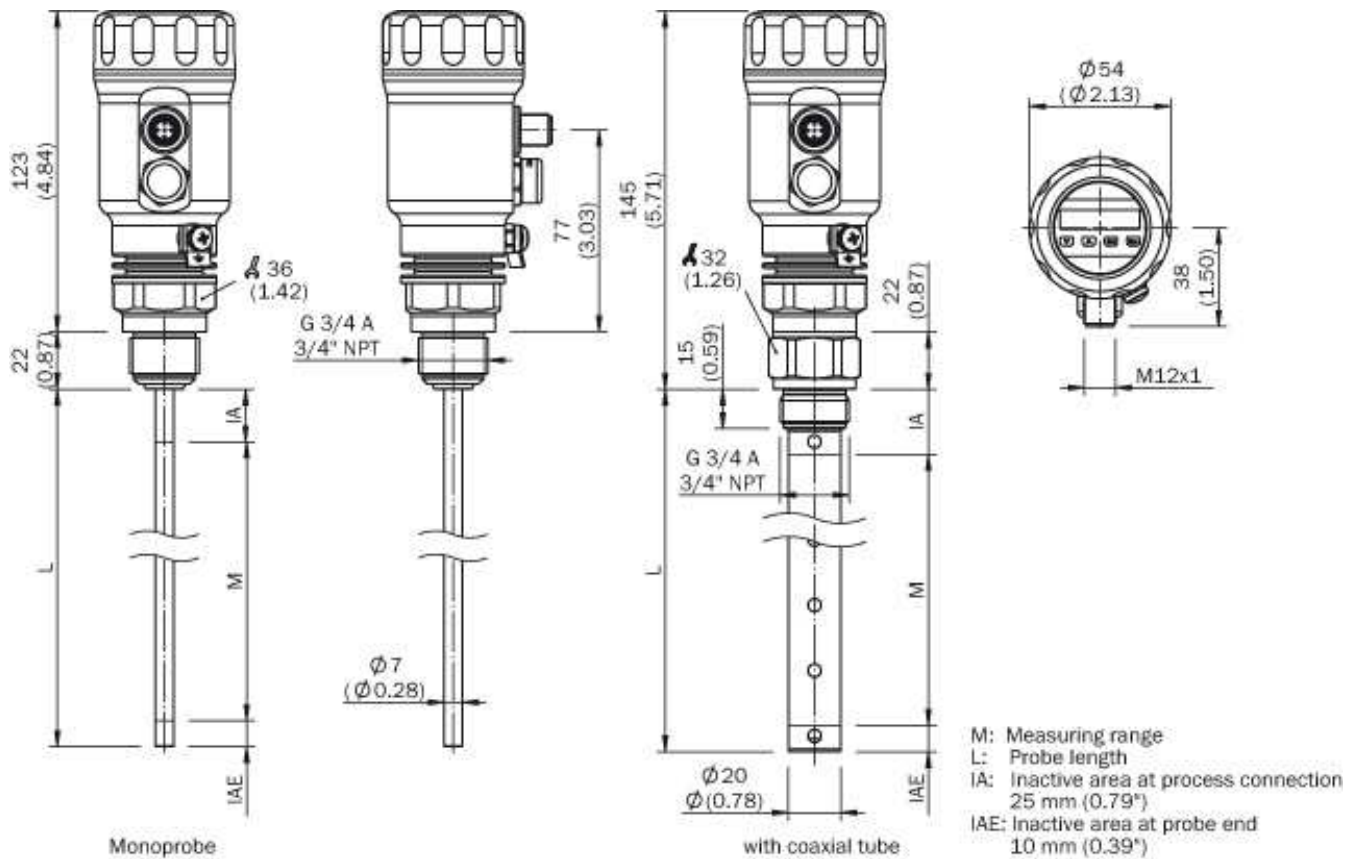

Connection type

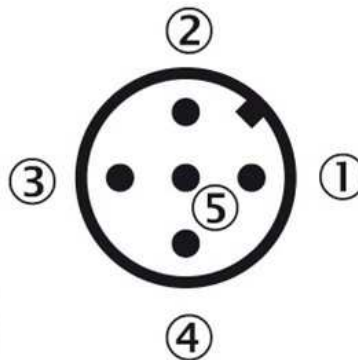
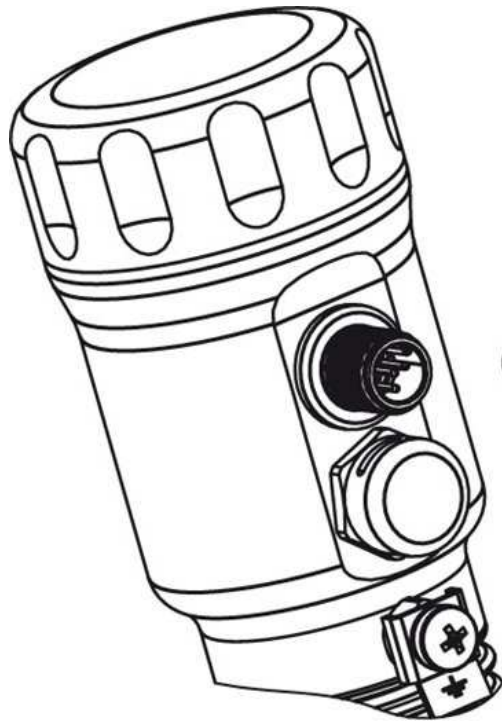

- [1] L+: Supply voltage, brown
- [2] QA: Analog current-/voltage output, white
- [3] M: Ground, reference ground
for current-/voltage output, blue
- [4] C/Q1: Switching output 1,
PNP/IO-Link-communication, black
- [5] Q2: Switching output 2, PNP/NPN, grey

Australia

Phone +61 3 9457 0600
1800 33 48 02 – tollfree
E-Mail sales@sick.com.au

Belgium/Luxembourg

Phone +32 (0)2 466 55 66
E-Mail info@sick.be

Brasil

Phone +55 11 3215-4900
E-Mail marketing@sick.com.br

Canada

Phone +1 905 771 14 44
E-Mail information@sick.com

Česká republika

Phone +420 2 57 91 18 50
E-Mail sick@sick.cz

China

Phone +86 4000 121 000
E-Mail info.china@sick.net.cn
Phone +852-2153 6300
E-Mail ghk@sick.com.hk

Danmark

Phone +45 45 82 64 00
E-Mail sick@sick.dk

Deutschland

Phone +49 211 5301-301
E-Mail info@sick.de

España

Phone +34 93 480 31 00
E-Mail info@sick.es

France

Phone +33 1 64 62 35 00
E-Mail info@sick.fr

Great Britain

Phone +44 (0)1727 831121
E-Mail info@sick.co.uk

India

Phone +91-22-4033 8333
E-Mail info@sick-india.com

Israel

Phone +972-4-6881000
E-Mail info@sick-sensors.com

Italia

Phone +39 02 27 43 41
E-Mail info@sick.it

Japan

Phone +81 (0)3 5309 2112
E-Mail support@sick.jp

Magyarország

Phone +36 1 371 2680
E-Mail office@sick.hu

Nederland

Phone +31 (0)30 229 25 44
E-Mail info@sick.nl

Norge

Phone +47 67 81 50 00
E-Mail sick@sick.no

Österreich

Phone +43 (0)22 36 62 28 8-0
E-Mail office@sick.at

Polska

Phone +48 22 837 40 50
E-Mail info@sick.pl

România

Phone +40 356 171 120
E-Mail office@sick.ro

Russia

Phone +7-495-775-05-30
E-Mail info@sick.ru

Schweiz

Phone +41 41 619 29 39
E-Mail contact@sick.ch

Singapore

Phone +65 6744 3732
E-Mail sales.gsg@sick.com

Slovenija

Phone +386 (0)1-47 69 990
E-Mail office@sick.si

South Africa

Phone +27 11 472 3733
E-Mail info@sickautomation.co.za

South Korea

Phone +82 2 786 6321/4
E-Mail info@sickkorea.net

Suomi

Phone +358-9-25 15 800
E-Mail sick@sick.fi

Sverige

Phone +46 10 110 10 00
E-Mail info@sick.se

Taiwan

Phone +886 2 2375-6288
E-Mail sales@sick.com.tw

Türkiye

Phone +90 (216) 528 50 00
E-Mail info@sick.com.tr

United Arab Emirates

Phone +971 (0) 4 88 65 878
E-Mail info@sick.ae

USA/México

Phone +1(952) 941-6780
1 (800) 325-7425 – tollfree
E-Mail info@sickusa.com

More representatives and agencies
at www.sick.com