



Photoelectric sensors
W4S-3 Inox, Through-beam photoelectric sensor

WSE4S-3P1330V



Model Name > [WSE4S-3P1330V](#)
Part No. > [1052887](#)



Illustration may differ

At a glance

- WashDown rated for fluid tightness (IP 66, IP 67, IP 68 and IP 69K) and Ecolab certified
- Tough stainless steel housing (316L/1.4404)
- Resistant to a variety of common cleaning and disinfection agents
- Modern electrical connection available - M12 connector with pin casting
- Teach-in via stainless steel metal membrane teach button
- PinPoint LED technology provides a highly visible laser-like light spot

Your benefits

- Long service life in harsh conditions ensures less downtime and fewer replacement costs
- Quick and easy alignment due to highly visible PinPoint emitter LED
- Easy adjustment via a stainless steel metal membrane teach-in pushbutton



Features

Sensor/detection principle:	Through-beam photoelectric sensor
Dimensions (W x H x D):	15.25 mm x 48.6 mm x 22.2 mm
Housing design:	Washdown
Housing design (light emission):	Rectangular
Sensing range max.:	0 m ... 5 m
Sensing range:	0 m ... 4.5 m
Type of light:	Visible red light
Light source:	PinPoint LED ¹⁾
Wave length:	650 nm
Light spot size (distance):	Ø 50 mm (2 m)

¹⁾ Average service life: 100,000 h at T_U = +25 °C

Mechanics/electronics

Supply voltage:	10 V DC ... 30 V DC ¹⁾
Ripple:	< 5 Vpp ²⁾
Power consumption, sender:	≤ 20 mA ³⁾
Power consumption, receiver:	≤ 20 mA ⁴⁾
Power consumption:	≤ 30 mA ⁵⁾
Output type:	PNP
Switching mode:	Light switching

Output current I _{max} :	≤ 100 mA
Response time:	≤ < 0.5 ms ⁶⁾
Switching frequency:	1,000 Hz ⁷⁾
Connection type:	Cable, 3-wire, 2 m ⁸⁾
Cable material:	PVC
Conductor cross-section:	0.14 mm ²
Circuit protection:::	A B ⁹⁾ ¹⁰⁾ ¹¹⁾ C
Protection class:	III
Weight:	80 g
Special device:	-
Enclosure rating:	IP 66 IP 67 IP 68 IP 69K
Test input sender off:	TE to 0 V
Ambient operating temperature:	-30 °C ... +70 °C ¹²⁾
Ambient storage temperature:	-30 °C ... +75 °C
Part number of individual components:	Receiver, WE4S-3P1330V, 2058739, Sender, WS4S-3D1330V, 2058460
UL File No.:	NRKH.E181493 & NRKH7.E181493
Housing material:	Stainless steel, Stainless steel 316L

¹⁾ Limit values, reverse-polarity protected, operation in short-circuit protected network: max. 8 A ²⁾ May not exceed or fall below U_v tolerances ³⁾ ⁴⁾ ⁵⁾ Without load ⁶⁾
 Signal transit time with resistive load ⁷⁾ With light/dark ratio 1:1 ⁸⁾ Do not bend below 0 °C ⁹⁾ A = V_S connections reverse-polarity protected ¹⁰⁾ B = inputs and output
 reverse-polarity protected ¹¹⁾ C = interference suppression ¹²⁾ At UV ≤ 24 V and IA < 30 mA

Dimensional drawing

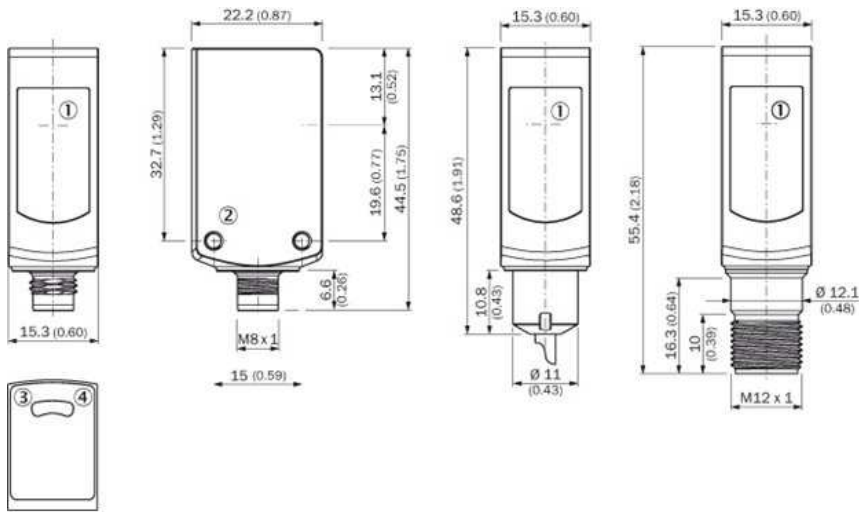

- |1| Center of optical axis
- |2| Threaded mounting hole M3
- |3| Status indicator LED, yellow: Status of received light beam
- |4| Status indicator LED green: supply voltage on

Connection diagram

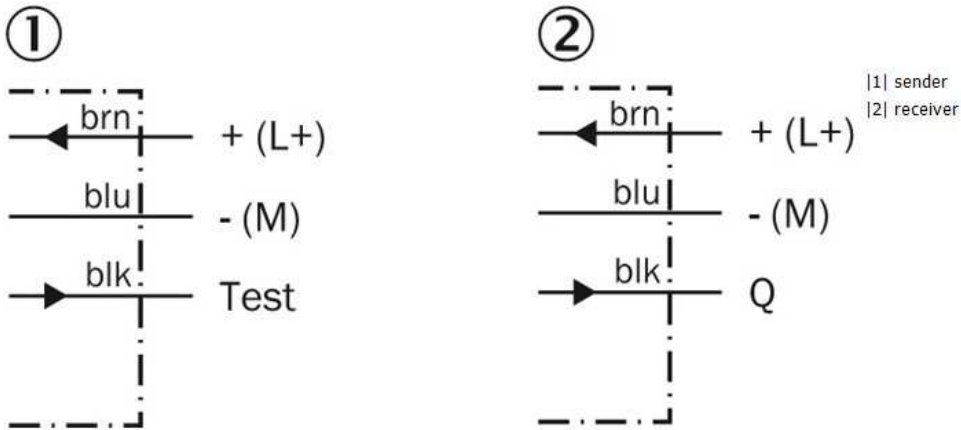

Characteristic curve

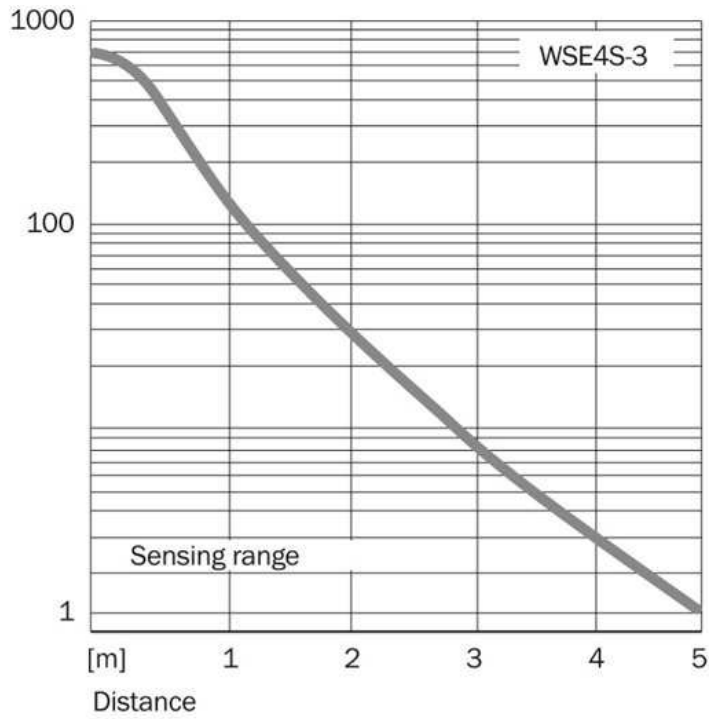

Sensing range diagram

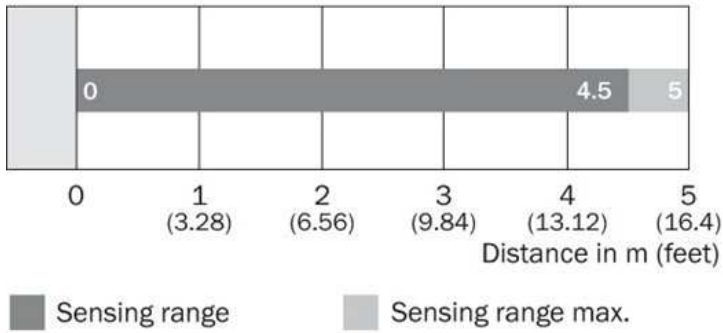

Connection type

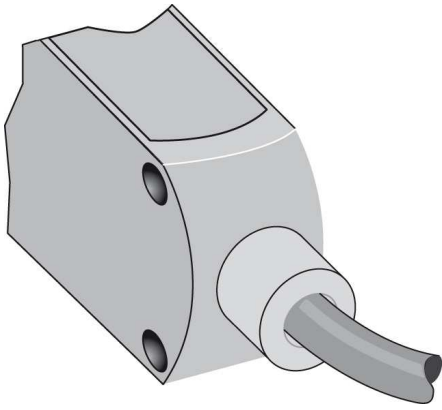

Australia

Phone +61 3 9457 0600
1800 33 48 02 – tollfree
E-Mail sales@sick.com.au

Belgium/Luxembourg

Phone +32 (0)2 466 55 66
E-Mail info@sick.be

Brasil

Phone +55 11 3215-4900
E-Mail marketing@sick.com.br

Canada

Phone +1 905 771 14 44
E-Mail information@sick.com

Česká republika

Phone +420 2 57 91 18 50
E-Mail sick@sick.cz

China

Phone +86 4000 121 000
E-Mail info.china@sick.net.cn
Phone +852-2153 6300
E-Mail ghk@sick.com.hk

Danmark

Phone +45 45 82 64 00
E-Mail sick@sick.dk

Deutschland

Phone +49 211 5301-301
E-Mail info@sick.de

España

Phone +34 93 480 31 00
E-Mail info@sick.es

France

Phone +33 1 64 62 35 00
E-Mail info@sick.fr

Great Britain

Phone +44 (0)1727 831121
E-Mail info@sick.co.uk

India

Phone +91-22-4033 8333
E-Mail info@sick-india.com

Israel

Phone +972-4-6881000
E-Mail info@sick-sensors.com

Italia

Phone +39 02 27 43 41
E-Mail info@sick.it

Japan

Phone +81 (0)3 5309 2112
E-Mail support@sick.jp

Magyarország

Phone +36 1 371 2680
E-Mail office@sick.hu

Nederland

Phone +31 (0)30 229 25 44
E-Mail info@sick.nl

Norge

Phone +47 67 81 50 00
E-Mail sick@sick.no

Österreich

Phone +43 (0)22 36 62 28 8-0
E-Mail office@sick.at

Polska

Phone +48 22 837 40 50
E-Mail info@sick.pl

România

Phone +40 356 171 120
E-Mail office@sick.ro

Russia

Phone +7-495-775-05-30
E-Mail info@sick.ru

Schweiz

Phone +41 41 619 29 39
E-Mail contact@sick.ch

Singapore

Phone +65 6744 3732
E-Mail sales.gsg@sick.com

Slovenija

Phone +386 (0)1-47 69 990
E-Mail office@sick.si

South Africa

Phone +27 11 472 3733
E-Mail info@sickautomation.co.za

South Korea

Phone +82 2 786 6321/4
E-Mail info@sickkorea.net

Suomi

Phone +358-9-25 15 800
E-Mail sick@sick.fi

Sverige

Phone +46 10 110 10 00
E-Mail info@sick.se

Taiwan

Phone +886 2 2375-6288
E-Mail sales@sick.com.tw

Türkiye

Phone +90 (216) 528 50 00
E-Mail info@sick.com.tr

United Arab Emirates

Phone +971 (0) 4 88 65 878
E-Mail info@sick.ae

USA/México

Phone +1(952) 941-6780
1 (800) 325-7425 – tollfree
E-Mail info@sickusa.com

More representatives and agencies
at www.sick.com