



**Absolute encoders  
AFS/AFM60 SSI**

AFM60B-S1AM004096

**Model Name** > **AFM60B-S1AM004096**  
**Part No.** > **1053154**



**At a glance**

- High-resolution absolute encoders with up to 30 bits (AFM60) or up to 18 bits (AFS60)
- Face mount flange, servo flange, blind or through hollow shaft
- SSI, SSI + Incremental or SSI + Sin/Cos interface
- Programmable resolution and offset (dependent on type)
- Connection system: M12, M23 connector or cable outlet
- Enclosure rating: IP 67 (housing), IP 65 (shaft)
- Operating temperature: -30 °C to +100 °C (depends on type)

**Your benefits**

- Programmability of the encoders means less storage, greater machine availability and easy installation
- Precise positioning due to high resolutions
- Large selection of mechanical interfaces and electrical contacting possibilities: Suitable for all applications
- Suitable for applications with limited space requirements (extremely short installation depth of 30 mm)
- Very good rotation accuracy due to increased bearing distance
- One programming tool and software with automatic encoder detection for AFS60/AFM60/DFS60



**Performance**

---

Max. number of steps per revolution:	4,096
Max. number of revolutions:	4,096
Resolution power:	4,096 x 4,096
Resolution:	12 bit x 12 bit
Error limits:	± 0.05 °
Repeatability (Ta not constant):	0.002 °
Measuring step deviation:	± 0.01 °
Measuring step:	0.01 °
Initialization time:	50 ms <sup>1)</sup>

<sup>1)</sup> Valid positional data can be read once this time has elapsed

**Mechanical data**

---

Mechanical interface:	Solid shaft, Servo flange
Shaft diameter:	6 mm

Start up torque:	0.5 Ncm (20 °C)
Operating torque:	0.3 Ncm (20 °C)
Permissible Load capacity of shaft:	40 N (axial), 80 N (radial)
Maximum operating speed:	9,000 /min <sup>1)</sup>
Moment of inertia of the rotor:	6.2 gcm <sup>2</sup>
Bearing lifetime:	3.0 x 10 <sup>9</sup> revolutions
Max. angular acceleration:	500,000 rad/s <sup>2</sup>

<sup>1)</sup> Self warming of 3.3 K per 1000 revolutions/min when applying note working temperature range

## Electrical data

---

Power consumption:	0.5 W (without load)
Operating voltage range:	4.5 V DC ... 32 V DC
MTTFd: mean time to dangerous failure:	250 a (EN ISO 13849-1) <sup>1)</sup>

<sup>1)</sup> This product is a standard product and does not constitute a safety component as defined in the Machinery Directive.

Calculation based on nominal load of components, average ambient

temperature 40°C, frequency of use 8760 h/a. All

electronic failures are considered hazardous. For more information, see document no. 8015532.

## Interfaces

---

Electrical interface:	Cable, 8-pin, universal, 5 m <sup>1)</sup>
Interface signals:	Clock +, Clock -, Data +, Data-
Clock frequency:	2 MHz <sup>2)</sup>
SET (electronic adjustment):	H-active (L ≡ 0 - 1,5 V, H ≡ 2,0 - Us V)
CW/CCW (counting sequence when turning):	L-active (L ≡ 0 - 1,5 V, H ≡ 2,0 - Us V)

<sup>1)</sup> The universal cable outlet is positioned in such a way, that it is possible to lay the cable in a radial or axial direction without kinking it<sup>2)</sup>

## Ambient data

---

EMC:	(according to EN 61000-6-2 and EN 61000-6-3) <sup>1)</sup>
Enclosure rating:	IP 65 (according to IEC 60529), shaft side, IP 67 (according to IEC 60529), housing side
Permissible relative humidity:	90 % (condensation of the optical scanning not permitted)
Working temperature range:	-30 °C ... 100 °C
Storage temperature range:	-40 °C ... 100 °C, without package
Resistance to shocks:	70 g (according to EN 60068-2-27)
Resistance to vibration:	30 g, 10 Hz ... 2,000 Hz (according to EN 60068-2-6)

<sup>1)</sup>

Dimensional drawing

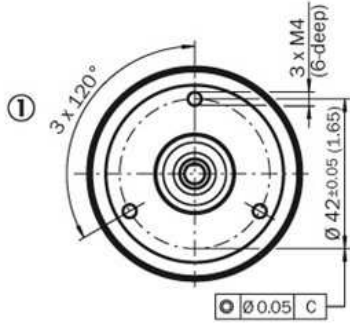
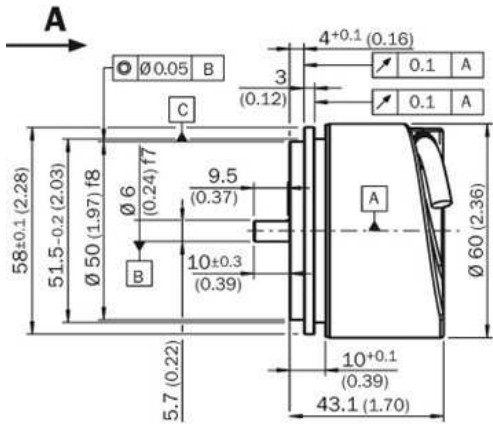

[1] Cable diameter = 5,6 mm  
 +/- 2 mm Bending radius = 30 mm

**Australia**

Phone +61 3 9457 0600  
1800 33 48 02 – tollfree  
E-Mail sales@sick.com.au

**Belgium/Luxembourg**

Phone +32 (0)2 466 55 66  
E-Mail info@sick.be

**Brasil**

Phone +55 11 3215-4900  
E-Mail marketing@sick.com.br

**Canada**

Phone +1 905 771 14 44  
E-Mail information@sick.com

**Česká republika**

Phone +420 2 57 91 18 50  
E-Mail sick@sick.cz

**China**

Phone +86 4000 121 000  
E-Mail info.china@sick.net.cn  
Phone +852-2153 6300  
E-Mail ghk@sick.com.hk

**Danmark**

Phone +45 45 82 64 00  
E-Mail sick@sick.dk

**Deutschland**

Phone +49 211 5301-301  
E-Mail info@sick.de

**España**

Phone +34 93 480 31 00  
E-Mail info@sick.es

**France**

Phone +33 1 64 62 35 00  
E-Mail info@sick.fr

**Great Britain**

Phone +44 (0)1727 831121  
E-Mail info@sick.co.uk

**India**

Phone +91-22-4033 8333  
E-Mail info@sick-india.com

**Israel**

Phone +972-4-6881000  
E-Mail info@sick-sensors.com

**Italia**

Phone +39 02 27 43 41  
E-Mail info@sick.it

**Japan**

Phone +81 (0)3 5309 2112  
E-Mail support@sick.jp

**Magyarország**

Phone +36 1 371 2680  
E-Mail office@sick.hu

**Nederland**

Phone +31 (0)30 229 25 44  
E-Mail info@sick.nl

**Norge**

Phone +47 67 81 50 00  
E-Mail sick@sick.no

**Österreich**

Phone +43 (0)22 36 62 28 8-0  
E-Mail office@sick.at

**Polska**

Phone +48 22 837 40 50  
E-Mail info@sick.pl

**România**

Phone +40 356 171 120  
E-Mail office@sick.ro

**Russia**

Phone +7-495-775-05-30  
E-Mail info@sick.ru

**Schweiz**

Phone +41 41 619 29 39  
E-Mail contact@sick.ch

**Singapore**

Phone +65 6744 3732  
E-Mail sales.gsg@sick.com

**Slovenija**

Phone +386 (0)1-47 69 990  
E-Mail office@sick.si

**South Africa**

Phone +27 11 472 3733  
E-Mail info@sickautomation.co.za

**South Korea**

Phone +82 2 786 6321/4  
E-Mail info@sickkorea.net

**Suomi**

Phone +358-9-25 15 800  
E-Mail sick@sick.fi

**Sverige**

Phone +46 10 110 10 00  
E-Mail info@sick.se

**Taiwan**

Phone +886 2 2375-6288  
E-Mail sales@sick.com.tw

**Türkiye**

Phone +90 (216) 528 50 00  
E-Mail info@sick.com.tr

**United Arab Emirates**

Phone +971 (0) 4 88 65 878  
E-Mail info@sick.ae

**USA/México**

Phone +1(952) 941-6780  
1 (800) 325-7425 – tollfree  
E-Mail info@sickusa.com

More representatives and agencies  
at [www.sick.com](http://www.sick.com)