



Magnetic Cylinder Sensors
Analog positioning sensors

MPS-224TSNPO



Model Name > [MPS-224TSNP0](#)
Part No. > [1053841](#)



At a glance

- Magnetic position sensor for pneumatic and hydraulic cylinders with T-slot
- Output signal: analog, 4 - 20 mA current and 0 -10 V (in one sensor)
- Superior precision: 0.05 mm resolution, 0.1 mm repeatability, 0.3 mm linearity, 1 ms measurement rate
- Various lengths available from 32 - 256 mm

Your benefits

- Maximum flexibility with several different measuring ranges from 32 to 256 mm
- Drop-in T-slot mounting from above makes assembly easy
- Selectable installation direction to optimize cabling
- Efficient measurement of stroke due to minimal blind zones, increasing machine throughput
- Simple commissioning due to "in-range" indicator
- Output signal: analog, 4 - 20 mA current and 0 -10 V (in one sensor) reduces inventory cost by part number reduction



Features

Output function:	Analog
Electrical wiring:	DC 4-wire
Teach-in:	0
Cylinder type:	T-slot
Cylinder types with adapter:	Roundbody cylinder SMC rail cylinder CDQ2 SMC rail cylinder ECDQ2 Cylinders with dovetail slots
Measurement range:	224 mm ¹⁾
Housing length:	237 mm
Analog output (voltage):	0 V ... 10 V
Analog output (current):	4 mA ... 20 mA
Enclosure rating:	IP 67 ²⁾

¹⁾ ± 1 mm ²⁾ According to EN 60529

Mechanics/electronics

Connection type:	Cable with connector M8, 4-pin, 0.3 m ¹⁾
Supply voltage:	15 V DC ... 30 V DC
EMC:	According to EN 60947-5-2 ²⁾

Load resistance, max.:	500 Ω ³⁾
Min. load resistance:	2 kΩ ⁴⁾
Cable material:	PUR
Conductor cross-section:	0.14 mm ²
Reverse polarity protection:	✓
Short-circuit protection:	✓
Housing material:	Plastic
Output indicator:	✓
Linearity typ.:	0.3 mm
Resolution typ.:	0.03 % FSR (max. ≥ 0.05 mm) ⁵⁾
Repeat accuracy typ.:	0.06 % FSR (≥ 0.1 mm) ⁶⁾
Shock and vibration resistance:	30 g, 11 ms/10 ... 55 Hz, 1 mm
Ambient operating temperature:	-20 °C ... 70 °C
Protection class:	III
Magnetic field sensitivity, typ.:	3 mT
Sampling rate typ.:	1 ms

1) Do not bend below 0 °C 2) The analog measured value can deviate under transient conditions 3) Power output 4) Voltage output 5) 6) FSR: Full Scale Range; max. measuring range

Dimensional drawing

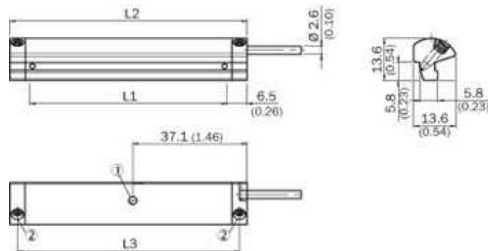

	Total length (L1) mm	Measuring range (L2) mm	Distance mounting screws (L3) mm
MPS-32	45	32	40
MPS-64	77	64	72
MPS-96	109	96	104
MPS-128	141	128	136
MPS-160	173	160	168
MPS-192	205	192	200
MPS-224	237	224	232
MPS-256	269	256	264

|1| Function signal indicator
|2| Fixing screw

Connection diagram

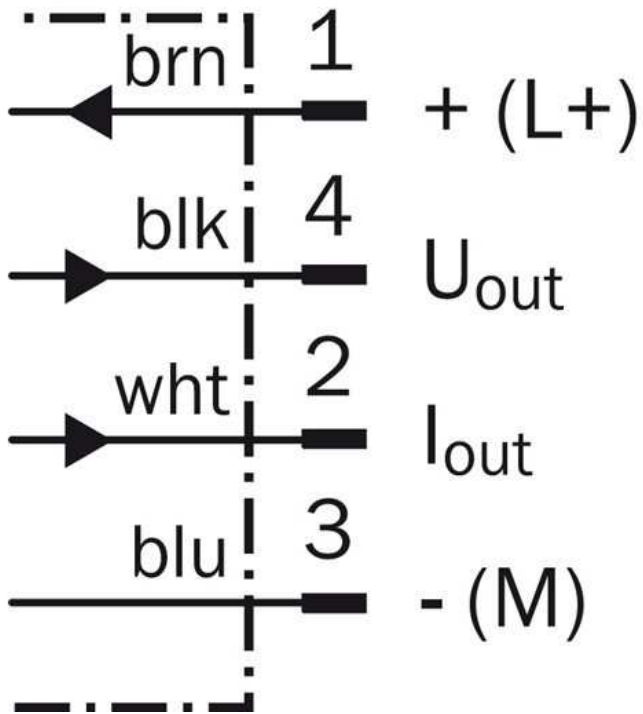

Connection type



Australia

Phone +61 3 9457 0600
1800 33 48 02 – tollfree
E-Mail sales@sick.com.au

Belgium/Luxembourg

Phone +32 (0)2 466 55 66
E-Mail info@sick.be

Brasil

Phone +55 11 3215-4900
E-Mail marketing@sick.com.br

Canada

Phone +1 905 771 14 44
E-Mail information@sick.com

Česká republika

Phone +420 2 57 91 18 50
E-Mail sick@sick.cz

China

Phone +86 4000 121 000
E-Mail info.china@sick.net.cn
Phone +852-2153 6300
E-Mail ghk@sick.com.hk

Danmark

Phone +45 45 82 64 00
E-Mail sick@sick.dk

Deutschland

Phone +49 211 5301-301
E-Mail info@sick.de

España

Phone +34 93 480 31 00
E-Mail info@sick.es

France

Phone +33 1 64 62 35 00
E-Mail info@sick.fr

Great Britain

Phone +44 (0)1727 831121
E-Mail info@sick.co.uk

India

Phone +91-22-4033 8333
E-Mail info@sick-india.com

Israel

Phone +972-4-6881000
E-Mail info@sick-sensors.com

Italia

Phone +39 02 27 43 41
E-Mail info@sick.it

Japan

Phone +81 (0)3 5309 2112
E-Mail support@sick.jp

Magyarország

Phone +36 1 371 2680
E-Mail office@sick.hu

Nederland

Phone +31 (0)30 229 25 44
E-Mail info@sick.nl

Norge

Phone +47 67 81 50 00
E-Mail sick@sick.no

Österreich

Phone +43 (0)22 36 62 28 8-0
E-Mail office@sick.at

Polska

Phone +48 22 837 40 50
E-Mail info@sick.pl

România

Phone +40 356 171 120
E-Mail office@sick.ro

Russia

Phone +7-495-775-05-30
E-Mail info@sick.ru

Schweiz

Phone +41 41 619 29 39
E-Mail contact@sick.ch

Singapore

Phone +65 6744 3732
E-Mail sales.gsg@sick.com

Slovenija

Phone +386 (0)1-47 69 990
E-Mail office@sick.si

South Africa

Phone +27 11 472 3733
E-Mail info@sickautomation.co.za

South Korea

Phone +82 2 786 6321/4
E-Mail info@sickkorea.net

Suomi

Phone +358-9-25 15 800
E-Mail sick@sick.fi

Sverige

Phone +46 10 110 10 00
E-Mail info@sick.se

Taiwan

Phone +886 2 2375-6288
E-Mail sales@sick.com.tw

Türkiye

Phone +90 (216) 528 50 00
E-Mail info@sick.com.tr

United Arab Emirates

Phone +971 (0) 4 88 65 878
E-Mail info@sick.ae

USA/México

Phone +1(952) 941-6780
1 (800) 325-7425 – tollfree
E-Mail info@sickusa.com

More representatives and agencies
at www.sick.com