



Motor feedback systems rotary HIPERFACE
DSL®
EKS/EKM36

EKM36-OKFOA020A



Model Name > [EKM36-0KF0A020A](#)
Part No. > [1053857](#)



Illustration may differ

At a glance

- Motor feedback system with HIPERFACE DSL® interface
- Compact, robust design with 36 mm diameter
- Up to 20 bit resolution per revolution and 4,096 revolutions measurable with the multiturn system
- Facility for connecting an external temperature sensor
- E²Prom with 8 kbyte of free memory space
- SIL2-certified (only valid for EKS/EKM36-2...)
- Service life histogram

Your benefits

- Saving all analog components on the controller part through exclusively digital data transmission
- Enormous cost saving thanks to the separate encoder cable no longer being necessary, data transmitted synchronously to the controller cycle
- Minimal cabling thanks to integration of the encoder communication into the motor cable
- Optimization of the controller circuit via automatic synchronization with the controller cycle



Performance

Number of the absolute ascertainable revolutions: Multiturn
Available memory area: 8,192 Byte ¹⁾

¹⁾ If applying the electronic type label, in connection with numeric controllers, attention should be paid to Patent EP 425 912 B2; Application of the electronic type label in connection with speed regulation is exempt.

Mechanical data

Flange type/stator coupling:	Spring mounting plate, Ø 36
Moment of inertia of the rotor:	4.5 gcm ²
Operating torque:	0.2 Ncm
Start up torque:	0.3 Ncm
Permissible shaft movement, radial, static:	± 0.1 mm
Permissible shaft movement, radial, dynamic:	± 0.05 mm
Permissible shaft movement, axial, static:	± 0.5 mm
Permissible shaft movement, axial, dynamic:	± 0.1 mm
Maximum operating speed:	9,000 U/min

Electrical data

Electrical interface: HIPERFACE DSL

Ambient data

Working temperature range: -20 °C ... 115 °C
Storage temperature range: -40 °C ... 125 °C
Relative humidity/Condensation: Condensation not permitted
Resistance to shocks: 100 g (EN 60068-2-27)
Resistance to vibration: 50 g, 10 Hz ... 2,000 Hz (EN 60068-2-6)
Enclosure rating: IP 40

Dimensional drawing

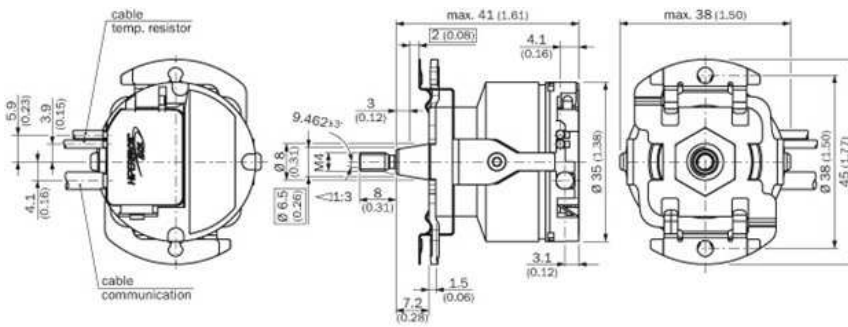

Proposed fitting

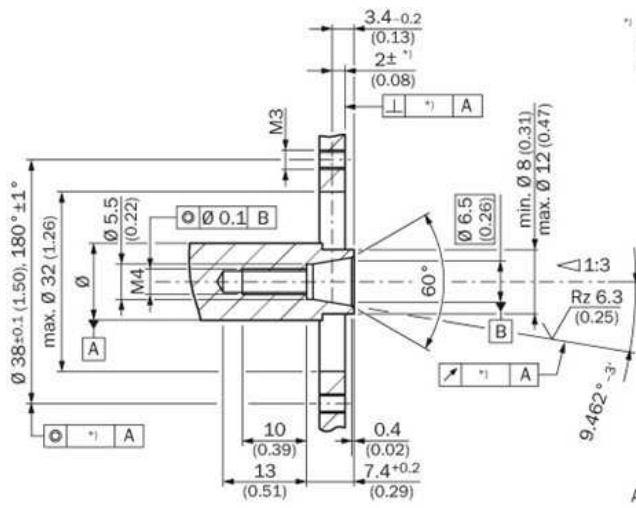

*1 Size of tolerance reduce the allowed movement of the shaft see data sheet.

All dimensions in mm (inch)

Australia

Phone +61 3 9457 0600
1800 33 48 02 – tollfree
E-Mail sales@sick.com.au

Belgium/Luxembourg

Phone +32 (0)2 466 55 66
E-Mail info@sick.be

Brasil

Phone +55 11 3215-4900
E-Mail marketing@sick.com.br

Canada

Phone +1 905 771 14 44
E-Mail information@sick.com

Česká republika

Phone +420 2 57 91 18 50
E-Mail sick@sick.cz

China

Phone +86 4000 121 000
E-Mail info.china@sick.net.cn
Phone +852-2153 6300
E-Mail ghk@sick.com.hk

Danmark

Phone +45 45 82 64 00
E-Mail sick@sick.dk

Deutschland

Phone +49 211 5301-301
E-Mail info@sick.de

España

Phone +34 93 480 31 00
E-Mail info@sick.es

France

Phone +33 1 64 62 35 00
E-Mail info@sick.fr

Great Britain

Phone +44 (0)1727 831121
E-Mail info@sick.co.uk

India

Phone +91-22-4033 8333
E-Mail info@sick-india.com

Israel

Phone +972-4-6881000
E-Mail info@sick-sensors.com

Italia

Phone +39 02 27 43 41
E-Mail info@sick.it

Japan

Phone +81 (0)3 5309 2112
E-Mail support@sick.jp

Magyarország

Phone +36 1 371 2680
E-Mail office@sick.hu

Nederland

Phone +31 (0)30 229 25 44
E-Mail info@sick.nl

Norge

Phone +47 67 81 50 00
E-Mail sick@sick.no

Österreich

Phone +43 (0)22 36 62 28 8-0
E-Mail office@sick.at

Polska

Phone +48 22 837 40 50
E-Mail info@sick.pl

România

Phone +40 356 171 120
E-Mail office@sick.ro

Russia

Phone +7-495-775-05-30
E-Mail info@sick.ru

Schweiz

Phone +41 41 619 29 39
E-Mail contact@sick.ch

Singapore

Phone +65 6744 3732
E-Mail sales.gsg@sick.com

Slovenija

Phone +386 (0)1-47 69 990
E-Mail office@sick.si

South Africa

Phone +27 11 472 3733
E-Mail info@sickautomation.co.za

South Korea

Phone +82 2 786 6321/4
E-Mail info@sickkorea.net

Suomi

Phone +358-9-25 15 800
E-Mail sick@sick.fi

Sverige

Phone +46 10 110 10 00
E-Mail info@sick.se

Taiwan

Phone +886 2 2375-6288
E-Mail sales@sick.com.tw

Türkiye

Phone +90 (216) 528 50 00
E-Mail info@sick.com.tr

United Arab Emirates

Phone +971 (0) 4 88 65 878
E-Mail info@sick.ae

USA/México

Phone +1(952) 941-6780
1 (800) 325-7425 – tollfree
E-Mail info@sickusa.com

More representatives and agencies
at www.sick.com