



Photoelectric sensors
W9-3, Through-beam photoelectric sensor

WSE9-3N2230



Model Name > [WSE9-3N2230](#)
Part No. > [1055041](#)



Illustration may differ

At a glance

- High-performance through-beam sensor in ultra-rugged VISTAL™ housing
- PinPoint LED for highly visible and precise light spot
- Variable mounting with M3 hole pattern
- Wide range of connection options

Your benefits

- Rugged VISTAL™ housing provides reliable installation and operation
- Reliable object detection in all situations using best-in-class optics
- Quick and easy alignment with reliable object detection due to the highly visible PinPoint light spot
- M3 slotted hole mounting for multiple mounting possibilities
- One housing with a wide range of options makes machine integration easy
- Variety of accessories for simple mounting



Features

Sensor/detection principle:	Through-beam photoelectric sensor
Dimensions (W x H x D):	12.2 mm x 49.8 mm x 23.6 mm
Housing design (light emission):	Rectangular
Mounting hole:	M3
Sensing range max.:	0 m ... 10 m
Sensing range:	0 m ... 7 m
Type of light:	Visible red light
Light source:	PinPoint LED ¹⁾
Adjustment:	No adjustment
Light spot size (distance):	Ø 25 mm (1 m)

¹⁾ Average service life of 100,000 h at T_A = +25 °C

Mechanics/electronics

Supply voltage:	10 V DC ... 30 V DC ¹⁾
Ripple:	< 5 Vpp ²⁾
Power consumption:	≤ 30 mA ³⁾
Output type:	NPN ⁴⁾
Switching mode:	Light/dark switching ⁵⁾
Output current I _{max.} :	≤ 100 mA ⁶⁾
Response time:	< 0.5 ms ⁷⁾

Switching frequency:	1,000 Hz ⁸⁾
Connection type:	Connector M8, 4-pin
Circuit protection:::	A, B, C ⁹⁾ ¹⁰⁾ ¹¹⁾
Protection class:	III
Weight:	13 g
Polarisation filter:	-
Optics material:	PMMA
Enclosure rating:	IP 66 IP 67 IP 69K
Test input sender off:	Sender off
Ambient operating temperature:	-40 °C ... +60 °C
Ambient storage temperature:	-40 °C ... +75 °C
Part number of individual components:	Receiver, WE9-3N2230, 2061183, Sender, WS9-3D2230, 2055821
UL File No.:	NRKH.E181493
Housing material:	Plastic, VISTAL

1) Limit values, operation in short-circuit protected network max. 8 A ²⁾ May not exceed or fall short of V_S tolerances ³⁾ Without load ^{4) 5)} Q = light-switching ⁶⁾ As of Tu 50 °C, a max. load current $I_{max.} = 50$ mA is permitted ⁷⁾ Signal transit time with resistive load ⁸⁾ With light/dark ratio 1:1 ⁹⁾ A = V_S connections reverse-polarity protected ¹⁰⁾ B = inputs and output reverse-polarity protected ¹¹⁾ C = interference suppression

Dimensional drawing

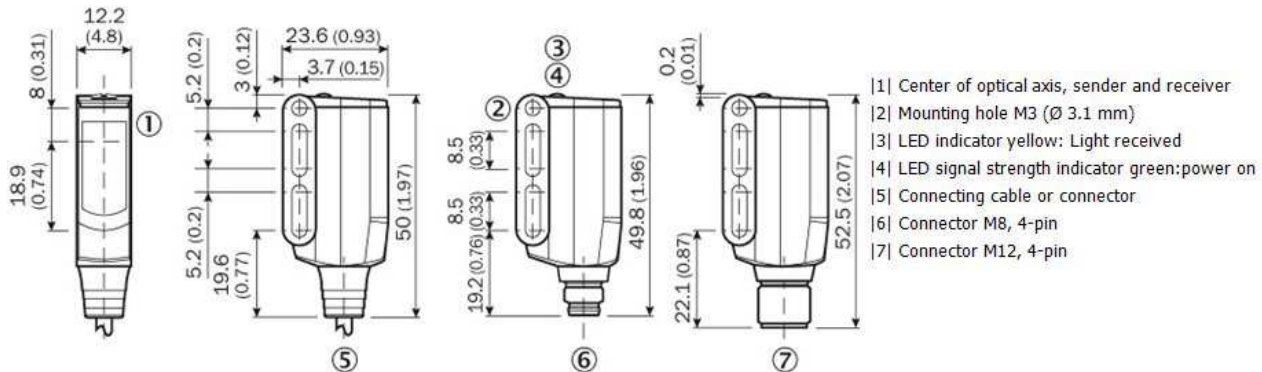

Adjustments possible



|3| LED indicator yellow: Light received
|4| LED signal strength indicator green:power on

Connection diagram

①

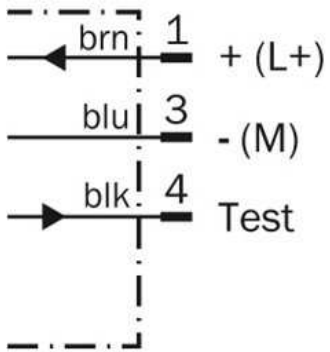

②

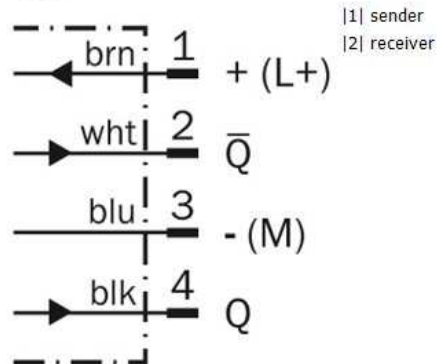

Characteristic curve

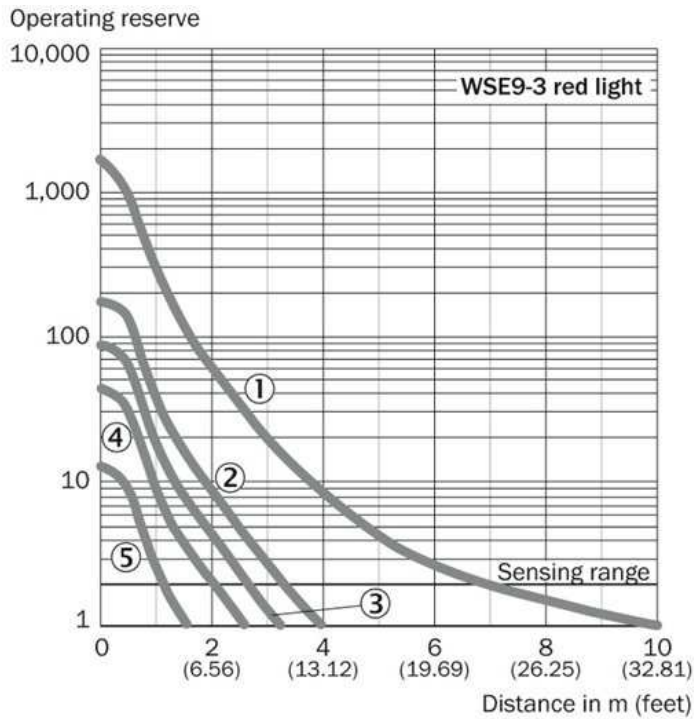

- |1| Without masks
- |2| With slotted mask, width 2.0 mm
- |3| With slotted mask, width 1.5 mm
- |4| With slotted mask, width 1.0 mm
- |5| With slotted mask, width 0.5 mm

Sensing range diagram

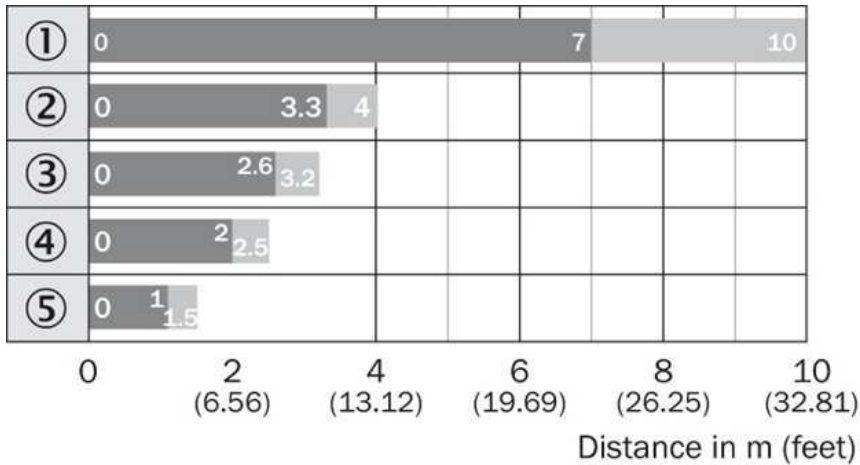

- |1| Without masks
- |2| With slotted mask, width 2.0 mm
- |3| With slotted mask, width 1.5 mm
- |4| With slotted mask, width 1.0 mm
- |5| With slotted mask, width 0.5 mm

■ Sensing range

■ Sensing range, max. typ.

Connection type

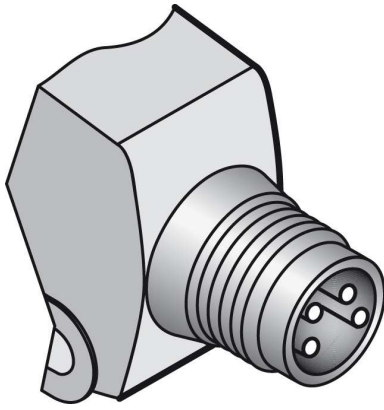

Light spot size

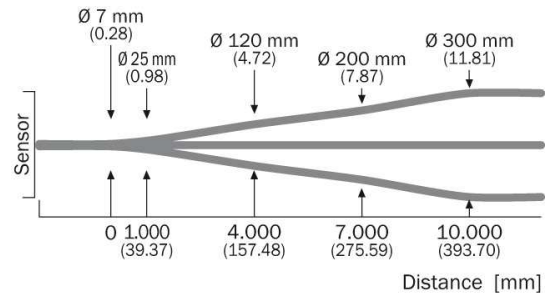

Australia

Phone +61 3 9457 0600
1800 33 48 02 – tollfree
E-Mail sales@sick.com.au

Belgium/Luxembourg

Phone +32 (0)2 466 55 66
E-Mail info@sick.be

Brasil

Phone +55 11 3215-4900
E-Mail marketing@sick.com.br

Canada

Phone +1 905 771 14 44
E-Mail information@sick.com

Česká republika

Phone +420 2 57 91 18 50
E-Mail sick@sick.cz

China

Phone +86 4000 121 000
E-Mail info.china@sick.net.cn
Phone +852-2153 6300
E-Mail ghk@sick.com.hk

Danmark

Phone +45 45 82 64 00
E-Mail sick@sick.dk

Deutschland

Phone +49 211 5301-301
E-Mail info@sick.de

España

Phone +34 93 480 31 00
E-Mail info@sick.es

France

Phone +33 1 64 62 35 00
E-Mail info@sick.fr

Great Britain

Phone +44 (0)1727 831121
E-Mail info@sick.co.uk

India

Phone +91-22-4033 8333
E-Mail info@sick-india.com

Israel

Phone +972-4-6881000
E-Mail info@sick-sensors.com

Italia

Phone +39 02 27 43 41
E-Mail info@sick.it

Japan

Phone +81 (0)3 5309 2112
E-Mail support@sick.jp

Magyarország

Phone +36 1 371 2680
E-Mail office@sick.hu

Nederland

Phone +31 (0)30 229 25 44
E-Mail info@sick.nl

Norge

Phone +47 67 81 50 00
E-Mail sick@sick.no

Österreich

Phone +43 (0)22 36 62 28 8-0
E-Mail office@sick.at

Polska

Phone +48 22 837 40 50
E-Mail info@sick.pl

România

Phone +40 356 171 120
E-Mail office@sick.ro

Russia

Phone +7-495-775-05-30
E-Mail info@sick.ru

Schweiz

Phone +41 41 619 29 39
E-Mail contact@sick.ch

Singapore

Phone +65 6744 3732
E-Mail sales.gsg@sick.com

Slovenija

Phone +386 (0)1-47 69 990
E-Mail office@sick.si

South Africa

Phone +27 11 472 3733
E-Mail info@sickautomation.co.za

South Korea

Phone +82 2 786 6321/4
E-Mail info@sickkorea.net

Suomi

Phone +358-9-25 15 800
E-Mail sick@sick.fi

Sverige

Phone +46 10 110 10 00
E-Mail info@sick.se

Taiwan

Phone +886 2 2375-6288
E-Mail sales@sick.com.tw

Türkiye

Phone +90 (216) 528 50 00
E-Mail info@sick.com.tr

United Arab Emirates

Phone +971 (0) 4 88 65 878
E-Mail info@sick.ae

USA/México

Phone +1(952) 941-6780
1 (800) 325-7425 – tollfree
E-Mail info@sickusa.com

More representatives and agencies
at www.sick.com