



Level sensors  
TDR level sensor

LFP1100-A4NMB



**Model Name** > LFP1100-A4NMB  
**Part No.** > 1057082



*Illustration may differ*

**At a glance**

- Level sensor for fluids
- No mechanical moving parts
- Manually cuttable and exchangeable probe with lengths from 200 mm up to 2,000 mm or rope probe up to 4,000 mm
- Resistant to deposit formation
- Process temperature up to 100 °C; process pressure up to 10 bar
- 3 in 1: combined display, analog output (acc. NAMUR NE 43) and binary output
- High enclosure rating of IP 67, rotatable housing and remote amplifier version

**Your benefits**

- Rugged design increases service life
- High flexibility due to cuttable and exchangeable monoprobe or rope probe
- Cost savings due to multiple output signals: one system for both level detection and continuous level monitoring
- Time and cost savings due to low maintenance and quick commissioning without calibration
- Titanium process connection brings high chemical resistance
- Compact and rotatable housing or remote amplifier ensures flexible installation
- No crosstalk when several sensors are mounted next to each other
- Advanced technology enables adjustment-free measurement



**Features**

Medium:	Fluids
Measurement:	Switch, Continuous
Probe type:	Mono rod probe
Probe length:	1,100 mm
Process pressure:	-1 bar ... 10 bar
Process temperature:	-20 °C ... +100 °C
GOST approval:	✓
CULus certificate:	✓
RoHS certificate:	✓
IO-Link:	✓
Design:	Standard

**Performance**

Maximum level change:	500 mm/s
Resolution:	< 2 mm

Accuracy of sensor element:	$\pm 5 \text{ mm}$ <sup>1)</sup>
Repeatability:	$\leq 2 \text{ mm}$
Dielectricity constant:	$\geq 1.8$ with coaxial tube, $\geq 5$ for mono rod probe/rope probe
Inactive area at process connector:	$25 \text{ mm}$ <sup>2)</sup>
Inactive area at probe end:	$10 \text{ mm}$ <sup>3)</sup>
Conductivity:	No limitation
Response time:	$< 400 \text{ ms}$
MTTF:	194.3 a (EN ISO 13849-1)

1) <sup>3)</sup> With water under reference conditions    <sup>2)</sup> With parameterized tank with water under reference conditions, otherwise 40 mm

### Mechanical data

---

Housing material:	Plastic PBT
Max.probe load:	6 Nm
Process connection:	G $\frac{3}{4}$ A
Wetted parts:	1.4404, PTFE

### Electrical data

---

Temperature drift:	$< 0.1 \text{ mm/K}$
Enclosure rating:	IP 67: EN 60529
Supply voltage:	12 V DC ... 30 V DC <sup>1)</sup>
Power consumption:	$\leq 100 \text{ mA}$ at 24 V DC without output load
Protection class:	III
Initialization time:	$\leq 5 \text{ s}$
Output signal:	1 PNP transistor output (Q1) and 1 PNP/NPN transistor output (Q2) switchable, 4 mA ... 20 mA, 0 V ... 10 V automatic switching depending on the load.
Output load:	0 V ... 10 V $> 750 \text{ Ohm}$ at $U_v \geq 14 \text{ V}$ , 4 mA ... 20 mA $< 350 \text{ Ohm}$ at $U_v > 12 \text{ V}$ , 4 mA ... 20 mA $< 500 \text{ Ohm}$ at $U_v > 15 \text{ V}$
Upper signal level:	20 mA ... 20.5 mA
Lower signal level:	3.8 mA ... 4 mA
Hysteresis:	Min. 2 mm, free adjustable
Output current:	$< 100 \text{ mA}$
Signal voltage HIGH:	$V_s - 2 \text{ V}$
Signal voltage LOW:	$\leq 2 \text{ V}$
Capacitive load:	100 nF
Inductive load:	$< 1 \text{ H}$
Connection type:	Round connector M12 x 1, 5-pin
EMC:	EN 61326-1:2006, 2004/108/EG

<sup>1)</sup> All connections are polarity protected. All outputs are overload and short-circuit protected.

### Ambient data

---

Ambient operating temperature:	$-20 \text{ }^\circ\text{C} \dots +60 \text{ }^\circ\text{C}$
Ambient storage temperature:	$-40 \text{ }^\circ\text{C} \dots +80 \text{ }^\circ\text{C}$

**Dimensional drawing: mono rod probe**

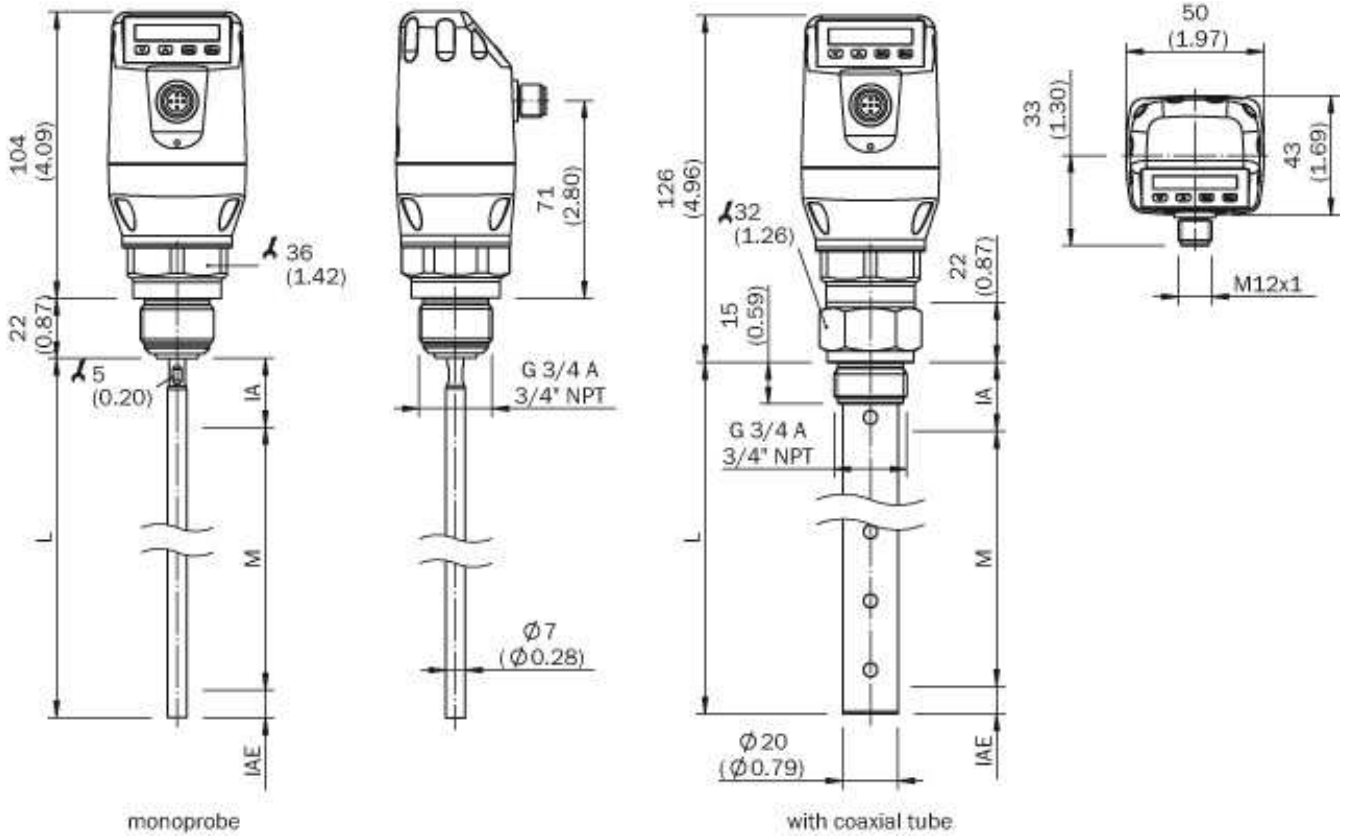

**Connection type**

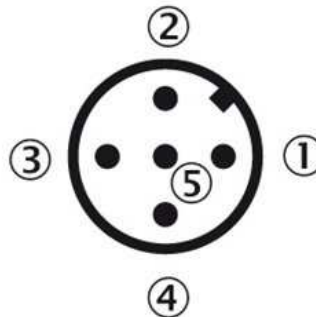

- |1| L+: Supply voltage, brown
- |2| QA: Analog current-/voltage output, white
- |3| M: Ground, reference ground  
for current-/voltage output, blue
- |4| C/Q1: Switching output 1,  
PNP/IO-Link-communication, black
- |5| Q2: Switching output 2, PNP/NPN, grey

**Australia**

Phone +61 3 9457 0600  
1800 33 48 02 – tollfree  
E-Mail sales@sick.com.au

**Belgium/Luxembourg**

Phone +32 (0)2 466 55 66  
E-Mail info@sick.be

**Brasil**

Phone +55 11 3215-4900  
E-Mail marketing@sick.com.br

**Canada**

Phone +1 905 771 14 44  
E-Mail information@sick.com

**Česká republika**

Phone +420 2 57 91 18 50  
E-Mail sick@sick.cz

**China**

Phone +86 4000 121 000  
E-Mail info.china@sick.net.cn  
Phone +852-2153 6300  
E-Mail ghk@sick.com.hk

**Danmark**

Phone +45 45 82 64 00  
E-Mail sick@sick.dk

**Deutschland**

Phone +49 211 5301-301  
E-Mail info@sick.de

**España**

Phone +34 93 480 31 00  
E-Mail info@sick.es

**France**

Phone +33 1 64 62 35 00  
E-Mail info@sick.fr

**Great Britain**

Phone +44 (0)1727 831121  
E-Mail info@sick.co.uk

**India**

Phone +91-22-4033 8333  
E-Mail info@sick-india.com

**Israel**

Phone +972-4-6881000  
E-Mail info@sick-sensors.com

**Italia**

Phone +39 02 27 43 41  
E-Mail info@sick.it

**Japan**

Phone +81 (0)3 5309 2112  
E-Mail support@sick.jp

**Magyarország**

Phone +36 1 371 2680  
E-Mail office@sick.hu

**Nederland**

Phone +31 (0)30 229 25 44  
E-Mail info@sick.nl

**Norge**

Phone +47 67 81 50 00  
E-Mail sick@sick.no

**Österreich**

Phone +43 (0)22 36 62 28 8-0  
E-Mail office@sick.at

**Polska**

Phone +48 22 837 40 50  
E-Mail info@sick.pl

**România**

Phone +40 356 171 120  
E-Mail office@sick.ro

**Russia**

Phone +7-495-775-05-30  
E-Mail info@sick.ru

**Schweiz**

Phone +41 41 619 29 39  
E-Mail contact@sick.ch

**Singapore**

Phone +65 6744 3732  
E-Mail sales.gsg@sick.com

**Slovenija**

Phone +386 (0)1-47 69 990  
E-Mail office@sick.si

**South Africa**

Phone +27 11 472 3733  
E-Mail info@sickautomation.co.za

**South Korea**

Phone +82 2 786 6321/4  
E-Mail info@sickkorea.net

**Suomi**

Phone +358-9-25 15 800  
E-Mail sick@sick.fi

**Sverige**

Phone +46 10 110 10 00  
E-Mail info@sick.se

**Taiwan**

Phone +886 2 2375-6288  
E-Mail sales@sick.com.tw

**Türkiye**

Phone +90 (216) 528 50 00  
E-Mail info@sick.com.tr

**United Arab Emirates**

Phone +971 (0) 4 88 65 878  
E-Mail info@sick.ae

**USA/México**

Phone +1(952) 941-6780  
1 (800) 325-7425 – tollfree  
E-Mail info@sickusa.com

More representatives and agencies  
at [www.sick.com](http://www.sick.com)