



Level sensors
TDR level sensor

LFP1900-B4NMB



Model Name > LFP1900-B4NMB
Part No. > 1057109



Illustration may differ

At a glance

- Level sensor for fluids
- No mechanical moving parts
- Manually cuttable and exchangeable probe with lengths from 200 mm up to 2,000 mm or rope probe up to 4,000 mm
- Resistant to deposit formation
- Process temperature up to 100 °C; process pressure up to 10 bar
- 3 in 1: combined display, analog output (acc. NAMUR NE 43) and binary output
- High enclosure rating of IP 67, rotatable housing and remote amplifier version

Your benefits

- Rugged design increases service life
- High flexibility due to cuttable and exchangeable monoprobe or rope probe
- Cost savings due to multiple output signals: one system for both level detection and continuous level monitoring
- Time and cost savings due to low maintenance and quick commissioning without calibration
- Titanium process connection brings high chemical resistance
- Compact and rotatable housing or remote amplifier ensures flexible installation
- No crosstalk when several sensors are mounted next to each other
- Advanced technology enables adjustment-free measurement



Features

| | |
|----------------------|--------------------|
| Medium: | Fluids |
| Measurement: | Switch, Continuous |
| Probe type: | Mono rod probe |
| Probe length: | 1,900 mm |
| Process pressure: | -1 bar ... 10 bar |
| Process temperature: | -20 °C ... +100 °C |
| GOST approval: | ✓ |
| CULus certificate: | ✓ |
| RoHS certificate: | ✓ |
| IO-Link: | ✓ |
| Design: | Standard |

Performance

| | |
|-----------------------|----------|
| Maximum level change: | 500 mm/s |
| Resolution: | < 2 mm |

| | |
|-------------------------------------|--|
| Accuracy of sensor element: | $\pm 5 \text{ mm}$ ¹⁾ |
| Repeatability: | $\leq 2 \text{ mm}$ |
| Dielectricity constant: | ≥ 1.8 with coaxial tube, ≥ 5 for mono rod probe/rope probe |
| Inactive area at process connector: | 25 mm ²⁾ |
| Inactive area at probe end: | 10 mm ³⁾ |
| Conductivity: | No limitation |
| Response time: | $< 400 \text{ ms}$ |
| MTTF: | 194.3 a (EN ISO 13849-1) |

1) ³⁾ With water under reference conditions ²⁾ With parameterized tank with water under reference conditions, otherwise 40 mm

Mechanical data

| | |
|---------------------|---------------------|
| Housing material: | Plastic PBT |
| Max.probe load: | 6 Nm |
| Process connection: | $\frac{3}{4}$ " NPT |
| Wetted parts: | 1.4404, PTFE |

Electrical data

| | |
|----------------------|---|
| Temperature drift: | $< 0.1 \text{ mm/K}$ |
| Enclosure rating: | IP 67: EN 60529 |
| Supply voltage: | 12 V DC ... 30 V DC ¹⁾ |
| Power consumption: | $\leq 100 \text{ mA}$ at 24 V DC without output load |
| Protection class: | III |
| Initialization time: | $\leq 5 \text{ s}$ |
| Output signal: | 1 PNP transistor output (Q1) and 1 PNP/NPN transistor output (Q2) switchable, 4 mA ... 20 mA, 0 V ... 10 V automatic switching depending on the load. |
| Output load: | 0 V ... 10 V $> 750 \text{ Ohm}$ at $U_v \geq 14 \text{ V}$, 4 mA ... 20 mA $< 350 \text{ Ohm}$ at $U_v > 12 \text{ V}$, 4 mA ... 20 mA $< 500 \text{ Ohm}$ at $U_v > 15 \text{ V}$ |
| Upper signal level: | 20 mA ... 20.5 mA |
| Lower signal level: | 3.8 mA ... 4 mA |
| Hysteresis: | Min. 2 mm, free adjustable |
| Output current: | $< 100 \text{ mA}$ |
| Signal voltage HIGH: | $V_s - 2 \text{ V}$ |
| Signal voltage LOW: | $\leq 2 \text{ V}$ |
| Capacitive load: | 100 nF |
| Inductive load: | $< 1 \text{ H}$ |
| Connection type: | Round connector M12 x 1, 5-pin |
| EMC: | EN 61326-1:2006, 2004/108/EG |

¹⁾ All connections are polarity protected. All outputs are overload and short-circuit protected.

Ambient data

| | |
|--------------------------------|---|
| Ambient operating temperature: | $-20 \text{ }^\circ\text{C} \dots +60 \text{ }^\circ\text{C}$ |
| Ambient storage temperature: | $-40 \text{ }^\circ\text{C} \dots +80 \text{ }^\circ\text{C}$ |

Dimensional drawing: mono rod probe

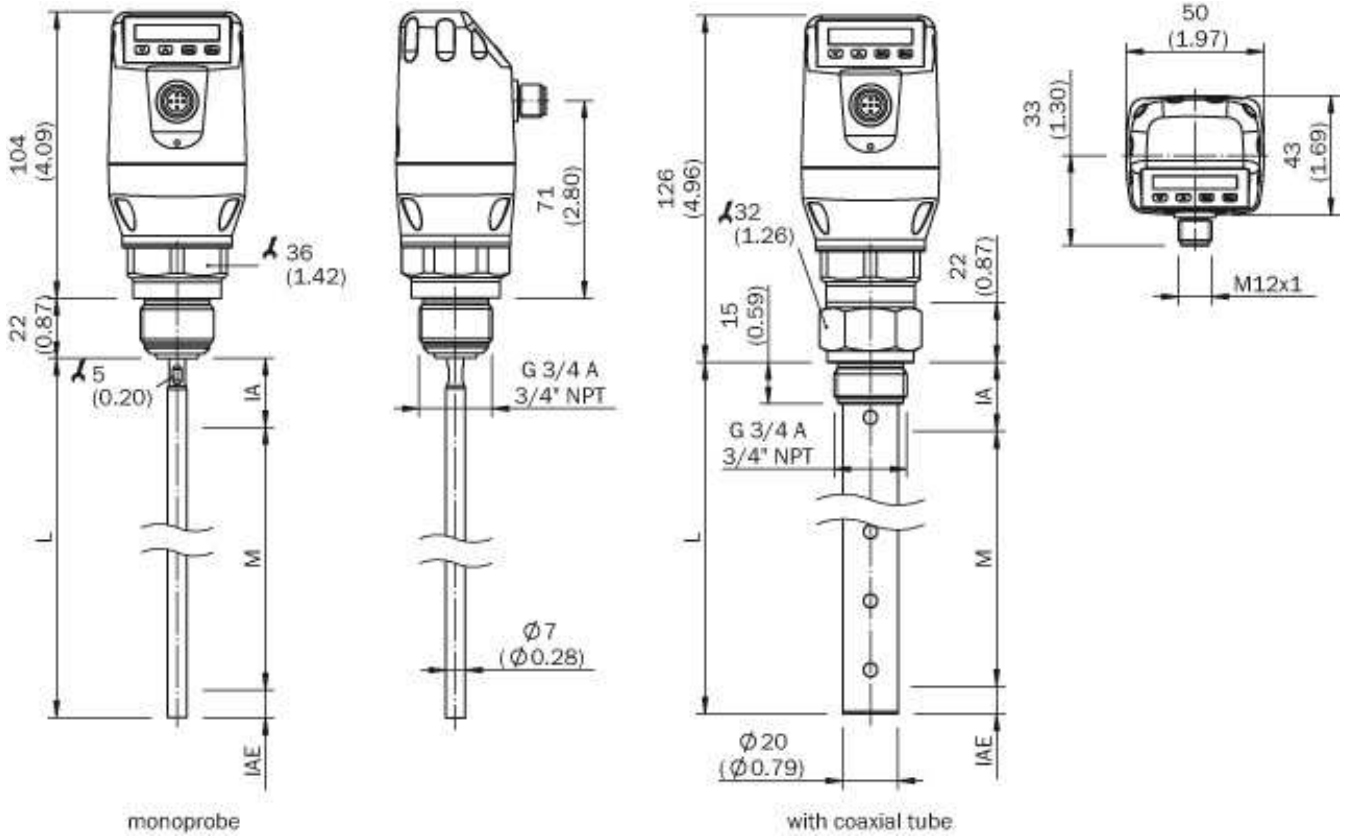

Connection type

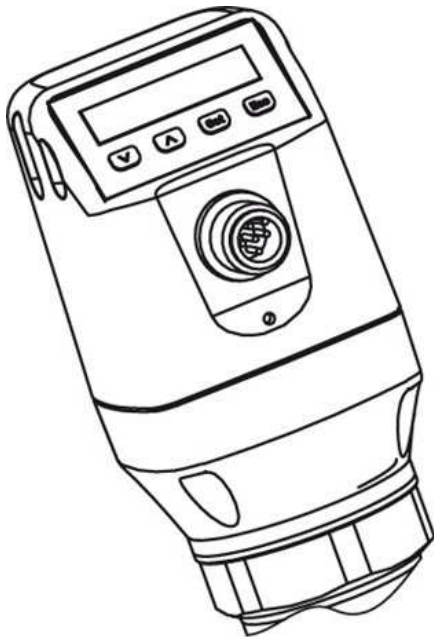

- |1| L+: Supply voltage, brown
- |2| QA: Analog current-/voltage output, white
- |3| M: Ground, reference ground for current-/voltage output, blue
- |4| C/Q1: Switching output 1, PNP/IO-Link-communication, black
- |5| Q2: Switching output 2, PNP/NPN, grey

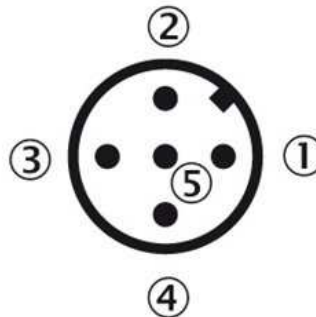

Australia

Phone +61 3 9457 0600
1800 33 48 02 – tollfree
E-Mail sales@sick.com.au

Belgium/Luxembourg

Phone +32 (0)2 466 55 66
E-Mail info@sick.be

Brasil

Phone +55 11 3215-4900
E-Mail marketing@sick.com.br

Canada

Phone +1 905 771 14 44
E-Mail information@sick.com

Česká republika

Phone +420 2 57 91 18 50
E-Mail sick@sick.cz

China

Phone +86 4000 121 000
E-Mail info.china@sick.net.cn
Phone +852-2153 6300
E-Mail ghk@sick.com.hk

Danmark

Phone +45 45 82 64 00
E-Mail sick@sick.dk

Deutschland

Phone +49 211 5301-301
E-Mail info@sick.de

España

Phone +34 93 480 31 00
E-Mail info@sick.es

France

Phone +33 1 64 62 35 00
E-Mail info@sick.fr

Great Britain

Phone +44 (0)1727 831121
E-Mail info@sick.co.uk

India

Phone +91-22-4033 8333
E-Mail info@sick-india.com

Israel

Phone +972-4-6881000
E-Mail info@sick-sensors.com

Italia

Phone +39 02 27 43 41
E-Mail info@sick.it

Japan

Phone +81 (0)3 5309 2112
E-Mail support@sick.jp

Magyarország

Phone +36 1 371 2680
E-Mail office@sick.hu

Nederland

Phone +31 (0)30 229 25 44
E-Mail info@sick.nl

Norge

Phone +47 67 81 50 00
E-Mail sick@sick.no

Österreich

Phone +43 (0)22 36 62 28 8-0
E-Mail office@sick.at

Polska

Phone +48 22 837 40 50
E-Mail info@sick.pl

România

Phone +40 356 171 120
E-Mail office@sick.ro

Russia

Phone +7-495-775-05-30
E-Mail info@sick.ru

Schweiz

Phone +41 41 619 29 39
E-Mail contact@sick.ch

Singapore

Phone +65 6744 3732
E-Mail sales.gsg@sick.com

Slovenija

Phone +386 (0)1-47 69 990
E-Mail office@sick.si

South Africa

Phone +27 11 472 3733
E-Mail info@sickautomation.co.za

South Korea

Phone +82 2 786 6321/4
E-Mail info@sickkorea.net

Suomi

Phone +358-9-25 15 800
E-Mail sick@sick.fi

Sverige

Phone +46 10 110 10 00
E-Mail info@sick.se

Taiwan

Phone +886 2 2375-6288
E-Mail sales@sick.com.tw

Türkiye

Phone +90 (216) 528 50 00
E-Mail info@sick.com.tr

United Arab Emirates

Phone +971 (0) 4 88 65 878
E-Mail info@sick.ae

USA/México

Phone +1(952) 941-6780
1 (800) 325-7425 – tollfree
E-Mail info@sickusa.com

More representatives and agencies
at www.sick.com