



Photoelectric sensors
W9L-3, Photoelectric retro-reflective sensor,
autocollimation

WL9M4L-3P2232



Model Name > [WL9M4L-3P2232](#)
Part No. > [1058227](#)

At a glance

- Tough VISTAL™ housing
- Precise laser light spot
- Laser class 1
- Autocollimation optics and polarizing filter
- Teach-in
- Optimized SICK ASIC technology
- Connections: M8 and M12 plugs, cable as well as cable with plug
- M4 hole pattern

Your benefits

- Precise detection of small objects and object features
- Detection of objects even through small openings
- Less machine downtime thanks to the stable VISTAL™ housing
- The longest sensing ranges in its class
- No blind spots, also detects shiny objects
- Wide range of connection options
- Multiple mounting options
- Highly visible light spot simplifies alignment



Illustration may differ



Features

Sensor/detection principle:	Photoelectric retro-reflective sensor, autocollimation
Dimensions (W x H x D):	12.2 mm x 49.8 mm x 23.6 mm
Housing design (light emission):	Rectangular
Mounting hole:	M4
Sensing range max.:	0 m ... 12 m ¹⁾
Sensing range:	0 m ... 8 m ²⁾
Type of light:	Visible red light
Light source:	Laser ³⁾
Laser class:	1, 1 (IEC 60825-1/CDRH 21 CFR 1040.10 & 1040.11)
Adjustment:	Single teach-in button
Light spot size (distance):	Ø 1 mm (500 mm)

^{1) 2)} PL80A ³⁾ Average service life 50,000 h at T_A = +25 °C

Mechanics/electronics

Supply voltage:	10 V DC ... 30 V DC ¹⁾
Ripple:	< 5 Vpp ²⁾
Power consumption:	≤ 30 mA ³⁾
Output type:	PNP ⁴⁾
Output function:	Complementary
Switching mode:	Light/dark switching ⁵⁾
Output current I _{max.} :	≤ 100 mA
Response time:	≤ 0.5 ms ⁶⁾
Switching frequency:	1,000 Hz ⁷⁾
Connection type:	Connector M8, 4-pin
Circuit protection:::	A, B, C ^{8) 9) 10)}
Protection class:	III
Weight:	13 g
Polarisation filter:	✓
Optics material:	PMMA
Enclosure rating:	IP 66 IP 67 IP 69K
Ambient operating temperature:	-10 °C ... +50 °C
Ambient storage temperature:	-30 °C ... +70 °C
Ambient operating temperature extended:::	-30 °C ... +55 °C ^{11) 12)}
UL File No.:	NRKH.E181493
Housing material:	Plastic, VISTAL

¹⁾ Limit values, operation in short-circuit protected network max. 8 A ²⁾ May not exceed or fall short of V_S tolerances ³⁾ Without load ^{4) 5)} Q = light-switching ⁶⁾ Signal transit time with resistive load ⁷⁾ With light/dark ratio 1:1 ⁸⁾ A = V_S connections reverse-polarity protected ⁹⁾ B = inputs and output reverse-polarity protected ¹⁰⁾ C = interference suppression ¹¹⁾ As of T_a = 50 °C, a max. supply voltage V_{max.} = 24 V and a max. load current I_{max.} = 50 mA is permitted ¹²⁾ Using the sensor below T_a = -10 °C is possible, if the sensor is turned on at T_a > -10 °C, then the environment cools down and the sensor is not disconnected from the supply voltage during the whole time. It is not allowed to turn on the sensor below T_a = -10 °C

Dimensional drawing

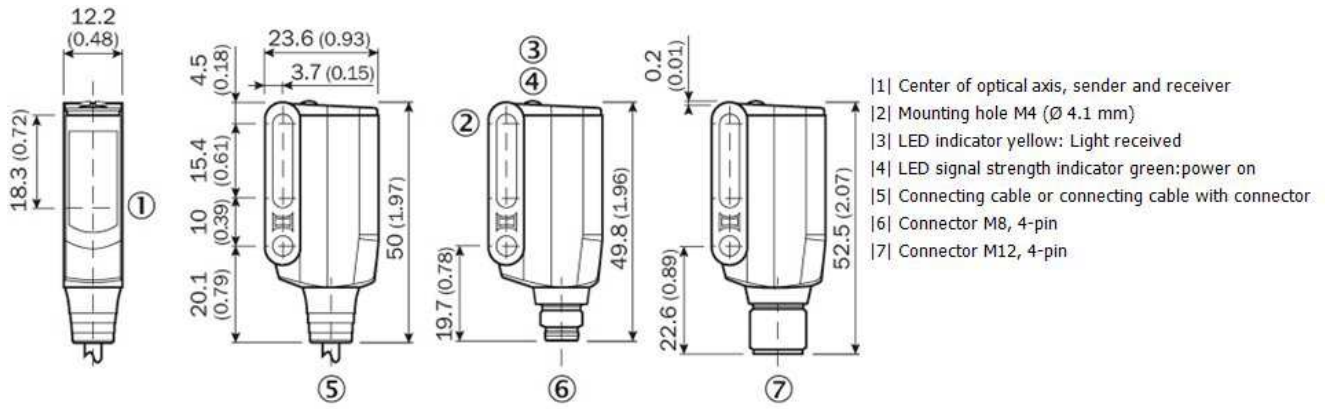

Adjustments possible

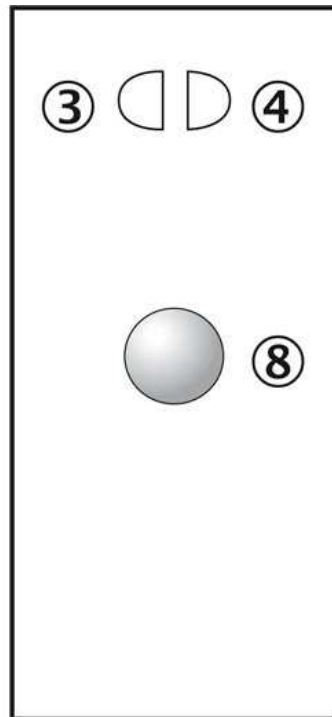

- |3| LED indicator yellow: Light received
- |4| LED signal strength indicator green:power on
- |8| Teach-in button

Connection diagram

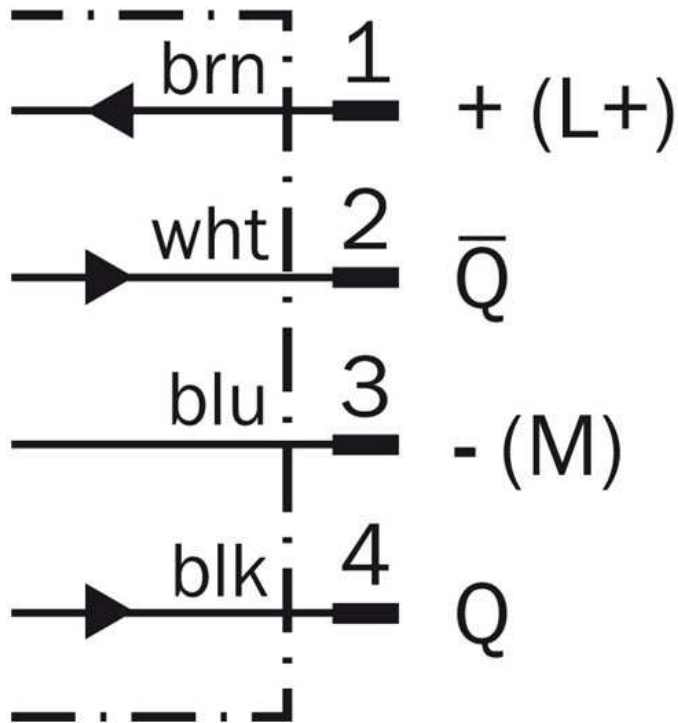

Characteristic curve

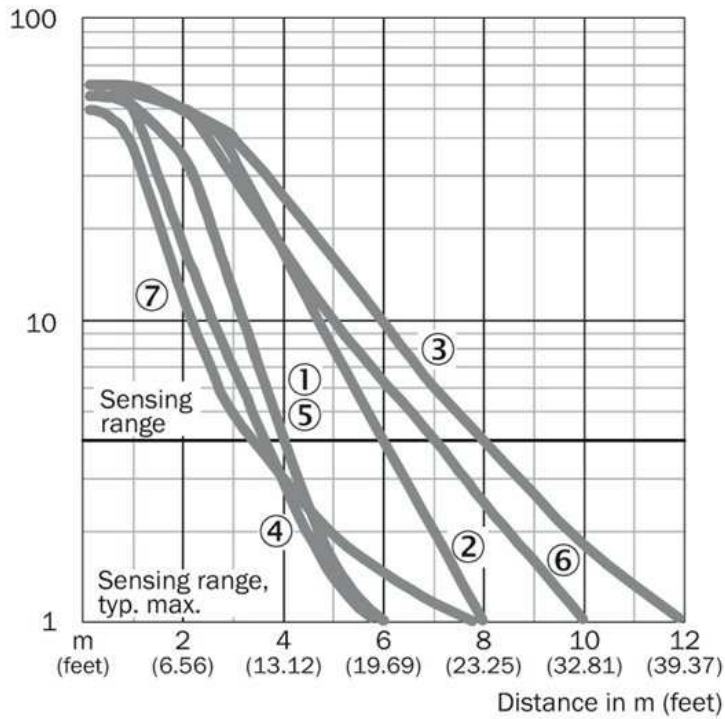

- |1| PL20A
- |2| PL40A
- |3| PL80A
- |4| PL10F
- |5| PL20F
- |6| P250F
- |7| REF-AC1000

Light spot size

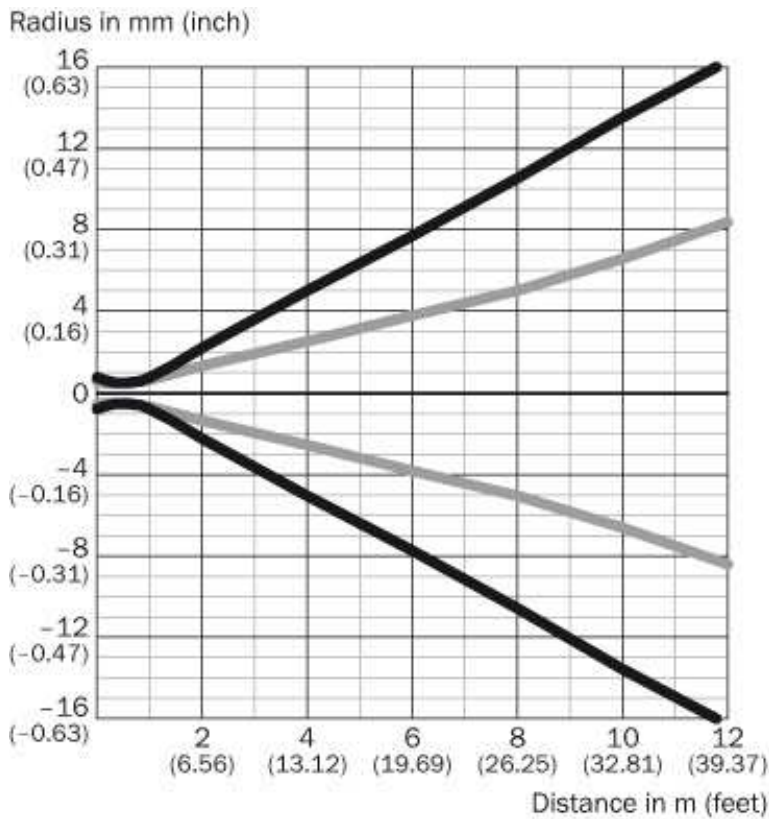

Dimensions in mm (inch)

Sensing range	Vertical	Horizontal
0.5 m (1.64 feet)	< 1.0 (0.04)	< 1.0 (0.04)
1 m (3.28 feet)	1.5 (0.06)	1.2 (0.05)
6 m (19.69 feet)	15.2 (0.60)	7.6 (0.30)
12 m (39.37 feet)	32.4 (1.28)	16.4 (0.65)

Sensing range diagram

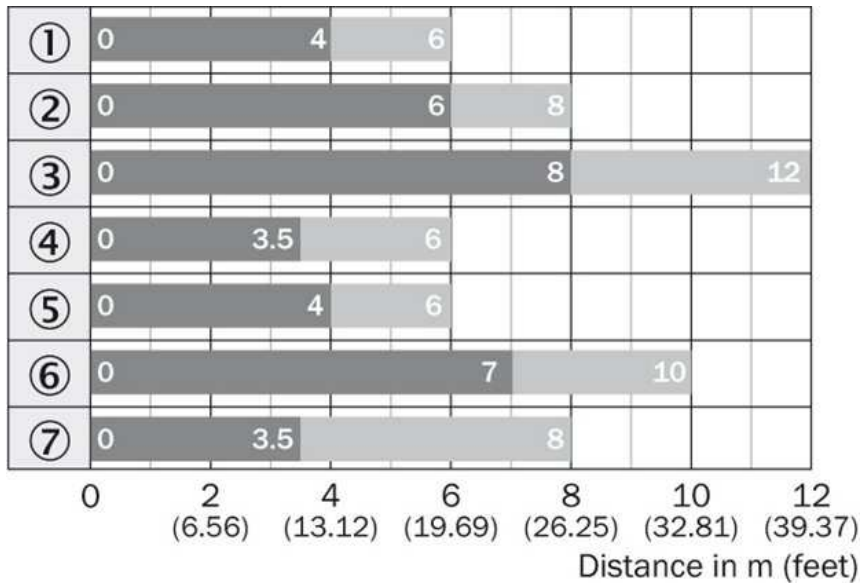

- [1] PL20A
- [2] PL40A
- [3] PL80A
- [4] PL10F
- [5] PL20F
- [6] P250F
- [7] REF-AC1000

■ Sensing range ■ Sensing range typ. max.

Lichtfleckgröße (Detailansicht)

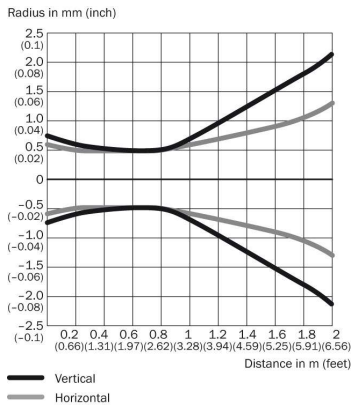

Australia

Phone +61 3 9457 0600
1800 33 48 02 – tollfree
E-Mail sales@sick.com.au

Belgium/Luxembourg

Phone +32 (0)2 466 55 66
E-Mail info@sick.be

Brasil

Phone +55 11 3215-4900
E-Mail marketing@sick.com.br

Canada

Phone +1 905 771 14 44
E-Mail information@sick.com

Česká republika

Phone +420 2 57 91 18 50
E-Mail sick@sick.cz

China

Phone +86 4000 121 000
E-Mail info.china@sick.net.cn
Phone +852-2153 6300
E-Mail ghk@sick.com.hk

Danmark

Phone +45 45 82 64 00
E-Mail sick@sick.dk

Deutschland

Phone +49 211 5301-301
E-Mail info@sick.de

España

Phone +34 93 480 31 00
E-Mail info@sick.es

France

Phone +33 1 64 62 35 00
E-Mail info@sick.fr

Great Britain

Phone +44 (0)1727 831121
E-Mail info@sick.co.uk

India

Phone +91-22-4033 8333
E-Mail info@sick-india.com

Israel

Phone +972-4-6881000
E-Mail info@sick-sensors.com

Italia

Phone +39 02 27 43 41
E-Mail info@sick.it

Japan

Phone +81 (0)3 5309 2112
E-Mail support@sick.jp

Magyarország

Phone +36 1 371 2680
E-Mail office@sick.hu

Nederland

Phone +31 (0)30 229 25 44
E-Mail info@sick.nl

Norge

Phone +47 67 81 50 00
E-Mail sick@sick.no

Österreich

Phone +43 (0)22 36 62 28 8-0
E-Mail office@sick.at

Polska

Phone +48 22 837 40 50
E-Mail info@sick.pl

România

Phone +40 356 171 120
E-Mail office@sick.ro

Russia

Phone +7-495-775-05-30
E-Mail info@sick.ru

Schweiz

Phone +41 41 619 29 39
E-Mail contact@sick.ch

Singapore

Phone +65 6744 3732
E-Mail sales.gsg@sick.com

Slovenija

Phone +386 (0)1-47 69 990
E-Mail office@sick.si

South Africa

Phone +27 11 472 3733
E-Mail info@sickautomation.co.za

South Korea

Phone +82 2 786 6321/4
E-Mail info@sickkorea.net

Suomi

Phone +358-9-25 15 800
E-Mail sick@sick.fi

Sverige

Phone +46 10 110 10 00
E-Mail info@sick.se

Taiwan

Phone +886 2 2375-6288
E-Mail sales@sick.com.tw

Türkiye

Phone +90 (216) 528 50 00
E-Mail info@sick.com.tr

United Arab Emirates

Phone +971 (0) 4 88 65 878
E-Mail info@sick.ae

USA/México

Phone +1(952) 941-6780
1 (800) 325-7425 – tollfree
E-Mail info@sickusa.com

More representatives and agencies
at www.sick.com