



Photoelectric sensors
W4SL-3V, Through-beam photoelectric sensor

WSE4SL-3P2437V



Model Name > [WSE4SL-3P2437V](#)
Part No. > [1058269](#)



Illustration may differ

At a glance

- Precise laser light spot, laser class 1
- Stainless steel housing with washdown design
- Latest SICK proprietary ASIC and laser technologies for very good background suppression and ambient light immunity
- ECOLAB certified, tested to IP66, IP67, IP68 and IP69K enclosure rating
- State-of-the-art connections through 100 % sealed electronics
- Patented teach-in pushbutton consisting of a stainless steel membrane welded into the housing

Your benefits

- Highly visible, even light spot with a sharp contour to facilitate alignment
- Washable stainless steel housing reduces bacterial contamination
- Innovative washdown design with sealed connections and unique patented membrane teach-in pushbutton
- High level of system availability and minimal operating costs even when aggressive cleaners are used, thanks to high-quality manufacturing and inspection
- Long sensing range allows use from up to 60 m
- Sender-receiver system ensures high reliability
- Established and proven housing design for easy installation



Features

Sensor/detection principle:	Through-beam photoelectric sensor
Dimensions (W x H x D):	15.3 mm x 55.4 mm x 22.2 mm
Housing design:	Washdown ¹⁾
Housing design (light emission):	Rectangular
Mounting hole:	M3
Sensing range max.:	0 m ... 60 m
Sensing range:	0 m ... 50 m
Type of light:	Visible red light
Light source:	Laser ²⁾
Laser class:	1 (EN60825-1:2008-05 & IEC 60825-1:2007-03/CDRH 21 CFR 1040.10 & 1040.11)
Wave length:	650 nm
Adjustment:	Single teach-in button
Light spot size (distance):	Ø 1 mm (500 mm)

¹⁾ The essential difference between a standard/washdown product and a hygiene product is that where the process and contact with the medium (activity in the vicinity of the food) are concerned, the product is designed in accordance with the latest standards and hygiene design guidelines, and materials are selected accordingly ²⁾

Average service life 50,000 h at $T_A = +25\text{ °C}$

Mechanics/electronics

Supply voltage:	10 V DC ... 30 V DC ¹⁾
Ripple:	< 5 Vpp ²⁾
Power consumption:	≤ 30 mA ³⁾
Output type:	PNP ⁴⁾
Output function:	Complementary
Switching mode:	Light/dark switching ⁵⁾
Output current I _{max.} :	≤ 100 mA
Response time:	≤ 0.5 ms ⁶⁾
Switching frequency:	1,000 Hz ⁷⁾
Connection type:	Connector M12, 4-pin ⁸⁾
Circuit protection:::	A, B, C ^{9) 10) 11)}
Protection class:	III
Weight:	45 g
Housing material:	Stainless steel, Stainless steel V4A (1.4404, 316L)
Optics material:	PMMA
Enclosure rating:	IP 66, IP 67, IP 68, IP 69K ¹²⁾
Ambient operating temperature:	-10 °C ... +50 °C
Ambient storage temperature:	-30 °C ... +70 °C
Ambient operating temperature extended:::	-30 °C ... +55 °C ^{13) 14)}

¹⁾ Limit values, operation in short-circuit protected network max. 8 A ²⁾ May not exceed or fall short of V_S tolerances ³⁾ Without load ^{4) 5)} Q = light-switching ⁶⁾ Signal transit time with resistive load ⁷⁾ With light/dark ratio 1:1 ⁸⁾ Tightening torque, max.: 0.7 Nm ⁹⁾ A = V_S connections reverse-polarity protected ¹⁰⁾ B = inputs and output reverse-polarity protected ¹¹⁾ C = interference suppression ¹²⁾ Only in case of correctly mounted IP 69K connecting cable ¹³⁾ As of $T_a = 50\text{ °C}$, a max. supply voltage $V_{max.} = 24\text{ V}$ and a max. load current $I_{max.} = 50\text{ mA}$ is permitted ¹⁴⁾ Using the sensor below $T_a = -10\text{ °C}$ is possible, if the sensor is turned on at $T_a > -10\text{ °C}$, then the environment cools down and the sensor is not disconnected from the supply voltage during the whole time. It is not allowed to turn on the sensor below $T_a = -10\text{ °C}$

Dimensional drawing

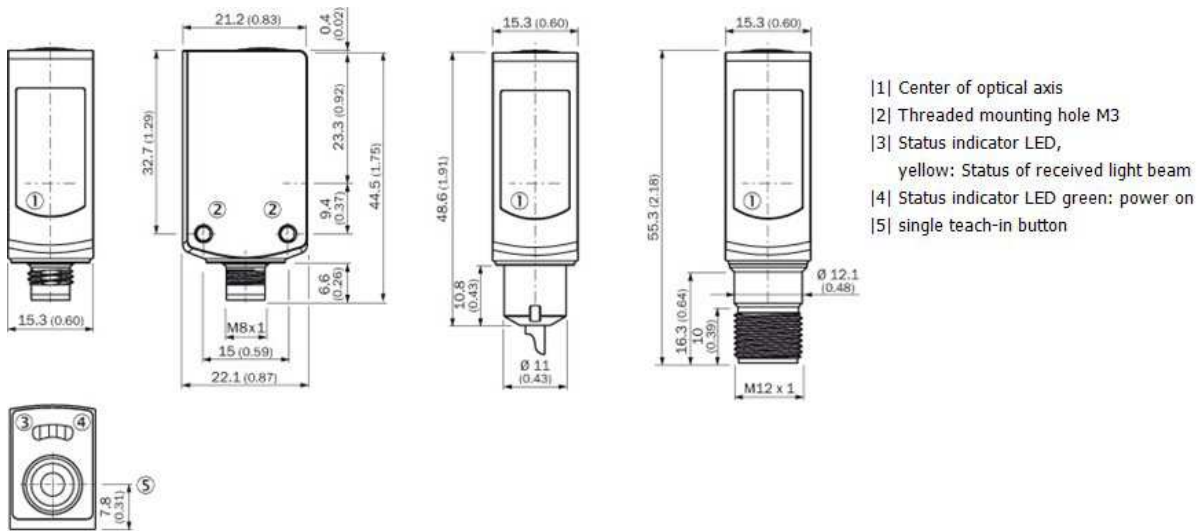

Connection diagram

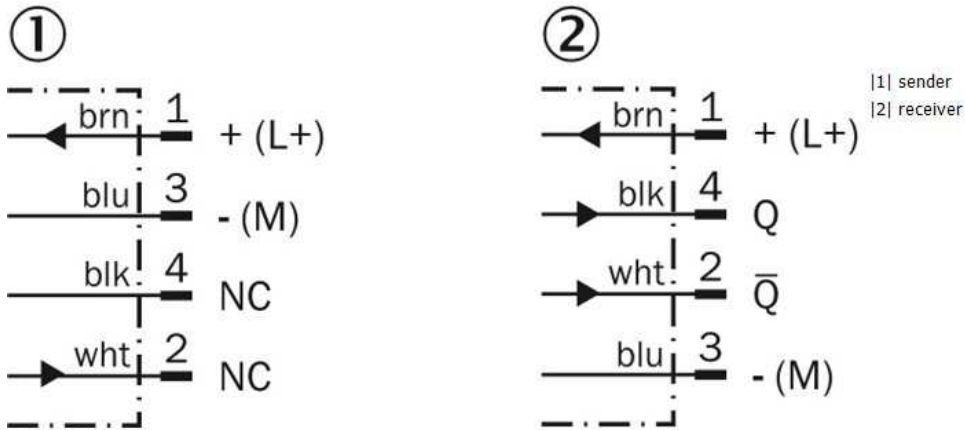

Characteristic curve

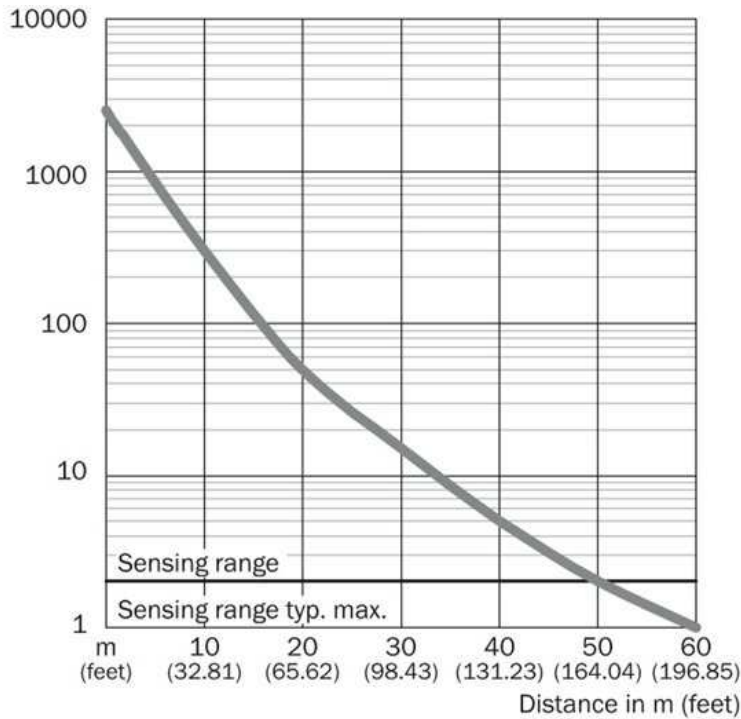

Light spot size

Radius in mm (inch)

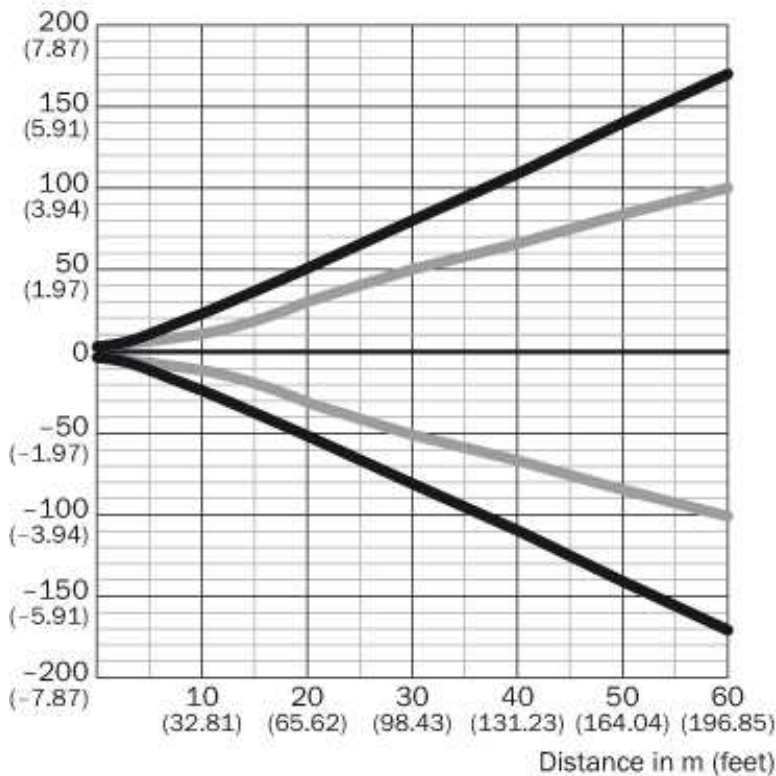

Dimensions in mm (inch)

Sensing range	Vertical	Horizontal
0.5 m (1.64 feet)	< 1.0 (0.04)	< 1.0 (0.04)
1 m (3.28 feet)	1.5 (0.06)	1.2 (0.05)
5 m (16.40 feet)	15 (0.59)	11 (0.43)
10 m (32.81 feet)	45 (1.77)	28 (1.10)
60 m (196.85 feet)	336 (13.23)	200 (7.87)

Vertical
 Horizontal

Sensing range diagram

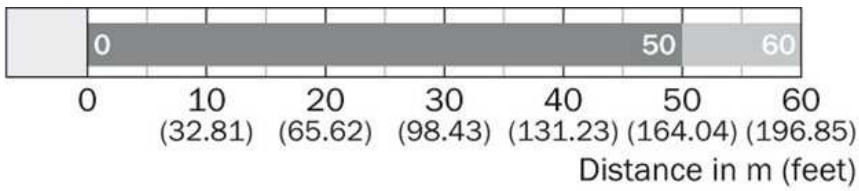

■ Sensing range ■ Sensing range typ. max.

Lichtfleckgröße (Detailansicht)

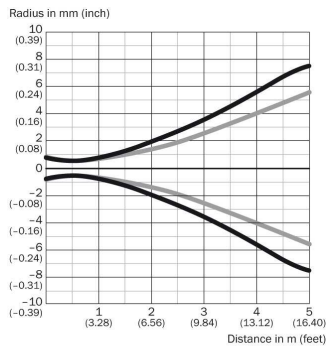

— Vertical
 — Horizontal

Light spot size (Close up)

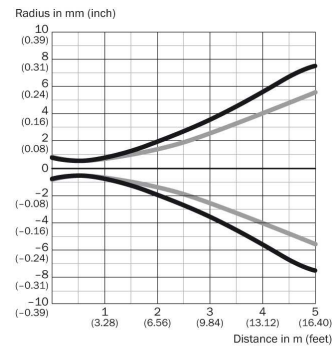

— Vertical
 — Horizontal

Australia

Phone +61 3 9457 0600
1800 33 48 02 – tollfree
E-Mail sales@sick.com.au

Belgium/Luxembourg

Phone +32 (0)2 466 55 66
E-Mail info@sick.be

Brasil

Phone +55 11 3215-4900
E-Mail marketing@sick.com.br

Canada

Phone +1 905 771 14 44
E-Mail information@sick.com

Česká republika

Phone +420 2 57 91 18 50
E-Mail sick@sick.cz

China

Phone +86 4000 121 000
E-Mail info.china@sick.net.cn
Phone +852-2153 6300
E-Mail ghk@sick.com.hk

Danmark

Phone +45 45 82 64 00
E-Mail sick@sick.dk

Deutschland

Phone +49 211 5301-301
E-Mail info@sick.de

España

Phone +34 93 480 31 00
E-Mail info@sick.es

France

Phone +33 1 64 62 35 00
E-Mail info@sick.fr

Great Britain

Phone +44 (0)1727 831121
E-Mail info@sick.co.uk

India

Phone +91-22-4033 8333
E-Mail info@sick-india.com

Israel

Phone +972-4-6881000
E-Mail info@sick-sensors.com

Italia

Phone +39 02 27 43 41
E-Mail info@sick.it

Japan

Phone +81 (0)3 5309 2112
E-Mail support@sick.jp

Magyarország

Phone +36 1 371 2680
E-Mail office@sick.hu

Nederland

Phone +31 (0)30 229 25 44
E-Mail info@sick.nl

Norge

Phone +47 67 81 50 00
E-Mail sick@sick.no

Österreich

Phone +43 (0)22 36 62 28 8-0
E-Mail office@sick.at

Polska

Phone +48 22 837 40 50
E-Mail info@sick.pl

România

Phone +40 356 171 120
E-Mail office@sick.ro

Russia

Phone +7-495-775-05-30
E-Mail info@sick.ru

Schweiz

Phone +41 41 619 29 39
E-Mail contact@sick.ch

Singapore

Phone +65 6744 3732
E-Mail sales.gsg@sick.com

Slovenija

Phone +386 (0)1-47 69 990
E-Mail office@sick.si

South Africa

Phone +27 11 472 3733
E-Mail info@sickautomation.co.za

South Korea

Phone +82 2 786 6321/4
E-Mail info@sickkorea.net

Suomi

Phone +358-9-25 15 800
E-Mail sick@sick.fi

Sverige

Phone +46 10 110 10 00
E-Mail info@sick.se

Taiwan

Phone +886 2 2375-6288
E-Mail sales@sick.com.tw

Türkiye

Phone +90 (216) 528 50 00
E-Mail info@sick.com.tr

United Arab Emirates

Phone +971 (0) 4 88 65 878
E-Mail info@sick.ae

USA/México

Phone +1(952) 941-6780
1 (800) 325-7425 – tollfree
E-Mail info@sickusa.com

More representatives and agencies
at www.sick.com