



Incremental encoders DFS60, Rotary

DFS60B-S4EB00500



Model Name > [DFS60B-S4EB00500](#)
Part No. > [1059346](#)



Illustration may differ

At a glance

- Compact installation depth
- High resolution up to 16 bits
- Optionally programmable: Output voltage, zero pulse position, zero pulse width and number of pulses
- Connection: Radial or axial cable outlet, M23 or M12 connector, axial or radial
- Electrical interfaces: 5V & 24V TTL/RS-422, 24 V HTL/push pull
- Mechanical interfaces: face mount or servo flange, blind or through hollow shaft
- Remote zero set possible

Your benefits

- Reduced storage costs and downtime due to customer-specific programming
- Variety of different mechanical and electrical interfaces enable the encoder to be optimally adjusted to fit the installation situation
- Excellent concentricity even at high speeds
- High resolution of up to 16 bits ensures precise measurements
- Permanent and safe operation due to a high enclosure rating, temperature resistance and a long bearing lifetime
- Programmability via the PGT-08 programming software and the PGT-10-S display programming tool allow the encoder to be adapted flexibly and quickly according to customer needs
- Programmable zero pulse position simplifies installation



Performance

Error limits:	± 0.05 °
Measuring step:	90 °/electronically/number of lines
Initialization time:	40 ms
Pulses per revolution:	500

Mechanical data

Mechanical interface:	Solid shaft, Face mount flange
Shaft diameter:	10 mm x 19 mm
Mass:	0.3 kg
Start up torque:	0.5 Ncm (+20 °C)
Operating torque:	0.3 Ncm (+20 °C)
Maximum operating speed:	10,000 /min
Moment of inertia of the rotor:	6.2 gcm ²
Bearing lifetime:	3.6 x 10 ¹⁰ revolutions

Max. angular acceleration: 500,000 rad/s²
Permissible shaft loading radial/axial: 40 N (axial), 80 N (radial)

Electrical data

Electrical interface: 10 V ... 32 V, HTL/Push pull, Connector M23, 12-pin, axial
Connection type: Connector M23, 12-pin, axial
Maximum output frequency: 600 kHz
Reference signal, number: 1
Reference signal, position: 90 °, electronically, gated with A and B
Operating voltage range: 10 V ... 32 V
Load current max.: 30 mA
Power consumption: 0.5 W (without load)
MTTFd: mean time to dangerous failure: 300 a (EN ISO 13849-1) ¹⁾

¹⁾ This product is a standard product and does not constitute a safety component as defined in the Machinery Directive.

Calculation based on nominal load of components, average ambient

temperature 40°C, frequency of use 8760 h/a. All

electronic failures are considered hazardous. For more information, see document no. 8015532.

Ambient data

EMC: (according to EN 61000-6-2 and EN 61000-6-3)
Working temperature range: -30 °C ... +100 °C
Storage temperature range: -40 °C ... +100 °C, without package
Resistance to shocks: 70 g (according to EN 60068-2-27)
Resistance to vibration: 30 g, 10 Hz ... 2,000 Hz (according to EN 60068-2-6)
Enclosure rating: IP 65 (according to IEC 60529), shaft side, IP 67 (according to IEC 60529), housing side
Permissible relative humidity: 90 % (condensation of the optical scanning not permitted)

¹⁾ With mating connector fitted

Dimensional drawing

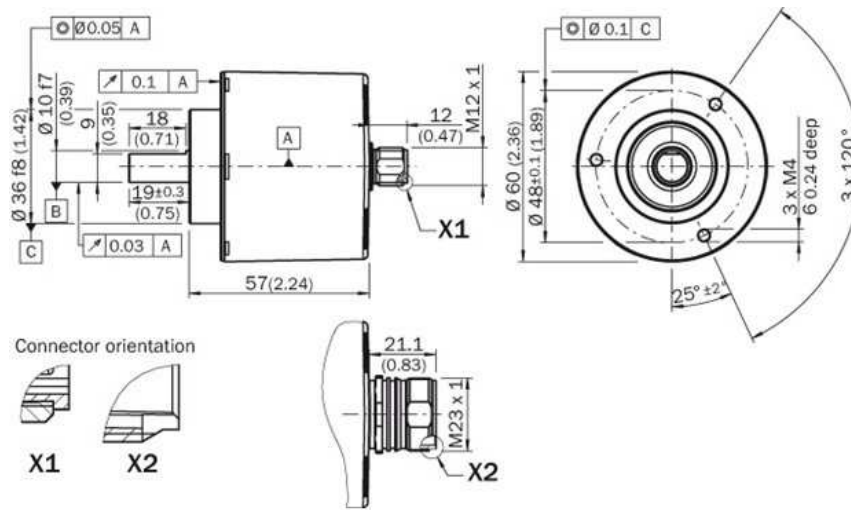

PIN assignment

5-core cable

View of M12 device connector on encoder



View of M23 device connector on encoder



PIN, 8-pin, M12 connector	PIN, 12-pin, M23 connector	Core colors of encoders with cable outlet	TTL/HTL signal	Explanation
1	6	Brown	A	Signal cable
2	5	White	A	Signal cable
3	1	Black	B	Signal cable
4	8	Pink	B	Signal cable
5	4	Yellow	Z	Signal cable
6	3	Lilac	Z	Signal cable
7	10	Blue	GND	Ground connection of the encoder
8	12	Red	+U _s	Supply voltage (volt-free to housing)
-	9	-	N.C.	Not assigned
-	2	-	N.C.	Not assigned
-	11	-	N.C.	Not assigned
-	7 ^a	-	SET	Zero pulse teach
Shield	Shield	Shield	Shield	Shield connected to housing on side of encoder. Connected to ground on side of control.

^a Only at 4.5 ... 32 V, TTL/HTL programmable

The SET input serves to carry out the zero pulse teach function. If the SET input is applied to U_s for longer than 250 ms, after it has been open for at least 1,000 ms or applied to GND, the current shaft position is assigned the zero pulse signal "Z".

Image Unavailable

Drehzahlbetrachtung



Australia

Phone +61 3 9457 0600
1800 33 48 02 – tollfree
E-Mail sales@sick.com.au

Belgium/Luxembourg

Phone +32 (0)2 466 55 66
E-Mail info@sick.be

Brasil

Phone +55 11 3215-4900
E-Mail marketing@sick.com.br

Canada

Phone +1 905 771 14 44
E-Mail information@sick.com

Česká republika

Phone +420 2 57 91 18 50
E-Mail sick@sick.cz

China

Phone +86 4000 121 000
E-Mail info.china@sick.net.cn
Phone +852-2153 6300
E-Mail ghk@sick.com.hk

Danmark

Phone +45 45 82 64 00
E-Mail sick@sick.dk

Deutschland

Phone +49 211 5301-301
E-Mail info@sick.de

España

Phone +34 93 480 31 00
E-Mail info@sick.es

France

Phone +33 1 64 62 35 00
E-Mail info@sick.fr

Great Britain

Phone +44 (0)1727 831121
E-Mail info@sick.co.uk

India

Phone +91-22-4033 8333
E-Mail info@sick-india.com

Israel

Phone +972-4-6881000
E-Mail info@sick-sensors.com

Italia

Phone +39 02 27 43 41
E-Mail info@sick.it

Japan

Phone +81 (0)3 5309 2112
E-Mail support@sick.jp

Magyarország

Phone +36 1 371 2680
E-Mail office@sick.hu

Nederland

Phone +31 (0)30 229 25 44
E-Mail info@sick.nl

Norge

Phone +47 67 81 50 00
E-Mail sick@sick.no

Österreich

Phone +43 (0)22 36 62 28 8-0
E-Mail office@sick.at

Polska

Phone +48 22 837 40 50
E-Mail info@sick.pl

România

Phone +40 356 171 120
E-Mail office@sick.ro

Russia

Phone +7-495-775-05-30
E-Mail info@sick.ru

Schweiz

Phone +41 41 619 29 39
E-Mail contact@sick.ch

Singapore

Phone +65 6744 3732
E-Mail sales.gsg@sick.com

Slovenija

Phone +386 (0)1-47 69 990
E-Mail office@sick.si

South Africa

Phone +27 11 472 3733
E-Mail info@sickautomation.co.za

South Korea

Phone +82 2 786 6321/4
E-Mail info@sickkorea.net

Suomi

Phone +358-9-25 15 800
E-Mail sick@sick.fi

Sverige

Phone +46 10 110 10 00
E-Mail info@sick.se

Taiwan

Phone +886 2 2375-6288
E-Mail sales@sick.com.tw

Türkiye

Phone +90 (216) 528 50 00
E-Mail info@sick.com.tr

United Arab Emirates

Phone +971 (0) 4 88 65 878
E-Mail info@sick.ae

USA/México

Phone +1(952) 941-6780
1 (800) 325-7425 – tollfree
E-Mail info@sickusa.com

More representatives and agencies
at www.sick.com