



Magnetic Cylinder Sensors
Analog positioning sensors

MPA-467THTP0



Model Name > [MPA-467THTP0](#)
Part No. > [1059462](#)



At a glance

- Analog positioning sensor that can be mounted with adapters on various cylinders thanks to its universal housing, e.g., cylinders with T-slot, round and tie rod cylinders
- Measuring lengths from 107 mm to 1,007 mm in 36 mm steps
- Output signals 4 mA to 20 mA as well as 0 V to 10 V in a single sensor
- Linearity of 0.5 mm at a sample rate of 1.15 ms and an resolution of 0.06 mm
- Electric setting of zero point and end point via teach-in button
- IP 67 enclosure rating

Your benefits

- Maximum flexibility through measuring ranges from 107 mm to 1,007 mm
- Increased machine performance thanks to the sensor's minimal blind zone
- Saves time due to configurable start and end points via intelligent Teach Pad
- A rugged aluminum housing, the capacitive Teach Pad and the anti-kink cable guarantees a long operational lifetime of the sensor and reduces maintenance costs
- Time savings through simple commissioning and diagnostics thanks to a 4-color LED display
- Analog power, voltage signal and IO-Link in a single sensor reduces the range of variants and thereby lowers warehousing costs
- Flexible sensor settings, monitoring, advanced diagnostics, and visualization thanks to IO-Link save time and money



Features

Output function:	Analog, IO-Link
Electrical wiring:	DC 4-wire
Teach-in:	1
Cylinder types with adapter:	Roundbody cylinder T-slot Tie rod cylinder
Measurement range:	467 mm ¹⁾
Housing length:	469 mm
Analog output (voltage):	0 V ... 10 V
Analog output (current):	4 mA ... 20 mA
Enclosure rating:	IP 65 IP 67 ²⁾ IP 68
IO-Link functions:	Standard functions

1) ± 1 mm 2) According to EN 60529

Mechanics/electronics

Connection type:	Cable with connector M8, 4-pin, 0.3 m ¹⁾
Supply voltage:	15 V DC ... 30 V DC
EMC:	According to EN 60947-5-2 ²⁾
Load resistance, max.:	500 Ω ³⁾
Min. load resistance:	2 k Ω ⁴⁾
Cable material:	PUR
Conductor cross-section:	0.14 mm ²
Reverse polarity protection:	✓
Short-circuit protection:	✓
Housing cap material:	PA, strengthened
IO-Link:	✓
Output indicator:	✓
Linearity typ.:	0.5 mm
Resolution typ.:	0.03 % FSR (max. ≥ 0.06 mm) ⁵⁾
Repeat accuracy typ.:	0.06 % FSR (≥ 0.1 mm) ⁶⁾
Shock and vibration resistance:	30 g, 11 ms/10 Hz ... 55 Hz, 1 mm
Ambient operating temperature:	-20 °C ... +70 °C
Protection class:	III
Magnetic field sensitivity, typ.:	2 mT
Sampling rate typ.:	1.15 ms
Housing material:	Aluminum

1) Do not bend below 0 °C 2) The analog measured value can deviate under transient conditions 3) Power output 4) Voltage output 5) 6) FSR: Full Scale Range; max. measuring range

Dimensional drawing

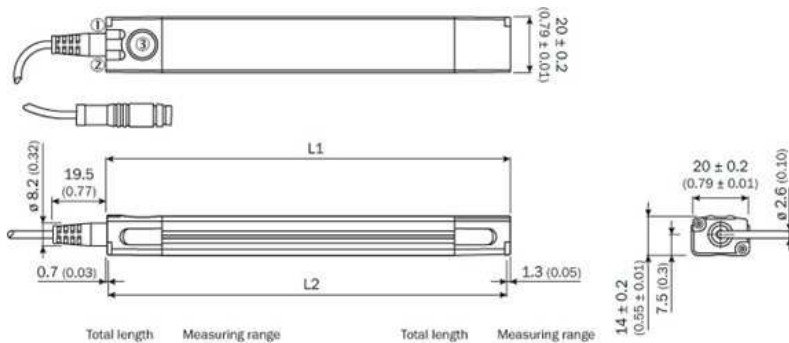

- |1| Function signal indicator 1
- |2| Function signal indicator 2
- |3| Teach-Pad

	Total length (L1) mm	Measuring range (L2) mm		Total length (L1) mm	Measuring range (L2) mm
MPA-107	109	107	MPA-575	577	575
MPA-143	145	143	MPA-611	613	611
MPA-179	181	179	MPA-647	649	647
MPA-215	217	215	MPA-683	685	683
MPA-251	253	251	MPA-719	721	719
MPA-287	289	287	MPA-755	757	755
MPA-323	325	323	MPA-791	793	791
MPA-359	361	359	MPA-827	829	827
MPA-395	397	395	MPA-863	865	863
MPA-431	433	431	MPA-899	901	899
MPA-467	469	467	MPA-935	937	935
MPA-503	505	503	MPA-971	973	971
MPA-539	541	539	MPA-1007	1,009	1,007

Connection diagram

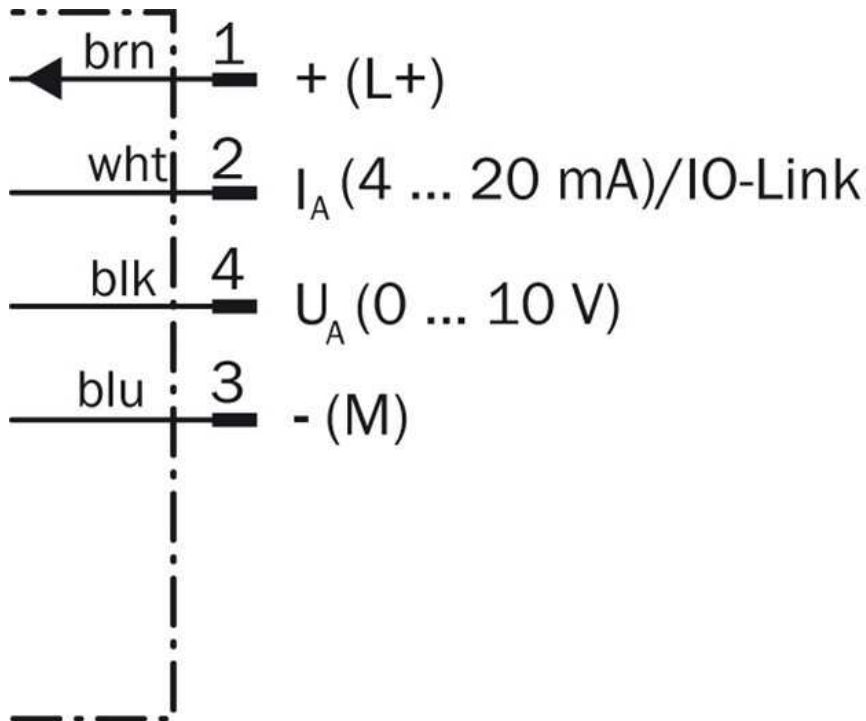

Australia

Phone +61 3 9457 0600
1800 33 48 02 – tollfree
E-Mail sales@sick.com.au

Belgium/Luxembourg

Phone +32 (0)2 466 55 66
E-Mail info@sick.be

Brasil

Phone +55 11 3215-4900
E-Mail marketing@sick.com.br

Canada

Phone +1 905 771 14 44
E-Mail information@sick.com

Česká republika

Phone +420 2 57 91 18 50
E-Mail sick@sick.cz

China

Phone +86 4000 121 000
E-Mail info.china@sick.net.cn
Phone +852-2153 6300
E-Mail ghk@sick.com.hk

Danmark

Phone +45 45 82 64 00
E-Mail sick@sick.dk

Deutschland

Phone +49 211 5301-301
E-Mail info@sick.de

España

Phone +34 93 480 31 00
E-Mail info@sick.es

France

Phone +33 1 64 62 35 00
E-Mail info@sick.fr

Great Britain

Phone +44 (0)1727 831121
E-Mail info@sick.co.uk

India

Phone +91-22-4033 8333
E-Mail info@sick-india.com

Israel

Phone +972-4-6881000
E-Mail info@sick-sensors.com

Italia

Phone +39 02 27 43 41
E-Mail info@sick.it

Japan

Phone +81 (0)3 5309 2112
E-Mail support@sick.jp

Magyarország

Phone +36 1 371 2680
E-Mail office@sick.hu

Nederland

Phone +31 (0)30 229 25 44
E-Mail info@sick.nl

Norge

Phone +47 67 81 50 00
E-Mail sick@sick.no

Österreich

Phone +43 (0)22 36 62 28 8-0
E-Mail office@sick.at

Polska

Phone +48 22 837 40 50
E-Mail info@sick.pl

România

Phone +40 356 171 120
E-Mail office@sick.ro

Russia

Phone +7-495-775-05-30
E-Mail info@sick.ru

Schweiz

Phone +41 41 619 29 39
E-Mail contact@sick.ch

Singapore

Phone +65 6744 3732
E-Mail sales.gsg@sick.com

Slovenija

Phone +386 (0)1-47 69 990
E-Mail office@sick.si

South Africa

Phone +27 11 472 3733
E-Mail info@sickautomation.co.za

South Korea

Phone +82 2 786 6321/4
E-Mail info@sickkorea.net

Suomi

Phone +358-9-25 15 800
E-Mail sick@sick.fi

Sverige

Phone +46 10 110 10 00
E-Mail info@sick.se

Taiwan

Phone +886 2 2375-6288
E-Mail sales@sick.com.tw

Türkiye

Phone +90 (216) 528 50 00
E-Mail info@sick.com.tr

United Arab Emirates

Phone +971 (0) 4 88 65 878
E-Mail info@sick.ae

USA/México

Phone +1(952) 941-6780
1 (800) 325-7425 – tollfree
E-Mail info@sickusa.com

More representatives and agencies
at www.sick.com